



CATALISTINO  
WORKING CATALOGUE  
2023









# INDICE SEZIONI

SECTION INDEX









## Home+Architectural

 PARETE - WALL LIGHT - WANDLEUCHTE	6
 SOSPENSIONE - SUSPENSION LAMP - PENDELLEUCHTE	54
 PLAFONE - CEILING LIGHT - DESCKENLEUCHTE	180
 PIANTANA - FLOOR LAMP - STEHLAMP	262







## Incasso - Recessed light - Einbauleuchte

 INCASSO - RECESSED LIGHT - EINBAULEUCHTE	285
--	-----





## Profili/Profiles/Profile

 UNIVERSALI/UNIVERSAL/UNIVERSAL	329
 VELETTE LUMINOSE/WALL WASHING EFFECT/WALL WASHER-EFFEKT	341
 INCASSO CON CORNICE/RECESSED PROFILE/EINBAU PROFILE	347
 INCASSO A RASO/RECESSED WALL FLUSH EFFECT/EINBAUCHTE BÜNDIG MIT DER WAND	355
 STRIPLED IP20 / IP65	360
 ROLLE LED IP20 / IP65	361
 DRIVERS & DIMMER	362
 SCATOLE MINIMAL	363

## Outdoor

 SOSPENSIONE/HANGING LAMP/PENDELLEUCHTE	369
 PLAFONE/CEILING/DECKENLEUCHTE	375
 DROP - ACCESSORI/ACCESSORIES/ZUBEHÖR	388
 PARETE/WALL LIGHT/WANDELEUCHTE	393
 INCASSO/RECESSED/EINBAUCHTE	397
 FISSAGGIO A TERRA/GROUND FIXING/BODENBEFESTIGUNG	399





## Sistemi modulari/Modular Systems/Modulare Systeme

 SOSPENSIONE - SUSPENSION LAMP - PENDELLEUCHTE	418
 PLAFONE - CEILING LIGHT - DESCKENLEUCHTE	453
 PARETE/WALL LIGHT/WANDELEUCHTE	479
 INCASSO/RECESSED/EINBAUCHTE	483
 BINARIO/TRACK/ELEKTRIFIZIATE STROMSCHIENE	495

## Binario 48V/Track 48V/Track 48V/Gleis 48V

 BINARIO 48V/TRACK 48V/TRACK 48V/STROMSCHIENE 48V	504
--	-----

## Gestione della luce/Light Management

 BLC - Bluetooth Light Control	546
 PLC - Push Light Control	547
 RLC - Remote Light Control	548
 WLC - Wall Light Control	551

## Accessori/Accessories/Zubehör

COMPLEMENTI ELETTRICI/ELECTRICAL ACCESSORIES/ELEKTRISCHES ZUBEHÖR

 STRIPLED IP20 / IP65	562
 ROLLE LED IP20 / IP65	563
 DRIVERS CC	564
 DRIVERS CV 24/48V	565
 GUIDECAVO/CABLE GUIDE/KABELFÜHRUNG	567

COMPLEMENTI MECCANICI/MECHANICAL ACCESSORIES/MECHANISCHE ZUBEHÖR

 ROSONI / CANOPY	569
---	-----

LEGENDA

CONDIZIONI GENERALI DI VENDITA

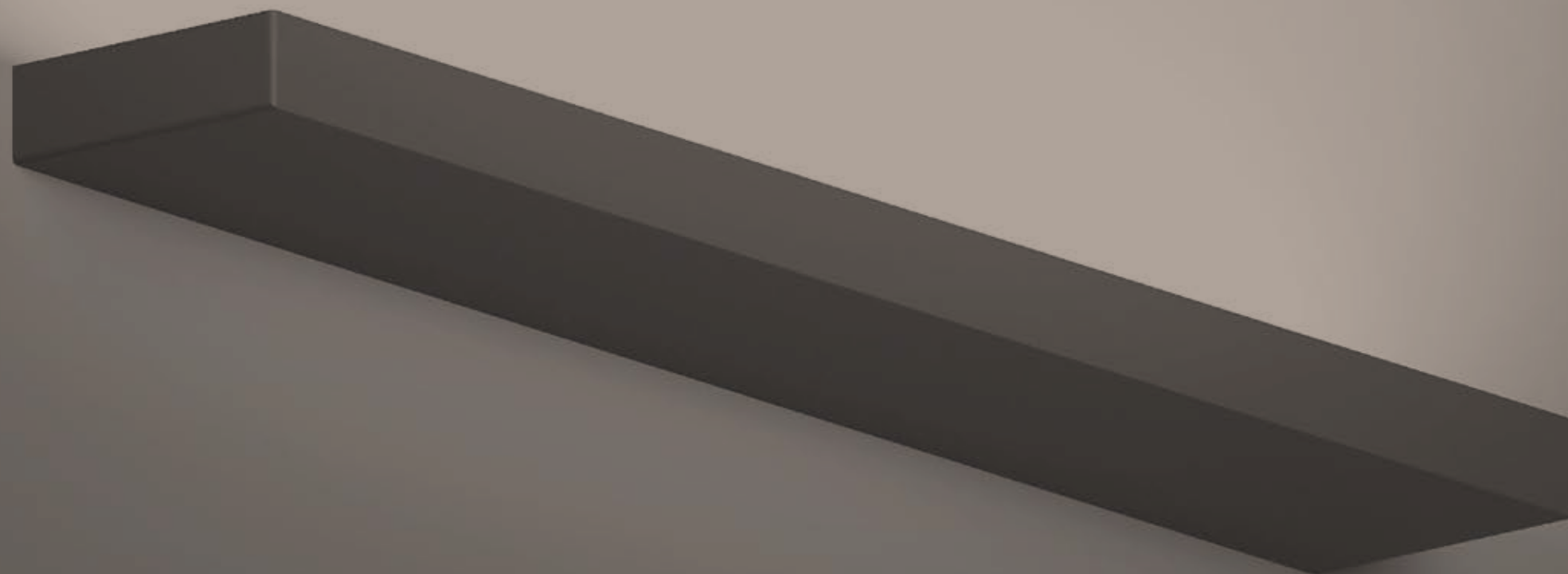

PARETE  
WALL LIGHT  
WANDLEUCHTE





**Ariell**  
uplight L17/L30/L60

9



**Ariell**  
uplight superflux L35/L120

9



**Ariell**  
up+down superflux L35/L90

11



**Bellai Home**  
up+downlight L45/L72

13



**Compact**  
omnilight L8

15



**Compact**  
omnilight L20/L35/L60

15



**Edge**  
downlight L133/L175

17



**Edge**  
downlight L22

19



**Lambda**  
downlight Ø20 H45

21



**Lambda**  
downlight Ø20 H130

23



**Leggera**  
omnilight Ø45/Ø65/Ø82

25



**Linea Dark**  
downlight L32/L60/L88/L116

27

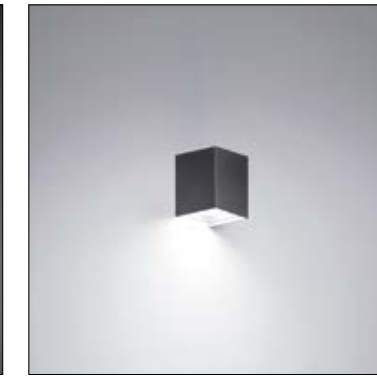

**Oki**  
downlight L7,4x7,4 H8,5

29

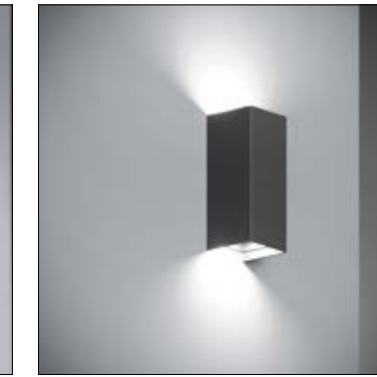

**Oki**  
up+downlight L7,5x7,5 H18

29



**Omnia**  
diffusa L28/L56

31

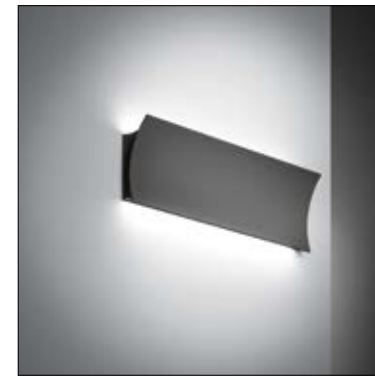

**Orizzonte**  
up+downlight L12,5/L25/L63,5/L93

33

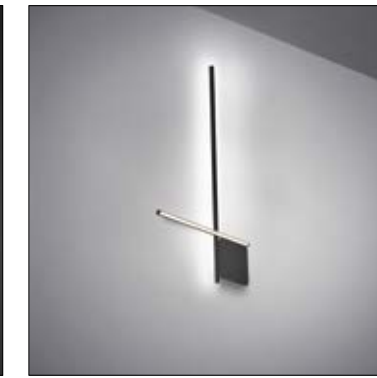

**Overlap**  
back+front light H90xL45

35



**Riflessa**  
uplight L20/45

37

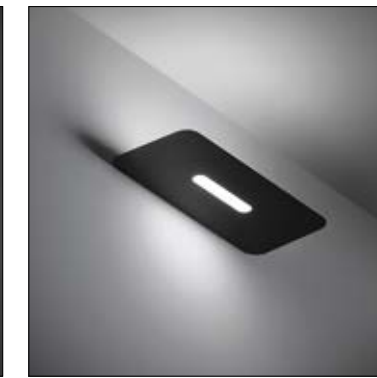

**Riflessa**  
uplight + downlight L45

37

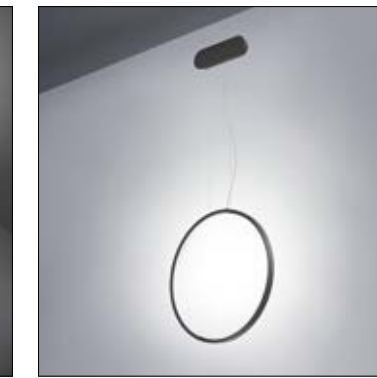

**Shadow**  
verticale Ø58/Ø70/Ø95

39



**Simply**  
up+downlight L17/L30/L60/L114/ L170

41-43



**Simply Up**  
uplight L17/L30/L60/L114

45-47



**Tao**  
up+downlight L25/L50/L75

49



**Velata**  
Wall Light Ø35/ Ø45

51

configurazione standard: / basic configuration: / Standard Konfiguration:

E28 Satinato  
Frosted - Satinert

● B 3000K

BV

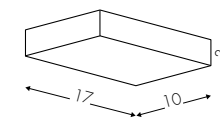

**2026BOFBVE28B** 9W 1350lm\* - 220V **151,00 €**  
**2026BTFBVE28B** 9W 1350lm - 220V **179,00 €**

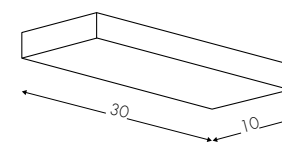

**2026DOFBVE28B** 21W 3000lm - 220V **221,00 €**  
**2026DDMBVE28B** DALI (Push) - 21W 3000lm - 220V **276,00 €**  
**2026DTFBVE28B** 21W 3000lm - 220V **276,00 €**

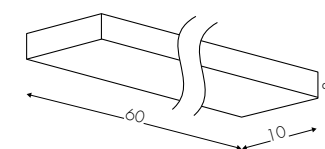

**2026FOFBVE28B** 35W 5000lm - 220V **368,00 €**  
**2026FDMBVE28B** DALI (Push) - 35W 5000lm - 220V **420,00 €**

Configura Configure / Konfigurieren

[www.teamitaliailluminazione.it](http://www.teamitaliailluminazione.it)

## SUPERFLUX

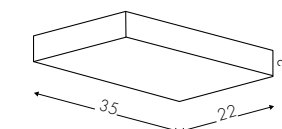

**2026MOFBVE28B** 60W 8200lm\* - 220V **336,00 €**  
**2026MDMBVE28B** DALI (Push) - 60W 8200lm - 220V **380,00 €**

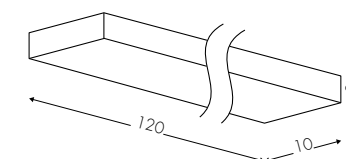

**2026NOFBVE28B** 70W 9200lm - 220V **585,00 €**  
**2026NDMBVE28B** DALI (Push) - 70W 9200lm - 220V **642,00 €**

Configura Configure / Konfigurieren

[www.teamitaliailluminazione.it](http://www.teamitaliailluminazione.it)



● A 2700K

NE RU

**TF** Taglio di Fase - Phase-Cut Dimmer - Phasenabschnittdimmer  
**A** Alimentatore Incorporato - Incorporated Power Supply - Eingebautes Netzteil

\* 1350lm effettivi - effective - effektive con - with - mit **E28**

**CODICE COMPLETO DEL PRODOTTO NELLA FOTO**  
**FULL PRODUCT CODE AS SHOWN IN PICTURE - VOLLSTÄNDIGER CODE VOM ARTIKEL IM BILD**

**2026FOF** **RU** **E28** **A**

Codice  
Code

Finitura  
Finishing  
Lackierung

Diffusore  
Diffuser  
Diffusor

Tonalità  
Hue  
Farbton





configurazione standard: / basic configuration: / Standard Konfiguration:

E28 Satinato  
Frosted - Satinert

● B 3000K

BV

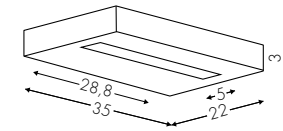

**2026OOFBVE28B**  
**2026ODMBVE28B**

50W 6500lm\* + 10W 1500lm - 220V  
DALI (Push) - 50W 6500lm + 10W 1500lm - 220V

**402,00 €**  
**446,00 €**

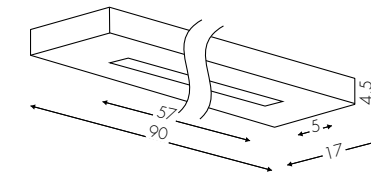

**2026QOFBVE28B**  
**2026QDMBVE28B**

50W 6500lm + 10W 1500lm - 220V  
DALI (Push) - 50W 6500lm + 10W 1500lm - 220V

**557,00 €**  
**611,00 €**

Configura

Configure / Konfigurieren

[www.teamitaliailluminazione.it](http://www.teamitaliailluminazione.it)



● A 2700K

NE RU

A Alimentatore Incorporato - Incorporated Power Supply - Eingebautes Netzteil

\* 6500lm effettivi - effective - effektive con - with - mit E28

**CODICE COMPLETO DEL PRODOTTO NELLA FOTO**  
FULL PRODUCT CODE AS SHOWN IN PICTURE - VOLLSTÄNDIGER CODE VOM ARTIKEL IM BILD

**2026QOF** **NE** **E28** **A**

Codice  
Code

Finitura  
Finishing  
Lackierung

Diffusore  
Diffuser  
Diffusor

Tonalità  
Hue  
Farbton



configurazione standard: / basic configuration: / Standard Konfiguration:

E28 Satinato  
Frosted - Satinert

● B 3000K

BV

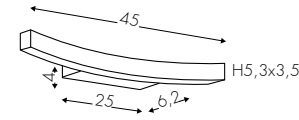

**2027AOFBVE28B**  
**2027ADMBVE28B**  
**2027ATFBVE28B**

15W 1600lm\* + 15W 1600lm - 220V  
DALI (Push) - 15W 1600lm + 15W 1600lm - 220V  
15W 1600lm + 15W 1600lm - 220V

**296,00 €**  
**369,00 €**  
**369,00 €**

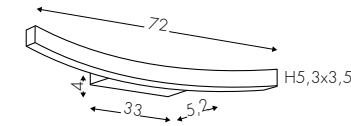

**2027BOFBVE28B**  
**2027BDMBVE28B**

20W 2125lm + 20W 2125lm - 220V  
DALI (Push) - 20W 2125lm + 20W 2125lm - 220V

**603,00 €**  
**701,00 €**

Configura

Configure / Konfigurieren

[www.teamitaliailluminazione.it](http://www.teamitaliailluminazione.it)



● A 2700K

NE RU

**CODICE COMPLETO DEL PRODOTTO NELLA FOTO**  
FULL PRODUCT CODE AS SHOWN IN PICTURE - VOLLSTÄNDIGER CODE VOM ARTIKEL IM BILD

**2027BOF** **RU** **E28** **A**

Codice  
Code

Finitura  
Finishing  
Lackierung

Diffusore  
Diffuser  
Diffusor

Tonalità  
Hue  
Farbton

**TF** Taglio di Fase - Phase-Cut Dimmer - Phasenabschnittdimmer

**A** Alimentatore Incorporato - Incorporated Power Supply - Eingebautes Netzteil

\* 1600lm effettivi - effective - effektive con - with - mit **E28**

# COMPACT

PARETE  
WALL LIGHT  
WANDLEUCHTE 

configurazione standard: / basic configuration: / Standard Konfiguration:

E2 Opale - Opal  B 3000K

BV

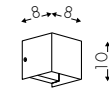

**D320BVE2B** 4W 350lm\* - 220V

**157,00 €**

[Configura](#)  Configure / Konfigurieren

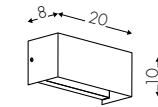

**D321BVE2B** 7W 1100lm - 220V

**195,00 €**

**D321TFBVE2B** 7W 1100lm - 220V

**224,00 €**

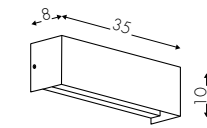

**D326BVE2B** 21W 2420lm - 220V

**280,00 €**

**D326DMBVE2B** DALI (Push) - 21W 2420lm - 220V

**344,00 €**

**D326TFBVE2B** 21W 2420lm - 220V

**344,00 €**

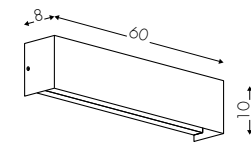

**D325BVE2B** 29W 3400lm - 220V

**374,00 €**

**D325DMBVE2B** DALI (Push) - 29W 3400lm - 220V

**439,00 €**

[Configura](#)  Configure / Konfigurieren

[www.teamitaliailluminazione.it](http://www.teamitaliailluminazione.it) 



 A 2700K

BV

 **CODICE COMPLETO DEL PRODOTTO NELLA FOTO**  
FULL PRODUCT CODE AS SHOWN IN PICTURE - VOLLSTÄNDIGER CODE VOM ARTIKEL IM BILD

**D321**

Codice  
Code

**BV**

Finitura  
Finishing  
Lackierung

**E2**

Diffusore  
Diffuser  
Diffusor

**A**

Tonalità  
Hue  
Farbton

**TF** Taglio di Fase - Phase-Cut Dimmer - Phasenabschrittdimmer

**A** Alimentatore Incorporato - Incorporated Power Supply - Eingebautes Netzteil

\* 350lm effettivi - effective - effektive con - with - mit **E2**





configurazione standard: / basic configuration: / Standard Konfiguration:

E2 Opale - Opal

● B 3000K

BV

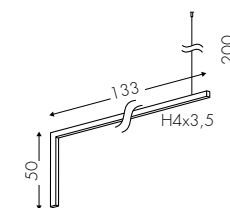

**2028GOFBVE2B**  
**2028GDMBVE2B**

34W 2490lm\* - 220V  
DALI (Push) - 34W 2490lm - 220V

**489,00 €**  
**528,00 €**

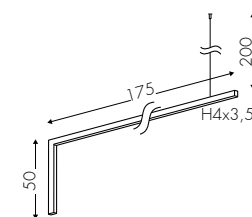

**2028EOFBVE2B**  
**2028EDMBVE2B**

51W 3740lm - 220V  
DALI (Push) - 51W 3740lm - 220V

**513,00 €**  
**577,00 €**

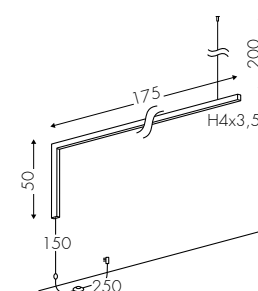

**2028FOFBVE2B**  
**2028FDMBVE2B**

51W 3740lm - 220V  
DALI (Push) - 51W 3740lm - 220V

**577,00 €**  
**651,00 €**

Configura

Configure / Konfigurieren

[www.teamitaliailluminazione.it](http://www.teamitaliailluminazione.it)



E19 Prismatico - Prism

● A 2700K

NE RU



A Alimentatore Incorporato - Incorporated Power Supply - Eingebautes Netzteil

\* 2490lm effettivi - effective - effektive con - with - mit **E2**  
2930lm effettivi - effective - effektive con - with - mit **E19** ↻ +17,5%

**CODICE COMPLETO DEL PRODOTTO NELLA FOTO**  
FULL PRODUCT CODE AS SHOWN IN PICTURE - VOLLSTÄNDIGER CODE VOM ARTIKEL IM BILD

**2028GOF** **NE** **E2** **B**

Codice  
Code

Finitura  
Finishing  
Lackierung

Diffusore  
Diffuser  
Diffusor

Tonalità  
Hue  
Farbton





configurazione standard: / basic configuration: / Standard Konfiguration:

E2 Opale - Opal

● B 3000K

BV

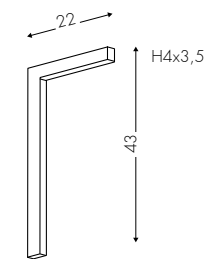

2028AOFBVE2B

9W 977lm\* - 220V

352,00 €

Configura Configure / Konfigurieren

[www.teamitaliailluminazione.it](http://www.teamitaliailluminazione.it)



E19 Prismatizzato - Prism

● A 2700K

NE RU

A Alimentatore Incorporato - Incorporated Power Supply - Eingebautes Netzteil

\* 977lm effettivi - effective - effektive con - with - mit E2  
1150lm effettivi - effective - effektive con - with - mit E19 ↻ +17,5%

CODICE COMPLETO DEL PRODOTTO NELLA FOTO  
FULL PRODUCT CODE AS SHOWN IN PICTURE - VOLLSTÄNDIGER CODE VOM ARTIKEL IM BILD

**2028AOF** **NE** **E2** **A**

Codice  
Code

Finitura  
Finishing  
Lackierung

Diffusore  
Diffuser  
Diffusor

Tonalità  
Hue  
Farbton





configurazione standard: / basic configuration: / Standard Konfiguration:

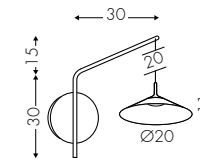

E19 Prismatico - Prism

B 3000K



2071ATFONE19B

6,5W 800lm\* - 220V

345,00 €

C005A2TR

Custom transparent cable

7,00 € /MT

Configura



Configure / Konfigurieren

[www.teamitaliailluminazione.it](http://www.teamitaliailluminazione.it)



A 2700K



**CODICE COMPLETO DEL PRODOTTO NELLA FOTO**  
FULL PRODUCT CODE AS SHOWN IN PICTURE - VOLLSTÄNDIGER CODE VOM ARTIKEL IM BILD

**2071ATF** **ON** **E19** **B**

Codice  
Code

Finitura  
Finishing  
Lackierung

Diffusore  
Diffuser  
Diffusor

Tonalità  
Hue  
Farbton

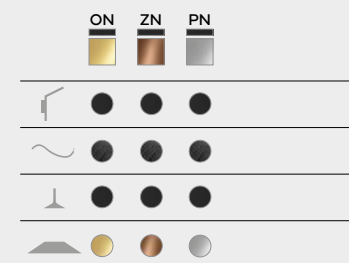

**A** Alimentatore Incorporato - Incorporated Power Supply - Eingebautes Netzteil

**TF** Taglio di Fase - Phase-Cut Dimmer - Phasenabschrittdimmer

\* 800lm effettivi - effective - effektiven con - with - mit **E19**



configurazione standard: / basic configuration: / Standard Konfiguration:

E19 Prismatico - Prism ● B 3000K



**5071ADPONE19B** 6,5W 800lm\* - 220V

**540,00 €**

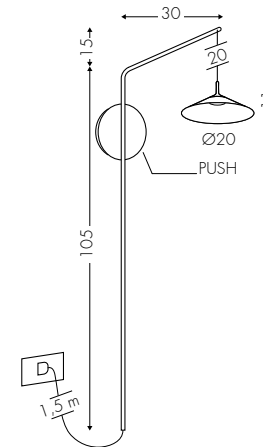

**C005A2TR** Custom transparent cable

**7,00 € /MT**

Configura Configure / Konfigurieren

[www.teamitaliailluminazione.it](http://www.teamitaliailluminazione.it)



● A 2700K



**CODICE COMPLETO DEL PRODOTTO NELLA FOTO**  
FULL PRODUCT CODE AS SHOWN IN PICTURE - VOLLSTÄNDIGER CODE VOM ARTIKEL IM BILD

**5071ADP PN E19 A**

Codice Code	Finitura Finishing Lackierung	Diffusore Diffuser Diffusor	Tonalità Hue Farbton
----------------	-------------------------------------	-----------------------------------	----------------------------

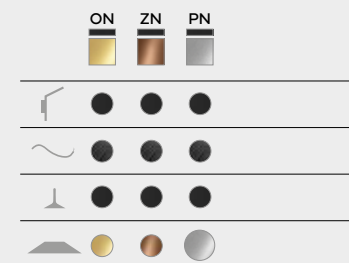

**A** Alimentatore Incorporato - Incorporated Power Supply - Eingebautes Netzteil  
**DP** Dimmerabile con pulsante - Dimmable with pushbutton - Dimmbare mit Touch-Button

\* 800lm effettivi - effective - effektiven con - with - mit **E19**

# LEGGERA

PARETE  
WALL LIGHT  
WANDLEUCHTE



configurazione standard: / basic configuration: / Standard Konfiguration:

E2 Opale - Opal

● B 3000K

BV

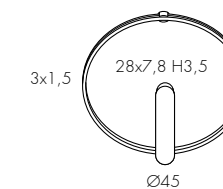

**2032COFBVE2B**  
**2032CDMBVE2B**  
**2032CTFBVE2B**

25W 1260lm\* - 220V  
DALI (Push) - 25W 1260lm - 220V  
25W 1260lm - 220V

**474,00 €**  
**553,00 €**  
**553,00 €**

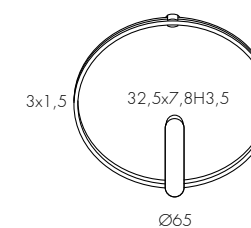

**2032AOFBVE2B**  
**2032ADMBVE2B**  
**2032ATFBVE2B**

35W 1740lm - 220V  
DALI (Push) - 35W 1740lm - 220V  
35W 1740lm - 220V

**601,00 €**  
**697,00 €**  
**697,00 €**

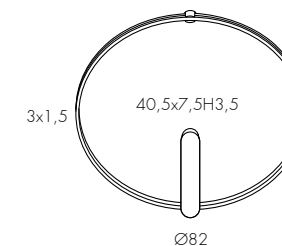

**2032BOFBVE2B**  
**2032BDMBVE2B**  
**2032BTFBVE2B**

48W 2580lm - 220V  
DALI (Push) - 48W 2580lm - 220V  
48W 2580lm - 220V

**709,00 €**  
**808,00 €**  
**808,00 €**

Configura

Configure / Konfigurieren

[www.teamitaliailluminazione.it](http://www.teamitaliailluminazione.it)



● A 2700K

NE RV BR OV

**TF** Taglio di Fase - Phase-Cut Dimmer - Phasenabschnittdimmer  
**A** Alimentatore Incorporato - Incorporated Power Supply - Eingebautes Netzteil

\* 1260lm effettivi - effective - effektive con - with - mit **E2**

**CODICE COMPLETO DEL PRODOTTO NELLA FOTO**  
FULL PRODUCT CODE AS SHOWN IN PICTURE - VOLLSTÄNDIGER CODE VOM ARTIKEL IM BILD

**2032BOF** **OV** **E2** **A**

Codice Code	Finitura Finishing Lackierung	Diffusore Diffuser Diffusor	Tonalità Hue Farbton
----------------	-------------------------------------	-----------------------------------	----------------------------

INDEX

SECTION

FAMILY 25



# LINEA DARK

PARETE  
WALL LIGHT  
WANDLEUCHTE



configurazione standard: / basic configuration: / Standard Konfiguration:

E2 Opale - Opal

B 3000K

BV

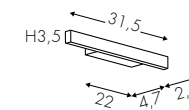

**2021AOFBVE2B**

10W 1250lm\* - 220V

**190,00 €**

**2021ATFBVE2B**

10W 1250lm - 220V

**219,00 €**

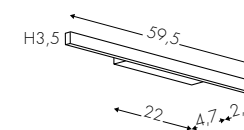

**2021BOFBVE2B**

20W 2200lm - 220V

**246,00 €**

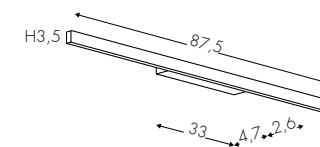

**2021COFBVE2B**

30W 3400lm - 220V

**347,00 €**

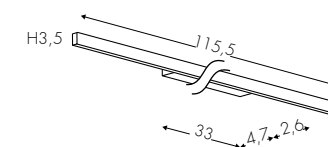

**2021DOFBVE2B**

38W 4400lm - 220V

**427,00 €**

Configura

Configure / Konfigurieren

[www.teamitaliailluminazione.it](http://www.teamitaliailluminazione.it)



A 2700K

NE RU

**CODICE COMPLETO DEL PRODOTTO NELLA FOTO**  
FULL PRODUCT CODE AS SHOWN IN PICTURE - VOLLSTÄNDIGER CODE VOM ARTIKEL IM BILD

**2021BOF** **NE** **E2** **A**

Codice  
Code

Finitura  
Finishing  
Lackierung

Diffusore  
Diffuser  
Diffusor

Tonalità  
Hue  
Farbton

**TF** Taglio di Fase - Phase-Cut Dimmer - Phasenabschnittdimmer

**A** Alimentatore Incorporato - Incorporated Power Supply - Eingebautes Netzteil

\* 1250lm effettivi - effective - effektive con - with - mit **E2**

INDEX

SECTION

FAMILY 27



configurazione standard: / basic configuration: / Standard Konfiguration:

GU10

BV

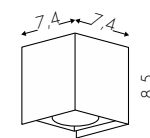

2009AOFBV

1x GU10 max 7W - 220V

89,00 €



Configura

Configure / Konfigurieren

[www.teamitaliailluminazione.it](http://www.teamitaliailluminazione.it)

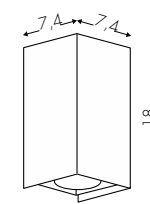

2009BOFBV

2x GU10 max 7W - 220V

165,00 €



Configura

Configure / Konfigurieren

[www.teamitaliailluminazione.it](http://www.teamitaliailluminazione.it)

NE RU

GU10 Sorgente GU10 non inclusa - GU10 light source not included - GU10 Lichtquelle nicht enthalten

CODICE COMPLETO DEL PRODOTTO NELLA FOTO  
FULL PRODUCT CODE AS SHOWN IN PICTURE - VOLLSTÄNDIGER CODE VOM ARTIKEL IM BILD

**2009BOF** **NE**

Codice  
Code

Finitura  
Finishing  
Lackierung





configurazione standard: / basic configuration: / Standard Konfiguration:

E2 Opale - Opal

 B 3000K

BV

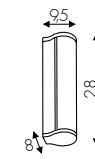

**2060ATFBVE2B**

7W 714lm\* - 220V

**188,00 €**



**2060BTFBVE2B**  
**2060BDMBVE2B**

13W 1428lm - 220V

DALI (Push) 13W 1428lm - 220V

**228,00 €**

**272,00 €**

Configura 

Configure / Konfigurieren

[www.teamitaliailluminazione.it](http://www.teamitaliailluminazione.it) 



 A 2700K   C 4000K

NE

 **CODICE COMPLETO DEL PRODOTTO NELLA FOTO**  
FULL PRODUCT CODE AS SHOWN IN PICTURE - VOLLSTÄNDIGER CODE VOM ARTIKEL IM BILD

**2060BTF** **NE** **E2** **C**

Codice  
Code

Finitura  
Finishing  
Lackierung

Diffusore  
Diffuser  
Diffusor

Tonalità  
Hue  
Farbton

**TF** Taglio di Fase - Phase-Cut Dimmer - Phasenabschnittdimmer

**A** Alimentatore Incorporato - Incorporated Power Supply - Eingebautes Netzteil

\* 714lm effettivi - effective - effektive con - with - mit **E2**



configurazione standard: / basic configuration: / Standard Konfiguration:

E28 Satinato  
Frosted - Satiniert

**B** 3000K

BV

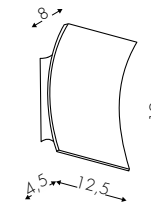

**2004EOFBVE28B** 4,5W 450lm\* + 4,5W 450lm - 220V **152,00 €**  
**2004ETFBVE28B** 4,5W 450lm + 4,5W 450lm - 220V **198,00 €**

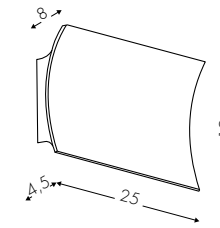

**2004DOFBVE28B** 10W 1300lm + 10W 1300lm - 220V **269,00 €**  
**2004DDMBVE28B** DALI (Push) - 10W 1300lm + 10W 1300lm - 220V **313,00 €**  
**2004DTFBVE28B** 10W 1300lm + 10W 1300lm - 220V **313,00 €**

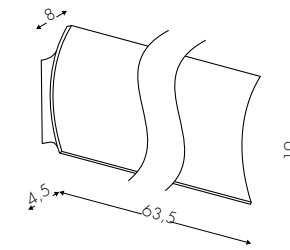

**2004COFBVE28B** 18W 1800lm + 18W 1800lm - 220V **477,00 €**  
**2004CDMBVE28B** DALI (Push) - 18W 1800lm + 18W 1800lm - 220V **593,00 €**  
**2004CTFBVE28B** 18W 1800lm + 18W 1800lm - 220V **593,00 €**

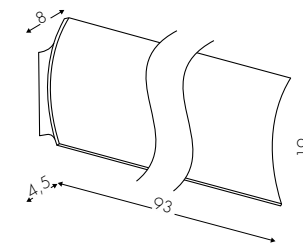

**2004AOFBVE28B** 26W 2700lm + 26W 2700lm - 220V **551,00 €**  
**2004ADMBVE28B** DALI (Push) - 26W 2700lm + 26W 2700lm - 220V **668,00 €**  
**2004AOFEMBVE28B** 26W 2700lm + 26W 2700lm - 220V **735,00 €**

Configura Configure / Konfigurieren

[www.teamitaliailluminazione.it](http://www.teamitaliailluminazione.it)



**A** 2700K

RU

**CODICE COMPLETO DEL PRODOTTO NELLA FOTO**  
**FULL PRODUCT CODE AS SHOWN IN PICTURE - VOLLSTÄNDIGER CODE VOM ARTIKEL IM BILD**

**2004DOF** **RU** **E28** **B**

Codice  
Code

Finitura  
Finishing  
Lackierung

Diffusore  
Diffuser  
Diffusor

Tonalità  
Hue  
Farbton

**EM** Emergenza - Emergency - Notbeleuchtung  
**TF** Taglio di Fase - Phase-Cut Dimmer - Phasenabschrittdimmer  
**A** Alimentatore Incorporato - Incorporated Power Supply - Eingebautes Netzteil

\* 450lm effettivi - effective - effektive con - with - mit **E28**



# OVERLAP DECÓ

PARETE  
WALL LIGHT  
WANDLEUCHTE



configurazione standard: / basic configuration: / Standard Konfiguration:

E2 Opale - Opal

 B 3000K

BV



2015ATFBVE2B

26W 2295lm\* + 13W 1150lm - 220V

460,00 €

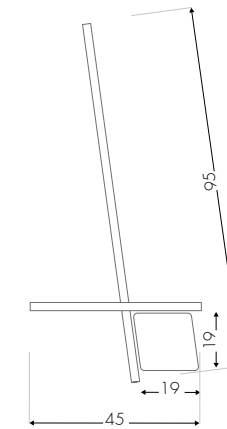
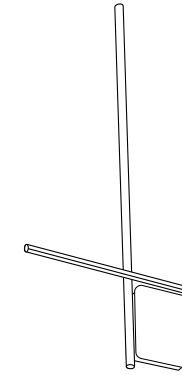

Configura 

Configure / Konfigurieren

[www.teamitaliailluminazione.it](http://www.teamitaliailluminazione.it) 



 A 2700K



 CODICE COMPLETO DEL PRODOTTO NELLA FOTO  
FULL PRODUCT CODE AS SHOWN IN PICTURE - VOLLSTÄNDIGER CODE VOM ARTIKEL IM BILD

**2015ATF** **OV** **E2** **B**

Codice  
Code

Finitura  
Finishing  
Lackierung

Diffusore  
Diffuser  
Diffusor

Tonalità  
Hue  
Farbton

 INDEX

 SECTION

 FAMILY

35



configurazione standard: / basic configuration: / Standard Konfiguration:

E2 Opale - Opal - Opal ● B 3000K

BV



**2052AOFBVE2B**  
**2052ATFBVE2B**

15W 1900lm\* - 220V  
15W 1900lm - 220V

**253,00 €**  
**266,00 €**

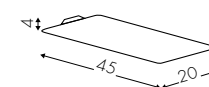

**2052COFBVE2B**  
**2052CDBVE2B**

23W 2800lm - 220V  
DALI (Push) - 23W 2800lm - 220V

**308,00 €**  
**329,00 €**



Configura Configure / Konfigurieren

[www.teamitaliailluminazione.it](http://www.teamitaliailluminazione.it)

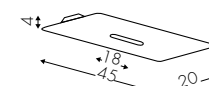

**2052DOFBVE2B**  
**2052DDMBVE2B**

23W 2800lm + 9W 800lm - 220V  
DALI (Push) - 23W 2800lm + 9W 800lm - 220V

**371,00 €**  
**420,00 €**



Configura Configure / Konfigurieren

[www.teamitaliailluminazione.it](http://www.teamitaliailluminazione.it)

● A 2700K

NE RV BR OV

**CODICE COMPLETO DEL PRODOTTO NELLA FOTO**  
FULL PRODUCT CODE AS SHOWN IN PICTURE - VOLLSTÄNDIGER CODE VOM ARTIKEL IM BILD

**2052AOF** **RV** **E2** **A**

Codice  
Code

Finitura  
Finishing  
Lackierung

Diffusore  
Diffuser  
Diffusor

Tonalità  
Hue  
Farbton

**TF** Taglio di Fase - Phase-Cut Dimmer - Phasenabschnittdimmer

**A** Alimentatore Incorporato - Incorporated Power Supply - Eingebautes Netzteil

\* 1900lm effettivi - effective - effektive con - with - mit **E2**

# SHADOW

PARETE  
WALL LIGHT  
WANDLEUCHTE



configurazione standard: / basic configuration: / Standard Konfiguration:

E2 Opale - Opal - Opal ● B 3000K

BV

**2068ATFBVE2B** 39W 2680lm\* - 220V **520,00 €**  
**2068ADMBVE2B** DALI (Push) - 39W 2680lm - 220V **595,00 €**

**2068BTFBVE2B** 49W 3440lm - 220V **695,00 €**  
**2068BDMBVE2B** DALI (Push) - 49W 3440lm - 220V **788,00 €**

**2068CTFBVE2B** 66W 5630lm - 220V **835,00 €**  
**2068CDMBVE2B** DALI (Push) - 66W 5630lm - 220V **935,00 €**

**VA004A** Variazione: sostituzione con rosone decentrato  
 Variation: substitution with decentralized ceiling rose  
 Variante: ersatz durch dezentral deckenrose **88,00 €**

**C005T2NE** Custom black cable **8,00 € /MT**

Configura Configure / Konfigurieren

[www.teamitaliailluminazione.it](http://www.teamitaliailluminazione.it)

● ● A

● A 2700K

NE RV BR OV

BV NE RV BR OV

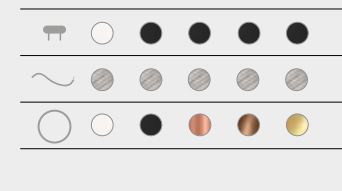

**A** Alimentatore nel rosone - Power Supply inside the ceiling rose - Netzteil in der Deckendose  
**TF** Taglio di Fase - Phase-Cut Dimmer - Phasenabschrittdimmer

\* 2680lm effettivi - effective - effektiven con - with - mit **E2**

INDEX

SECTION

FAMILY 39

**CODICE COMPLETO DEL PRODOTTO NELLA FOTO**  
 FULL PRODUCT CODE AS SHOWN IN PICTURE - VOLLSTÄNDIGER CODE VOM ARTIKEL IM BILD

**2068BTF** **OV** **E2** **A**

Codice Code  
 Finitura Finishing  
 Lackierung  
 Diffusore Diffuser  
 Diffusor  
 Tonalità Hue  
 Farbton

configurazione standard: / basic configuration: / Standard Konfiguration:

E19 UGR<19 - Prism ● B 3000K

BV

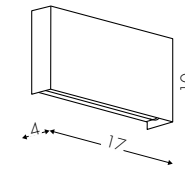

<b>2019EOFBVE19B</b>	14W 2100lm* - 220V	<b>181,00 €</b>
<b>2019EDMBVE19B</b>	DALI (Push) - 14W 2100lm - 220V	<b>229,00 €</b>
<b>2019ETFBVE19B</b>	14W 2100lm - 220V	<b>211,00 €</b>

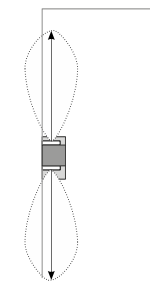

DISTRIBUZIONE  
LUMINOSA  
LIGHTING EMISSION  
LICHT EMISSION

Configura  Configure / Konfigurieren

[www.teamitaliailluminazione.it](http://www.teamitaliailluminazione.it) 



● A 2700K ○ C 4000K

NE RU  

**TF** Taglio di Fase - Phase-Cut Dimmer - Phasenabschnittdimmer

**A** Alimentatore Incorporato - Incorporated Power Supply - Eingebautes Netzteil

\* 2100lm effettivi - effective - effektive con - with - mit **E19**



OV custom finish

 **CODICE COMPLETO DEL PRODOTTO NELLA FOTO**  
FULL PRODUCT CODE AS SHOWN IN PICTURE - VOLLSTÄNDIGER CODE VOM ARTIKEL IM BILD

**2019EOF** | **OV** | **E19** | **B**

Codice  
Code

Finitura  
Finishing  
Lackierung

Diffusore  
Diffuser  
Diffusor

Tonalità  
Hue  
Farbton

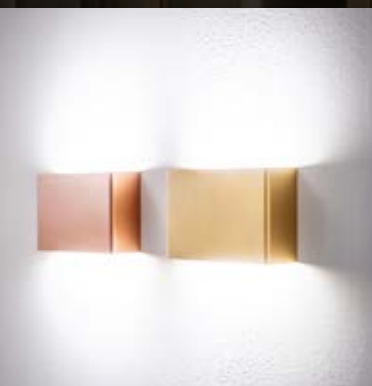



configurazione standard: / basic configuration: / Standard Konfiguration:

E19 UGR<19 - Prism

● B 3000K

BV

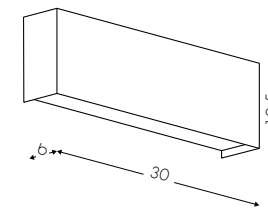

<b>2019AOFBVE19B</b>	21W 2700lm* - 220V	<b>240,00 €</b>
<b>2019ADMBVE19B</b>	DALI (Push) - 21W 2700lm - 220V	<b>303,00 €</b>
<b>2019ATFBVE19B</b>	21W 2700lm - 220V	<b>277,00 €</b>

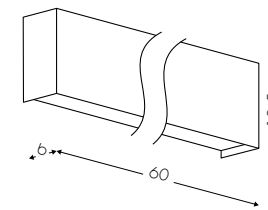

<b>2019BOFBVE19B</b>	42W 5300lm - 220V	<b>387,00 €</b>
<b>2019BDMBVE19B</b>	DALI (Push) - 42W 5300lm - 220V	<b>466,00 €</b>
<b>2019BTFBVE19B</b>	42W 5300lm - 220V	<b>466,00 €</b>

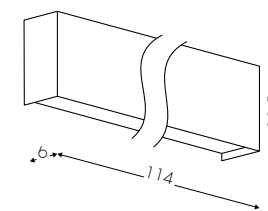

<b>2019COFBVE19B</b>	84W 10800lm - 220V	<b>674,00 €</b>
<b>2019CDMBVE19B</b>	DALI (Push) - 84W 10800lm - 220V	<b>738,00 €</b>

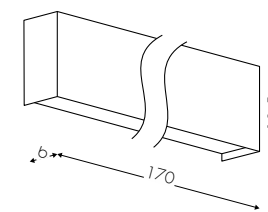

<b>2019DOFBVE19B</b>	126W 16000lm - 220V	<b>1.022,00 €</b>
<b>2019DDMBVE19B</b>	DALI (Push) - 126W 16000lm - 220V	<b>1.143,00 €</b>

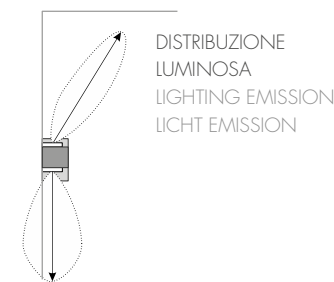

Configura 

Configure / Konfigurieren

[www.teamitaliailluminazione.it](http://www.teamitaliailluminazione.it) 



● A 2700K ○ C 4000K

NE RU  

 **CODICE COMPLETO DEL PRODOTTO NELLA FOTO**  
FULL PRODUCT CODE AS SHOWN IN PICTURE - VOLLSTÄNDIGER CODE VOM ARTIKEL IM BILD

**2019AOF** | **RU** | **E19** | **B**

Codice  
Code

Finitura  
Finishing  
Lackierung

Diffusore  
Diffuser  
Diffusor

Tonalità  
Hue  
Farbton

**TF** Taglio di Fase - Phase-Cut Dimmer - Phasenabschnittdimmer

**A** Alimentatore Incorporato - Incorporated Power Supply - Eingebautes Netzteil

\* 2700lm effettivi - effective - effektive con - with - mit **E19**

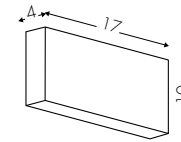

configurazione standard: / basic configuration: / Standard Konfiguration:

E19 UGR<19 - Prism ● B 3000K

BV

<b>2019EOFUPBVE19B</b>	7W 1100lm* - 220V	<b>181,00 €</b>
<b>2019EDMUPBVE19B</b>	DALI (Push) 7W 1100lm - 220V	<b>229,00 €</b>
<b>2019ETFUPBVE19B</b>	7W 1100lm - 220V	<b>211,00 €</b>

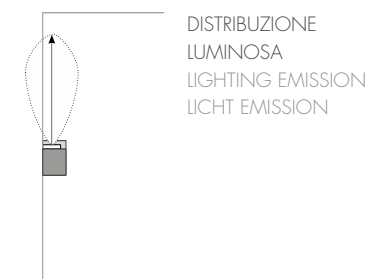

DISTRIBUZIONE  
LUMINOSA  
LIGHTING EMISSION  
LICHT EMISSION

Configura Configure / Konfigurieren

[www.teamitaliailluminazione.it](http://www.teamitaliailluminazione.it)



● A 2700K ○ C 4000K

NE RU

**CODICE COMPLETO DEL PRODOTTO NELLA FOTO**  
FULL PRODUCT CODE AS SHOWN IN PICTURE - VOLLSTÄNDIGER CODE VOM ARTIKEL IM BILD

**2019EOFUP** **NE** **E19** **B**

Codice Code	Finitura Finishing Lackierung	Diffusore Diffuser Diffusor	Tonalità Hue Farbton
----------------	-------------------------------------	-----------------------------------	----------------------------

**TF** Taglio di Fase - Phase-Cut Dimmer - Phasenabschnittdimmer  
**A** Alimentatore Incorporato - Incorporated Power Supply - Eingebautes Netzteil

\* 1100lm effettivi - effective - effektive con - with - mit **E19**



configurazione standard: / basic configuration: / Standard Konfiguration:

E19 UGR<19 Prism

● B 3000K

BV

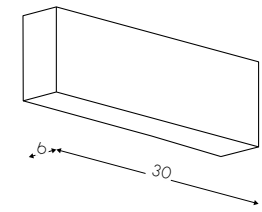

<b>2019AOFUPBVE19B</b>	21W 2700lm* - 220V	<b>240,00 €</b>
<b>2019ADMUPBVE19B</b>	DALI (Push) 21W 2700lm - 220V	<b>303,00 €</b>
<b>2019ATFUPBVE19B</b>	21W 2700lm - 220V	<b>277,00 €</b>

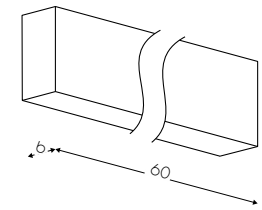

<b>2019BOFUPBVE19B</b>	42W 5300lm - 220V	<b>387,00 €</b>
<b>2019BDMUPBVE19B</b>	DALI (Push) 42W 5300lm - 220V	<b>466,00 €</b>
<b>2019BTFUPBVE19B</b>	42W 5300lm - 220V	<b>466,00 €</b>

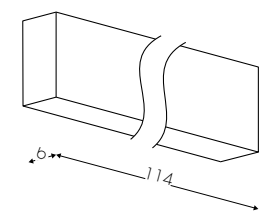

<b>2019COFUPBVE19B</b>	84W 10800lm - 220V	<b>674,00 €</b>
<b>2019CDMUPBVE19B</b>	DALI (Push) 84W 10800lm - 220V	<b>738,00 €</b>
<b>2019COFUPEMBVB</b>	84W 10800lm - 220V	<b>913,00 €</b>

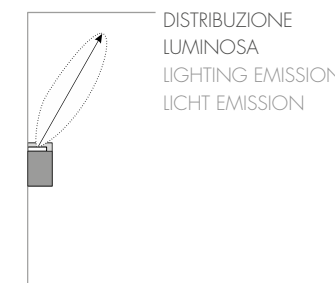

Configura Configure / Konfigurieren

[www.teamitaliailluminazione.it](http://www.teamitaliailluminazione.it)



● A 2700K ○ C 4000K

NE RU

**CODICE COMPLETO DEL PRODOTTO NELLA FOTO**  
FULL PRODUCT CODE AS SHOWN IN PICTURE - VOLLSTÄNDIGER CODE VOM ARTIKEL IM BILD

**2019BOFUP** **NE** **E19** **B**

Codice Code	Finitura Finishing Lackierung	Diffusore Diffuser Diffusor	Tonalità Hue Farbton
----------------	-------------------------------------	-----------------------------------	----------------------------

**EM** Emergenza - Emergency - Notbeleuchtung  
**TF** Taglio di Fase - Phase-Cut Dimmer - Phasenabschnittdimmer  
**A** Alimentatore Incorporato - Incorporated Power Supply - Eingebautes Netzteil

\* 2700lm effettivi - effective - effektive con - with - mit **E19**





configurazione standard: / basic configuration: / Standard Konfiguration:

BV

E2 Opale - Opal ● B 3000K

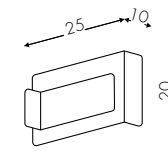

<b>D7000FBVE2B</b>	13W 1800lm* - 220V	<b>270,00 €</b>
<b>D700TFBVE2B</b>	13W 1800lm - 220V	<b>315,00 €</b>

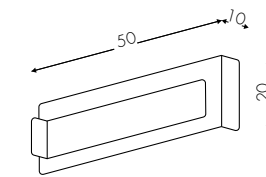

<b>D7020FBVE2B</b>	21W 2800lm - 220V	<b>380,00 €</b>
<b>D7020DMBVE2B</b>	DALI (Push) - 21W 2800lm - 220V	<b>455,00 €</b>

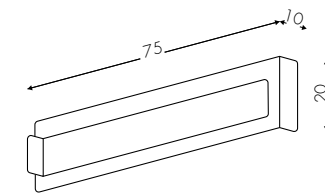

<b>D7030FBVE2B</b>	29W 4000lm - 220V	<b>551,00 €</b>
<b>D7030DMBVE2B</b>	DALI (Push) - 29W 4000lm - 220V	<b>618,00 €</b>

Configura Configure / Konfigurieren

[www.teamitaliailluminazione.it](http://www.teamitaliailluminazione.it)



● A 2700K



**CODICE COMPLETO DEL PRODOTTO NELLA FOTO**  
FULL PRODUCT CODE AS SHOWN IN PICTURE - VOLLSTÄNDIGER CODE VOM ARTIKEL IM BILD

**D7000F** **ON** **E2** **A**

Codice Code	Finitura Finishing Lackierung	Diffusore Diffuser Diffusor	Tonalità Hue Farbton
----------------	-------------------------------------	-----------------------------------	----------------------------

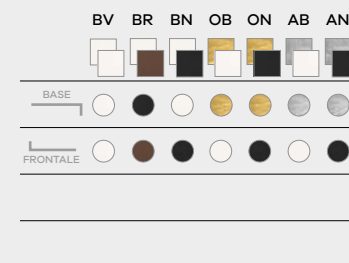

**TF** Taglio di Fase - Phase-Cut Dimmer - Phasenabschnittdimmer  
**A** Alimentatore Incorporato - Incorporated Power Supply - Eingebautes Netzteil

\* 1800lm effettivi - effective - effektive con - with - mit **E2**





configurazione standard: / basic configuration: / Standard Konfiguration:

**E28** Satinato  
Frosted - Satinert

**B** 3000K

BV

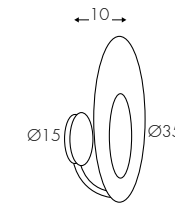

**2038AOFBVE28B**

15W 1900lm\* - 220V

**407,00 €**

**2038ADMBVE28B**

DALI (Push) - 15W 1900lm - 220V

**478,00 €**

**2038ATFBVE28B**

15W 1900lm - 220V

**478,00 €**

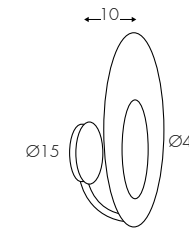

**2038BOFBVE28B**

18W 2600lm - 220V

**464,00 €**

**2038BDMBVE28B**

DALI (Push) - 18W 2600lm - 220V

**531,00 €**

**2038BTFBVE28B**

18W 2600lm - 220V

**531,00 €**

Configura

Configure / Konfigurieren

[www.teamitaliailluminazione.it](http://www.teamitaliailluminazione.it)



**A** 2700K

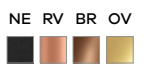

**CODICE COMPLETO DEL PRODOTTO NELLA FOTO**  
FULL PRODUCT CODE AS SHOWN IN PICTURE - VOLLSTÄNDIGER CODE VOM ARTIKEL IM BILD

**2038AOF** **BV** **E28** **B**

Codice  
Code

Finitura  
Finishing  
Lackierung

Diffusore  
Diffuser  
Diffusor

Tonalità  
Hue  
Farbton

**TF** Taglio di Fase - Phase-Cut Dimmer - Phasenabschrittdimmer

**A** Alimentatore Incorporato - Incorporated Power Supply - Eingebautes Netzteil

\* 1900lm effettivi - effective - effektive con - with - mit **E28**

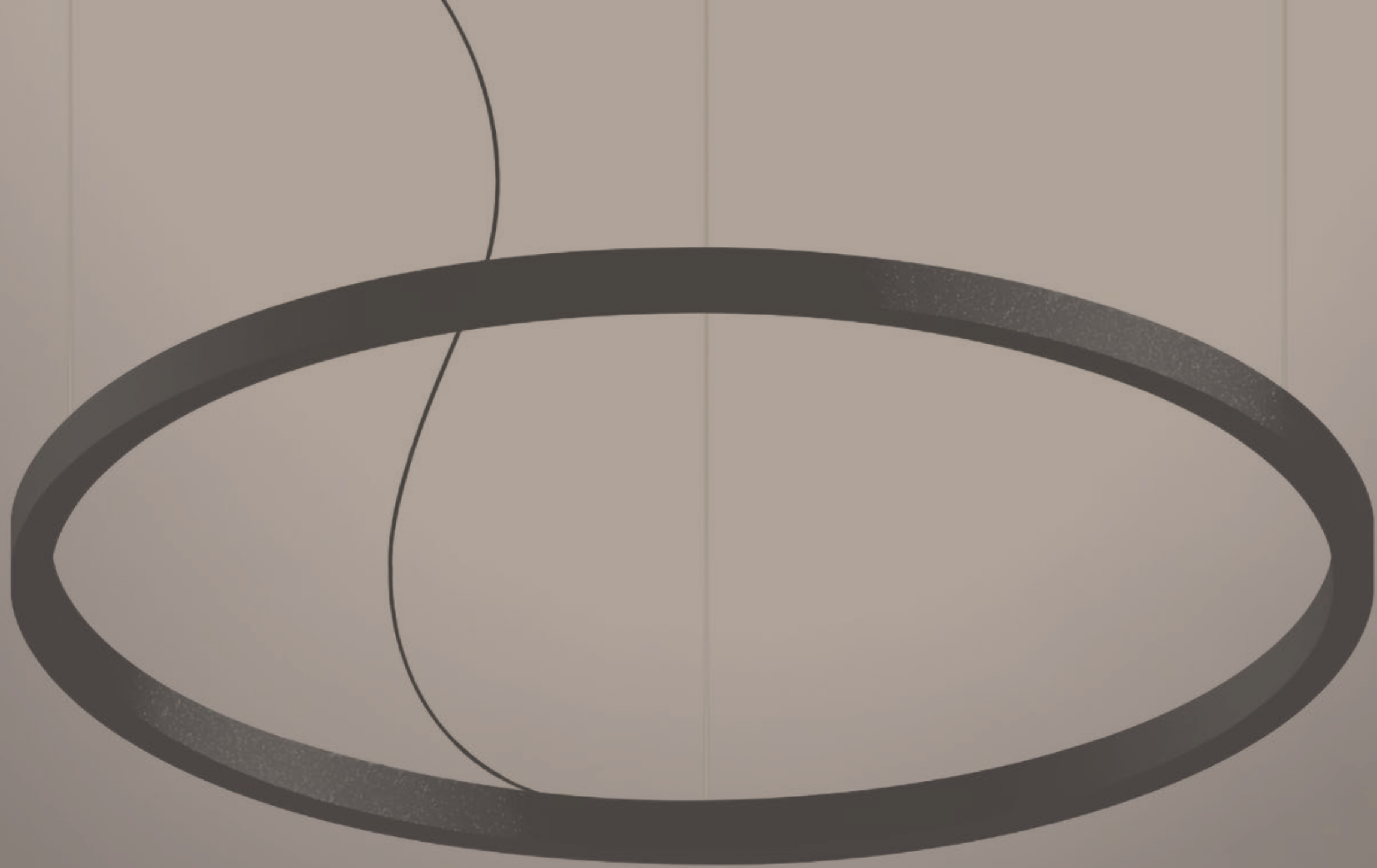

SOSPENSIONE  
SUSPENSION LAMP  
PENDELLEUCHE





**Bellai** 61  
up+downlight Ø70/Ø95/Ø130



**Bellai** 63  
up+downlight Ø180



**Bellai** 63  
up+downlight Ø260



**Bellai Home** 65-67  
up+downlight Ø58/Ø70/Ø95/Ø130/Ø180



**Curve** 79  
downlight L130/L165/L270



**Emme24** 93  
downlight 92x345



**Emme24** 93  
downlight 260x260



**Kasaa** 95  
downlight Ø40/Ø55 versione singola

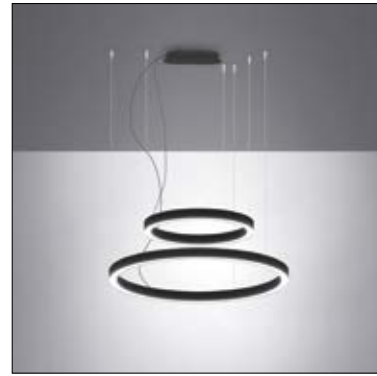

**Bellai Home** 69  
up+downlight composizione  
Ø58+Ø70 / Ø58+Ø95



**Bellai Up** 71  
uplight Ø130/Ø185



**Bulbe** 73  
downlight Ø15/Ø20 versione singola



**Bulbe** 75  
downlight Ø15/Ø20 composizione circolare



**Lambda** 97  
downlight Ø20/Ø30 versione singola



**Lambda** 99  
downlight Ø20/Ø30  
versione singola decentrata



**Lambda** 99  
downlight Ø20/Ø30  
composizione decentrata 2x



**Lambda** 101  
downlight Ø20 composizione lineare 3x



**Chapeau** 77  
downlight Ø42



**Chapeau** 77  
downlight Ø60

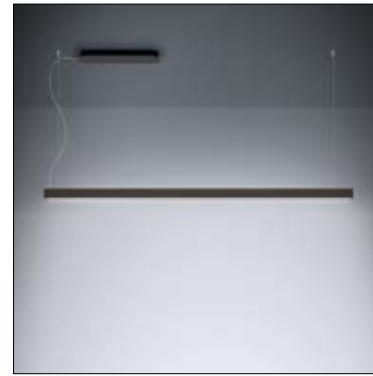

**Edge** 81  
downlight L116/L144/L242/L285



**Edge** 83  
downlight L59x59/L87x87/L115x115



**Lambda** 101  
downlight Ø20 composizione lineare 4x



**Lambda** 103  
downlight Ø20 composizione circolare 3x



**Lambda** 103  
downlight Ø20 composizione circolare 6x



**Edge** 85  
downlight L115x31/L143x59/L227x87



**Edge** 87  
uplight L59x59/L87x87



**Edge** 87  
uplight L143x59



**Edge** 89-91  
up+downlight composizione  
L145x59/L170x103/L227x131



**Leggera** 105  
downlight Ø65/Ø82/Ø110/Ø160



**Leggera** 107  
downlight Ø65+Ø82



**Leggera** 107  
downlight Ø65+Ø82+Ø110





**Mellow** 121  
downlight Ø15 H28 versione singola



**Mellow** 121  
downlight Ø15 H28 composizione 3x



**Mellow** 121  
downlight Ø15 H28 composizione 6x



**Sampling** 147  
Venis Lambda & Licis



**Ogis** 125  
downlight Ø13,5 H15 versione singola



**Ogis** 125  
downlight Ø13,5 H15 composizione 4x



**Ogis** 125  
downlight Ø13,5 H15 composizione 6x



**Licis** 109  
downlight Ø20 versione singola



**Licis** 109  
downlight Ø20 composizione decentrata 1x



**Licis** 111  
downlight Ø20 composizione decentrata 2x



**Licis** 111  
downlight Ø20 composizione decentrata 3x



**Oki** 127  
downlight 8x8 13W



**Oki** 127  
2x downlight 8x8 13W



**Omnia** 129  
downlight L112/L168/L225



**Omnia** 131  
downlight tunable white L112/L225



**Licis** 113  
downlight Ø20 composizione lineare 3x



**Licis** 113  
downlight Ø20 composizione lineare 4x



**Licis** 115  
downlight Ø20 composizione circolare 3x



**Licis** 115  
downlight Ø20 composizione circolare 6x



**Overlap 2.0** 135  
orientabile L120/L153/L250



**Overlap Decò** 137  
up+downlight 75x133



**Overlap Decò** 137  
up+downlight 94,5x94,5



**Overlap Decò** 137  
up+downlight 87x184



**Lieve** 117  
downlight L95/L125/L155



**Linea Dark** 119  
up+downlight L95/L120/L150



**Mirò Home** 123  
up + down + spotlight



**Riflessa** 141  
uplight L124/L208/L292



**Riflessa** 143  
uplight + darklight L124/L208/L292



**Riflessa** 145  
uplight + spotlight L124/L208/L292



**Pleni** 139  
downlight Ø38/Ø58/Ø88



**Shadow** 149  
orizzontale Ø70/Ø95/Ø130



**Shadow** 151  
composizione Ø70+Ø95/Ø95+Ø130



**Shape** 153  
up+downlight L55x55/L85x85/L130x130

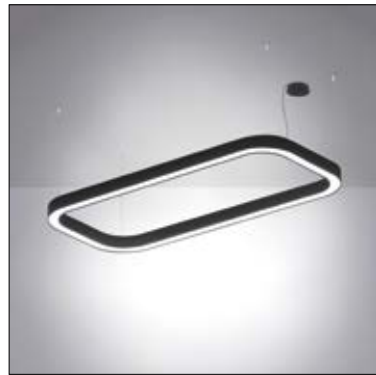

**Shape** 155  
up+downlight L183x85



**S-Pot Home** 157  
downlight Ø5,4 L15/L30 - GU10



**S-Pot Home** 157  
downlight Ø5,4 L60 - GU10



**S-Pot** 159  
downlight Ø11 L12-17W/L22-26W



**Tubico** 161  
downlight versione singola



**Tubico** 163  
downlight versione singola decentrata



**Tubico** 163  
downlight composizione decentrata 2x



**Tubico** 163  
downlight composizione decentrata 3x



**Velata** 169  
uplight Ø58/Ø73/Ø95



**Tubico** 165  
downlight composizione lineare 3x



**Tubico** 165  
downlight composizione lineare 5x



**Tubico** 165  
downlight composizione lineare 6x



**Venis** 171  
downlight Ø20 versione singola



**Venis** 173  
downlight Ø20 composizione decentrata 1x



**Venis** 173  
downlight Ø20 composizione decentrata 2x



**Venis** 173  
downlight Ø20 composizione decentrata 3x



**Tubico** 167  
downlight composizione circolare 4x



**Tubico** 167  
downlight composizione circolare 6x



**Tubico** 167  
downlight composizione circolare 12x



**Venis** 175  
downlight Ø20 composizione lineare 3x



**Venis** 175  
downlight Ø20 composizione lineare 4x



**Venis** 177  
downlight Ø20 composizione circolare 3x



**Venis** 177  
downlight Ø20 composizione circolare 6x





configurazione standard: / basic configuration: / Standard Konfiguration:

E2 Opal

● B 3000K

BV

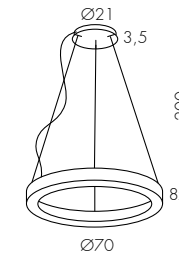

**1025AOFBVE2B**

50W 3810lm\* + 14W 2400lm - 220V

**1.025,00 €**

**1025ADMBVE2B**

DALI (Push) - 50W 3810lm + 14W 2400lm - 220V

**1.154,00 €**

**1025AOFEMBVE2B**

50W 3810lm + 14W 2400lm - 220V

**1.215,00 €**

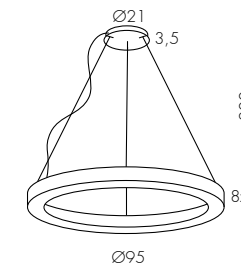

**1025BOFBVE2B**

65W 5170lm + 14W 2400lm - 220V

**1.409,00 €**

**1025BDMBVE2B**

DALI (Push) - 65W 5170lm + 14W 2400lm - 220V

**1.568,00 €**

**1025BOFEMBVE2B**

65W 5170lm + 14W 2400lm - 220V

**1.596,00 €**

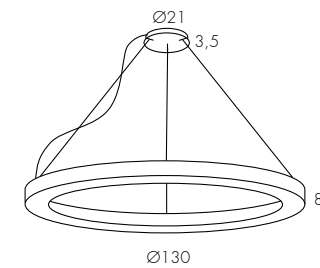

**1025COFBVE2B**

92W 7350lm + 24W 3600lm - 220V

**2.130,00 €**

**1025CDMBVE2B**

DALI (Push) - 92W 7350lm + 24W 3600lm - 220V

**2.325,00 €**

**1025CBTBVE2B**

Bluetooth 92W 7350lm + 24W 3600lm - 220V

**2.468,00 €**

**1025COFEMBVE2B**

92W 7350lm + 24W 3600lm - 220V

**2.314,00 €**

Configura

Configure / Konfigurieren

[www.teamitaliailluminazione.it](http://www.teamitaliailluminazione.it)



E19 UGR<19 Prism

● A 2700K ○ C 4000K

NE RU

**CODICE COMPLETO DEL PRODOTTO NELLA FOTO**  
FULL PRODUCT CODE AS SHOWN IN PICTURE - VOLLSTÄNDIGER CODE VOM ARTIKEL IM BILD

**1025BOF**

Codice Code

**BV**

Finitura Finishing  
Lackierung

**E19**

Diffusore Diffuser  
Diffusor

**B**

Tonalità Hue  
Farbton

BV NE RU



**EM** Emergenza - Emergency - Notbeleuchtung

**BT** Bluetooth - Bluetooth - Bluetooth

**A** Alimentatore Incorporato - Incorporated Power Supply - Eingebautes Netzteil

\* 3810lm effettivi - effective - effektive con - with - mit **E2**  
4480lm effettivi - effective - effektive con - with - mit **E19** ↻ +17,5%

INDEX

SECTION

FAMILY





configurazione standard: / basic configuration: / Standard Konfiguration:

E2 Opale - Opal

B 3000K

BV

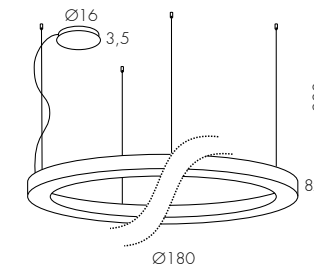

**1025DOFBVE2B**

160W 12950lm\* + 52W 7200lm - 220V

**3.009,00 €**

**1025DDMBVE2B**

DALI (Push) - 160W 12950lm + 52W 7200lm - 220V

**3.219,00 €**

**1025DOFEMBVE2B**

160W 12950lm + 52W 7200lm - 220V

**3.194,00 €**

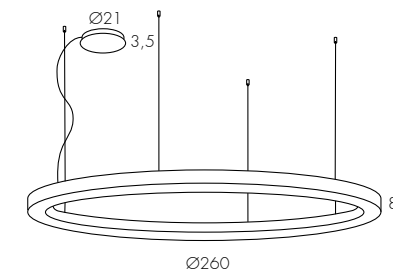

**1025EOFBVE2B**

250W 24000lm + 70W 9600lm - 220V

**4.625,00 €**

**1025EDMBVE2B**

DALI (Push) - 250W 24000lm + 70W 9600lm - 220V

**5.124,00 €**

**1025EOFEMBVE2B**

250W 24000lm + 70W 9600lm - 220V

**4.809,00 €**

Configura

Configure / Konfigurieren

[www.teamitaliailluminazione.it](http://www.teamitaliailluminazione.it)



E19 UGR<19 Prism

A 2700K  C 4000K

NE RU

**CODICE COMPLETO DEL PRODOTTO NELLA FOTO**  
FULL PRODUCT CODE AS SHOWN IN PICTURE - VOLLSTÄNDIGER CODE VOM ARTIKEL IM BILD

**1025DOF**

**BV**

**E2**

**A**

Codice  
Code

Finitura  
Finishing  
Lackierung

Diffusore  
Diffuser  
Diffusor

Tonalità  
Hue  
Farbton

BV NE RU

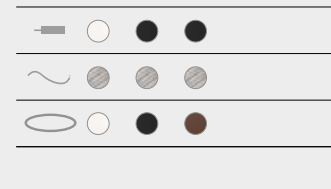

**EM** Emergenza - Emergency - Notbeleuchtung

**A** Alimentatore Incorporato - Incorporated Power Supply - Eingebautes Netzteil

\* 12950lm effettivi - effective - effektive con - with - mit **E2**

15200lm effettivi - effective - effektive con - with - mit **E19** **+17,5%**



configurazione standard: / basic configuration: / Standard Konfiguration:

E2 Opale - Opal

● B 3000K

BV

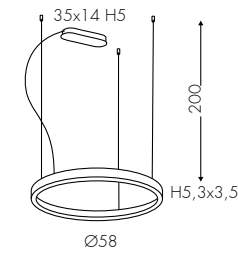

**1027EOF**BVE2B  
**1027EDM**BVE2B  
**1027ETF**BVE2B

42W 3247lm\* + 24W 2400lm - 220V  
DALI (Push) - 42W 3247lm + 24W 2400lm - 220V  
42W 3247lm + 24W 2400lm - 220V

**712,00 €**  
**821,00 €**  
**821,00 €**

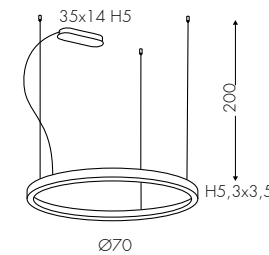

**1027AOF**BVE2B  
**1027ADM**BVE2B  
**1027ABT**BVE2B

50W 3808lm + 24W 2400lm - 220V  
DALI (Push) - 50W 3808lm + 24W 2400lm - 220V  
Bluetooth 50W 3808lm + 24W 2400lm - 220V

**849,00 €**  
**940,00 €**  
**940,00 €**

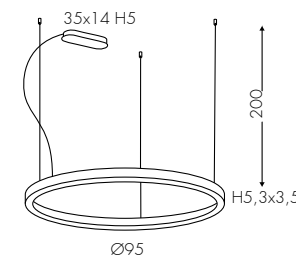

**1027BOF**BVE2B  
**1027BDM**BVE2B  
**1027BBT**BVE2B

65W 5168lm + 24W 2400lm - 220V  
DALI (Push) - 65W 5168lm + 24W 2400lm - 220V  
Bluetooth 65W 5168lm + 24W 2400lm - 220V

**1.091,00 €**  
**1.213,00 €**  
**1.213,00 €**

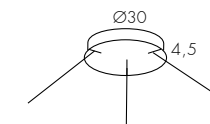

**VA003E**

Variazione: sostituzione con rosone centrale Ø30cm  
Variation: substitution with central ceiling rose Ø30cm  
Variante: Ersatz durch zentrale Deckenrose Ø30cm

**+100,00 €**

Configura

Configure / Konfigurieren

[www.teamitaliailluminazione.it](http://www.teamitaliailluminazione.it)



A

E19 UGR<19 Prism

● A 2700K

NE RU



BV NE RU

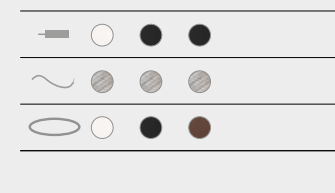

**TF** Taglio di Fase - Phase-Cut Dimmer - Phasenabschnittdimmer

**A** Alimentatore nel rosone - Power Supply inside the ceiling rose - Netzteil in der Deckendose

**BT** Bluetooth - Bluetooth - Bluetooth

\* 3247lm effettivi - effective - effektive con - with - mit **E2**  
3820lm effettivi - effective - effektive con - with - mit **E19** ↻ +17,5%

INDEX

SECTION

FAMILY

65



BR custom finish

**CODICE COMPLETO DEL PRODOTTO NELLA FOTO**  
FULL PRODUCT CODE AS SHOWN IN PICTURE - VOLLSTÄNDIGER CODE VOM ARTIKEL IM BILD

**1027EOF** **BR** **E2** **B**

Codice  
Code

Finitura  
Finishing  
Lackierung

Diffusore  
Diffuser  
Diffusor

Tonalità  
Hue  
Farbton







configurazione standard: / basic configuration: / Standard Konfiguration:

E2 Opale - Opal

B 3000K

BV

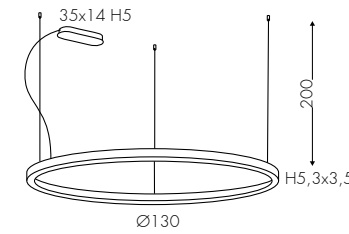

**1027COFBVE2B**  
**1027CDMBVE2B**  
**1027CBTBVE2B**

92W 7352lm\* + 29W 3600lm - 220V  
DALI (Push) - 92W 7352lm + 29W 3600lm - 220V  
Bluetooth 92W 7352lm + 29W 3600lm - 220V

**1.697,00 €**  
**1.839,00 €**  
**1.839,00 €**

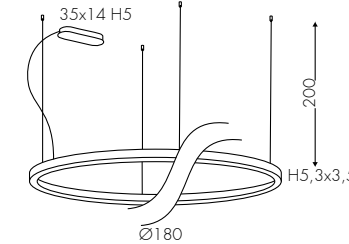

**1027DOFBVE2B**  
**1027DDMBVE2B**

110W 8755lm + 35W 5250lm - 220V  
DALI (Push) - 110W 8755lm + 35W 5250lm - 220V

**2.329,00 €**  
**2.592,00 €**

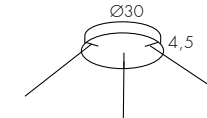

**VA003E**

Variation: sostituzione con rosone centrale Ø30cm  
Variation: substitution with central ceiling rose Ø30cm  
Variante: Ersatz durch zentrale Deckenrose Ø30cm

**100,00 €**

Configura

Configure / Konfigurieren

[www.teamitaliailluminazione.it](http://www.teamitaliailluminazione.it)



A

E19 UGR<19 Prism

A 2700K

NE RU

**CODICE COMPLETO DEL PRODOTTO NELLA FOTO**  
FULL PRODUCT CODE AS SHOWN IN PICTURE - VOLLSTÄNDIGER CODE VOM ARTIKEL IM BILD

**1027COF** **BV** **E2** **B**

Codice  
Code

Finitura  
Finishing  
Lackierung

Diffusore  
Diffuser  
Diffusor

Tonalità  
Hue  
Farbton

BV NE RU

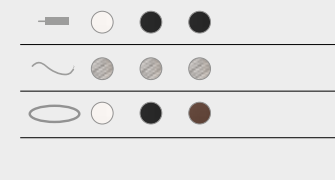

**A** Alimentatore nel rosone - Power Supply inside the ceiling rose - Netzteil in der Deckendose

**BT** Bluetooth - Bluetooth - Bluetooth

\* 7352lm effettivi - effective - effektive con - with - mit **E2**  
8650lm effettivi - effective - effektive con - with - mit **E19** **+17,5%**



configurazione standard: / basic configuration: / Standard Konfiguration:

E2 Opale - Opal

● B 3000K

BV

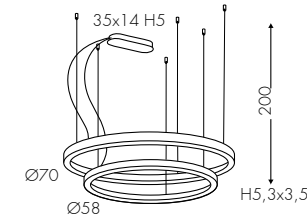

**1027AEOFBVE2B**

92W 7055lm\* + 48W 4800lm - 220V

**1.625,00 €**

**1027AEDMBVE2B**

DALI (Push) - 92W 7055lm + 48W 4800lm - 220V

**1.830,00 €**

**1027AEBTBVE2B**

Bluetooth 92W 7055lm + 48W 4800lm - 220V

**1.830,00 €**

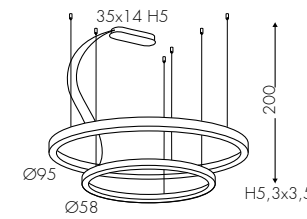

**1027BEOFBVE2B**

115W 9350lm + 48W 4800lm - 220V

**1.908,00 €**

**1027BEDMBVE2B**

DALI (Push) - 115W 9350lm + 48W 4800lm - 220V

**2.088,00 €**

**1027BEBTBVE2B**

Bluetooth 115W 9350lm + 48W 4800lm - 220V

**2.228,00 €**

Configura

Configure / Konfigurieren

[www.teamitaliailluminazione.it](http://www.teamitaliailluminazione.it)



A

E19 UGR<19 Prism

● A 2700K

NE RU

**CODICE COMPLETO DEL PRODOTTO NELLA FOTO**  
FULL PRODUCT CODE AS SHOWN IN PICTURE - VOLLSTÄNDIGER CODE VOM ARTIKEL IM BILD

**1027BEOF** **OV** **E2** **B**

Codice  
Code

Finitura  
Finishing  
Lackierung

Diffusore  
Diffuser  
Diffusor

Tonalità  
Hue  
Farbton

BV NE RU

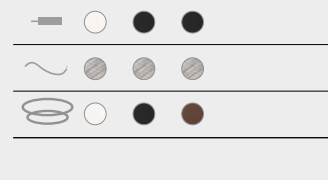

**A** Alimentatore nel rosone - Power Supply inside the ceiling rose - Netzteil in der Deckendose

**BT** Bluetooth - Bluetooth - Bluetooth

\* 7055lm effettivi - effective - effektive con - with - mit **E2**  
8300lm effettivi - effective - effektive con - with - mit **E19** ↻ +17,5%

# BELLAI UP

SOSPENSIONE  
SUSPENSION LAMP  
PENDELLEUCHE



configurazione standard: / basic configuration: / Standard Konfiguration:

**E28** Satinato  
Frosted - Satiniert

**B** 3000K

BV

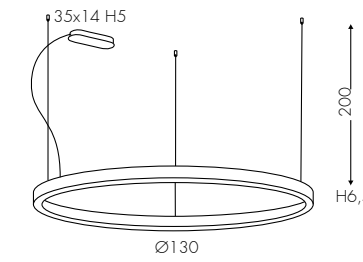

**1040COFBVE28B**  
**1040CDMBVE28B**

115W 13000lm\* - 220V  
DALI (Push) - 115W 13000lm - 220V

**2.094,00 €**  
**2.277,00 €**

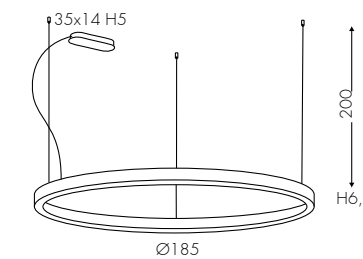

**1040DOFBVE28B**  
**1040DDMBVE28B**

145W 16000lm - 220V  
DALI (Push) - 145W 16000lm - 220V

**2.874,00 €**  
**3.100,00 €**

Configura

Configure / Konfigurieren

[www.teamitaliailluminazione.it](http://www.teamitaliailluminazione.it)

CE A

A 2700K  C 4000K

NE RU

**CODICE COMPLETO DEL PRODOTTO NELLA FOTO**  
FULL PRODUCT CODE AS SHOWN IN PICTURE - VOLLSTÄNDIGER CODE VOM ARTIKEL IM BILD

**1040COF** **NE** **E28** **B**

Codice  
Code

Finitura  
Finishing  
Lackierung

Diffusore  
Diffuser  
Diffusor

Tonalità  
Hue  
Farbton

BV NE RU

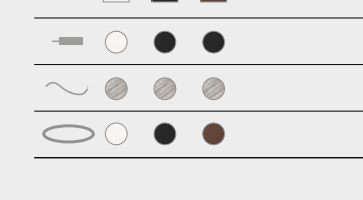

**A** Alimentatore nel rosone - Power Supply inside the ceiling rose - Netzteil in der Deckendose

\* 13000lm effettivi - effective - effektive con - with - mit **E28**

INDEX

SECTION

FAMILY 71



# BULBE

SOSPENSIONE  
SUSPENSION LAMP  
PENDELLEUCHE



configurazione standard: / basic configuration: / Standard Konfiguration:

OB

GU10

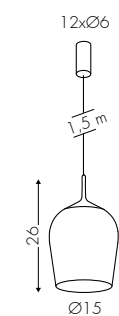

1078AOB

1x GU10 max 7W LED - 220V

240,00 €

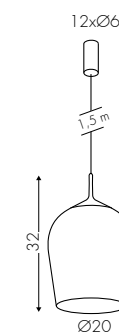

1078BOB

1x GU10 max 7W LED - 220V

275,00 €

Configura

Configure / Konfigurieren

[www.teamitaliailluminazione.it](http://www.teamitaliailluminazione.it)



CODICE COMPLETO DEL PRODOTTO NELLA FOTO  
FULL PRODUCT CODE AS SHOWN IN PICTURE - VOLLSTÄNDIGER CODE VOM ARTIKEL IM BILD

**1078B**

Codice  
Code

**ZN**

Finitura  
Finishing  
Lackierung

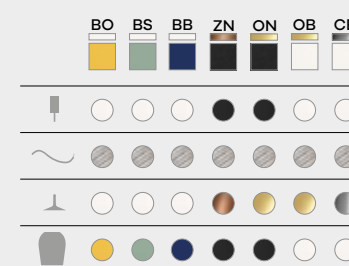

GU10 Sorgente GU10 non inclusa - GU10 light source not included - GU10 Lichtquelle nicht enthalten

INDEX

SECTION

FAMILY 73





# BULBE

SOSPENSIONE (composizione)  
SUSPENSION (composition)  
SUSPENSION (composition)



configurazione standard: / basic configuration: / Standard Konfiguration:

GU10

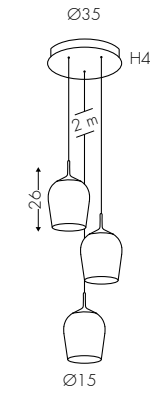

1078FOB

3x GU10 max 7W LED - 220V

720,00 €

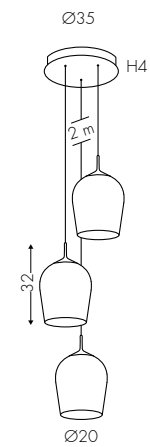

1078GOB

3x GU10 max 7W LED - 220V

825,00 €

Configura

Configure / Konfigurieren

[www.teamitaliailluminazione.it](http://www.teamitaliailluminazione.it)

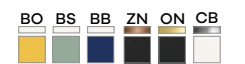

CODICE COMPLETO DEL PRODOTTO NELLA FOTO  
FULL PRODUCT CODE AS SHOWN IN PICTURE - VOLLSTÄNDIGER CODE VOM ARTIKEL IM BILD

**1078F**

Codice  
Code

**BB**

Finitura  
Finishing  
Lackierung

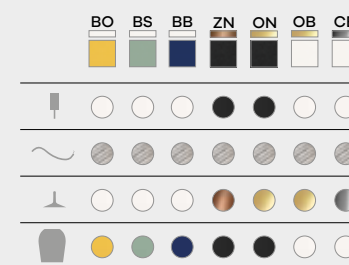

GU10 Sorgente GU10 non inclusa - GU10 light source not included - GU10 Lichtquelle nicht enthalten

INDEX

SECTION

FAMILY 75

# CHAPEAU

SOSPENSIONE  
SUSPENSION LAMP  
PENDELLEUCHE



configurazione standard: / basic configuration: / Standard Konfiguration:

E2 Opale - Opal

● B 3000K

BV

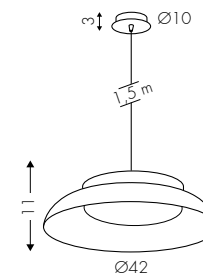

1087BTFBVE2B

18W 1620lm\* - 220V

430,00 €

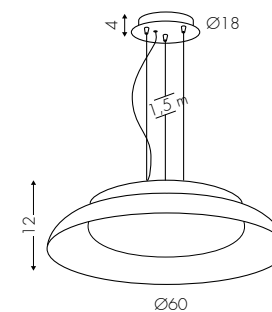

1087DTFBVE2B

30W 3000lm - 220V

560,00 €

Configura

Configure / Konfigurieren

[www.teamitaliailluminazione.it](http://www.teamitaliailluminazione.it)



**CODICE COMPLETO DEL PRODOTTO NELLA FOTO**  
FULL PRODUCT CODE AS SHOWN IN PICTURE - VOLLSTÄNDIGER CODE VOM ARTIKEL IM BILD

**1087BTF** **RV** **E2** **B**

Codice  
Code

Finitura  
Finishing  
Lackierung

Diffusore  
Diffuser  
Diffusor

Tonalità  
Hue  
Farbton

BV NE OV RV BR SV BY OC

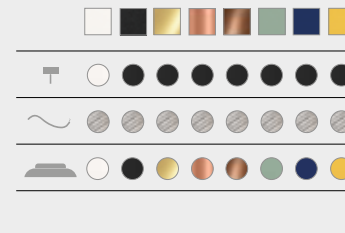

**TF** Taglio di Fase - Phase-Cut Dimmer - Phasenabschnittdimmer

**A** Alimentatore Incorporato - Incorporated Power Supply - Eingebautes Netzteil

\* 1620lm effettivi - effective - effektiven con - with - mit **E2**

INDEX

SECTION

FAMILY

77

# CURVE

SOSPENSIONE  
SUSPENSION LAMP  
PENDELLEUCHE



configurazione standard: / basic configuration: / Standard Konfiguration:

E2 Opale - Opal

● B 3000K

BV

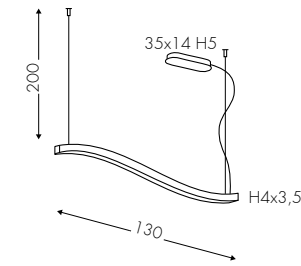

**1022NOFBVE2B**  
**1022NDMBVE2B**  
**1022NTFBVE2B**

35W 3570lm\* - 220V  
DALI (Push) - 35W 3570lm - 220V  
35W 3570lm - 220V

**568,00 €**  
**680,00 €**  
**620,00 €**

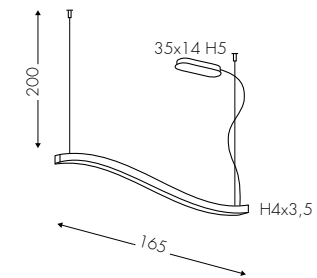

**1022MOFBVE2B**  
**1022MDMBVE2B**  
**1022MTFBVE2B**

45W 4675lm - 220V  
DALI (Push) - 45W 4675lm - 220V  
45W 4675lm - 220V

**625,00 €**  
**710,00 €**  
**662,00 €**

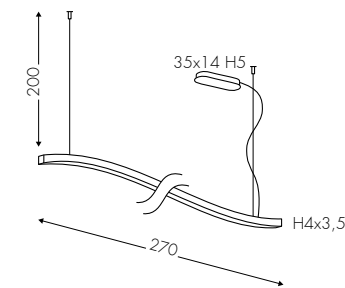

**1022HOFBVE2B**  
**1022HDMBVE2B**

70W 7565lm - 220V  
DALI (Push) - 70W 7565lm - 220V

**834,00 €**  
**967,00 €**

Configura

Configure / Konfigurieren

[www.teamitaliailluminazione.it](http://www.teamitaliailluminazione.it)



A

E19 Prismatico - Prism

● A 2700K

NE RU



**CODICE COMPLETO DEL PRODOTTO NELLA FOTO**  
FULL PRODUCT CODE AS SHOWN IN PICTURE - VOLLSTÄNDIGER CODE VOM ARTIKEL IM BILD

**1022MOF** **NE** **E2** **B**

Codice  
Code

Finitura  
Finishing  
Lackierung

Diffusore  
Diffuser  
Diffusor

Tonalità  
Hue  
Farbton

BV NE RU

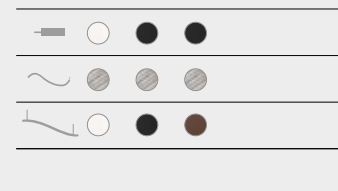

**TF** Taglio di Fase - Phase-Cut Dimmer - Phasenabschnittdimmer

**A** Alimentatore nel rosone - Power Supply inside the ceiling rose - Netzteil in der Deckendose

\* 3570lm effettivi - effective - effektive con - with - mit **E2**  
4200lm effettivi - effective - effektive con - with - mit **E19** **+17,5%**

INDEX

SECTION

FAMILY



configurazione standard: / basic configuration: / Standard Konfiguration:

E2 Opale - Opal

B 3000K

BV

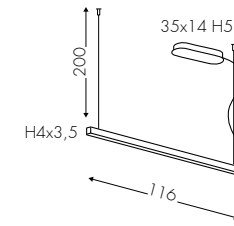

**1028SOFBVE2B**  
**1028SDMBVE2B**  
**1028TFBVE2B**

25W 2250lm\* - 220V  
DALI (Push) - 25W 2250lm - 220V  
25W 2250lm - 220V

**301,00 €**  
**350,00 €**  
**350,00 €**

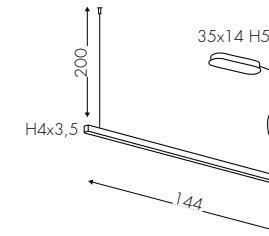

**1028TOFBVE2B**  
**1028TDMBVE2B**  
**1028TTFBVE2B**

31W 2790lm - 220V  
DALI (Push) - 31W 2790lm - 220V  
31W 2790lm - 220V

**344,00 €**  
**406,00 €**  
**406,00 €**

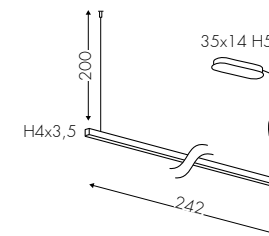

**1028UOFBVE2B**  
**1028UDMBVE2B**

52W 4680lm - 220V  
DALI (Push) - 52W 4680lm - 220V

**457,00 €**  
**552,00 €**

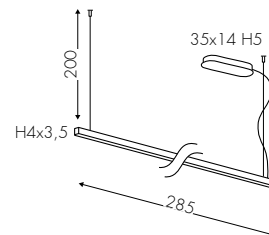

**1028VOFBVE2B**  
**1028VDMBVE2B**

62W 5590lm - 220V  
DALI (Push) - 62W 5590lm - 220V

**665,00 €**  
**768,00 €**

Configura

Configure / Konfigurieren

[www.teamitaliailluminazione.it](http://www.teamitaliailluminazione.it)



E19 UGR<19 Prism

A 2700K  C 4000K

NE RU



**CODICE COMPLETO DEL PRODOTTO NELLA FOTO**  
FULL PRODUCT CODE AS SHOWN IN PICTURE - VOLLSTÄNDIGER CODE VOM ARTIKEL IM BILD

**1028TOF** **NE** **E2** **B**

Codice  
Code

Finitura  
Finishing  
Lackierung

Diffusore  
Diffuser  
Diffusor

Tonalità  
Hue  
Farbton

BV NE RU

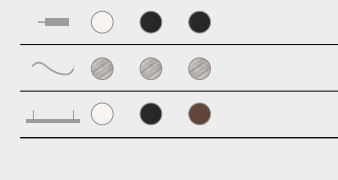

**TF** Taglio di Fase - Phase-Cut Dimmer - Erhältlich Phasenabschnittdimmer

**A** Alimentatore nel rosone - Power Supply inside the ceiling rose - Netzteil in der Deckendose

\* 2250lm effettivi - effective - effektive con - with - mit **E2**  
2600lm effettivi - effective - effektive con - with - mit **E19** **+17,5%**





configurazione standard: / basic configuration: / Standard Konfiguration:

E2 Opale - Opal

B 3000K

BV

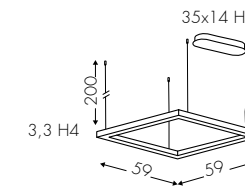

**1028BOFBVE2B**  
**1028BDMBVE2B**

50W 3650lm\* - 220V  
DALI (Push) - 50W 3650lm - 220V

**656,00 €**  
**750,00 €**

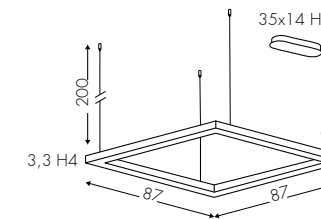

**1028COFBVE2B**  
**1028CDMBVE2B**

75W 5470lm - 220V  
DALI (Push) - 75W 5470lm - 220V

**903,00 €**  
**995,00 €**

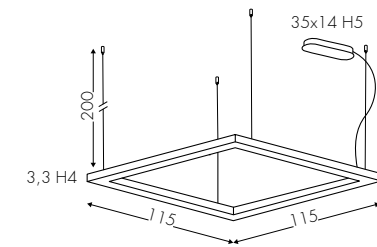

**1028DOFBVE2B**  
**1028DDMBVE2B**

100W 7300lm - 220V  
DALI (Push) - 100W 7300lm - 220V

**1.036,00 €**  
**1.158,00 €**

Configura

Configure / Konfigurieren

[www.teamitaliailluminazione.it](http://www.teamitaliailluminazione.it)



A

E19 UGR<19 Prism

A 2700K

C 4000K

NE RU



**CODICE COMPLETO DEL PRODOTTO NELLA FOTO**  
FULL PRODUCT CODE AS SHOWN IN PICTURE - VOLLSTÄNDIGER CODE VOM ARTIKEL IM BILD

**1028DDM** **NE** **E19** **B**

Codice  
Code

Finitura  
Finishing  
Lackierung

Diffusore  
Diffuser  
Diffusor

Tonalità  
Hue  
Farbton

BV NE RU



A Alimentatore nel rosone - Power Supply inside the ceiling rose - Netzteil in der Deckendose

\* 3650lm effettivi - effective - effektive con - with - mit E2  
4290lm effettivi - effective - effektive con - with - mit E19 +17,5%



# EDGE

SOSPENSIONE  
SUSPENSION LAMP  
PENDELLEUCHE



configurazione standard: / basic configuration: / Standard Konfiguration:

E2 Opale - Opal ● B 3000K

BV

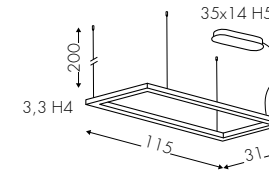

**1028E0FBVE2B**  
**1028EDMBVE2B**

62W 4560lm\* - 220V  
DALI (Push) - 62W 4560lm - 220V

**676,00 €**  
**772,00 €**

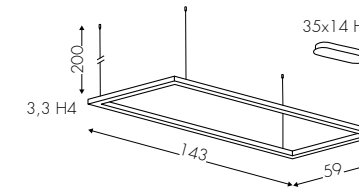

**1028H0FBVE2B**  
**1028HDMBVE2B**

88W 6420lm - 220V  
DALI (push) - 88W 6420lm - 220V

**1.036,00 €**  
**1.158,00 €**

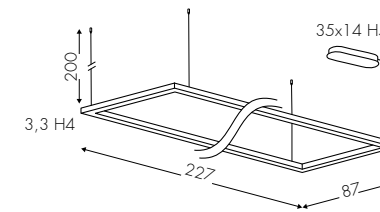

**1028G0FBVE2B**  
**1028GDMBVE2B**

138W 10020lm - 220V  
DALI (Push) - 138W 10020lm - 220V

**1.369,00 €**  
**1.534,00 €**

Configura Configure / Konfigurieren

[www.teamitaliailluminazione.it](http://www.teamitaliailluminazione.it)



E19 UGR<19 Prism ● A 2700K  C 4000K

NE RU

**CODICE COMPLETO DEL PRODOTTO NELLA FOTO**  
FULL PRODUCT CODE AS SHOWN IN PICTURE - VOLLSTÄNDIGER CODE VOM ARTIKEL IM BILD

**1028GOF** **NE** **E2** **B**

Codice  
Code

Finitura  
Finishing  
Lackierung

Diffusore  
Diffuser  
Diffusor

Tonalità  
Hue  
Farbton

BV NE RU

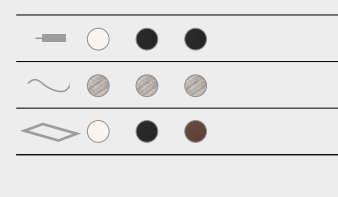

A Alimentatore nel rosone - Power Supply inside the ceiling rose - Netzteil in der Deckendose

\* 4560lm effettivi - effective - effektive con - with - mit E2  
5363lm effettivi - effective - effektive con - with - mit E19 ↻ +17,5%

INDEX

SECTION

FAMILY 85



# EDGE

SOSPENSIONE  
SUSPENSION LAMP  
PENDELLEUCHE



configurazione standard: / basic configuration: / Standard Konfiguration:

E28 Satinato  
Frosted - Satiniert

B 3000K

BV

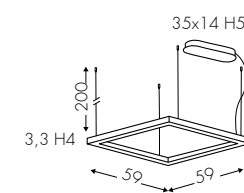

**1028BUPOFBVE28B** 50W 4290lm\* - 220V **656,00 €**  
**1028BUPDMBVE28B** DALI (Push) - 50W 4290lm - 220V **750,00 €**

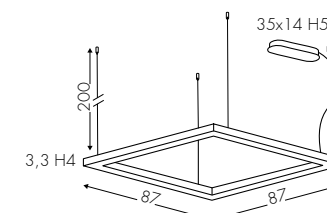

**1028CUPOFBVE28B** 75W 6435lm - 220V **903,00 €**  
**1028CUPDMBVE28B** DALI (Push) - 75W 6435lm - 220V **995,00 €**

Configura Configure / Konfigurieren

[www.teamitaliailluminazione.it](http://www.teamitaliailluminazione.it)

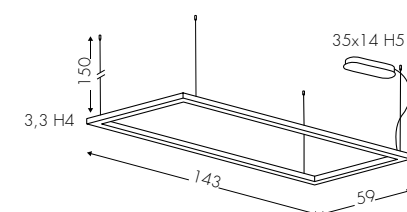

**1028HUPOFBVE28B** 88W 7550lm - 220V **1.036,00 €**  
**1028HUPDMBVE28B** DALI (push) - 88W 7550lm - 220V **1.158,00 €**

Configura Configure / Konfigurieren

[www.teamitaliailluminazione.it](http://www.teamitaliailluminazione.it)



A 2700K  C 4000K

NE RU

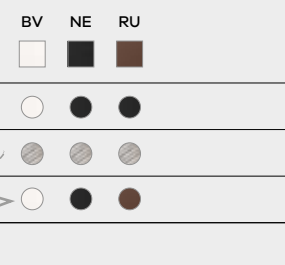

A Alimentatore nel rosone - Power Supply inside the ceiling rose - Netzteil in der Deckendose

\* 4290lm effettivi - effective - effektive con - with - mit E28



CODICE COMPLETO DEL PRODOTTO NELLA FOTO  
FULL PRODUCT CODE AS SHOWN IN PICTURE - VOLLSTÄNDIGER CODE VOM ARTIKEL IM BILD

**1028HUPOF** **NE** **E28** **B**

Codice Code	Finitura Finishing Lackierung	Diffusore Diffuser Diffusor	Tonalità Hue Farbton
----------------	-------------------------------------	-----------------------------------	----------------------------



# EDGE

SOSPENSIONE (composizione)  
SUSPENSION (composition)  
SUSPENSION (composition)



configurazione standard: / basic configuration: / Standard Konfiguration:

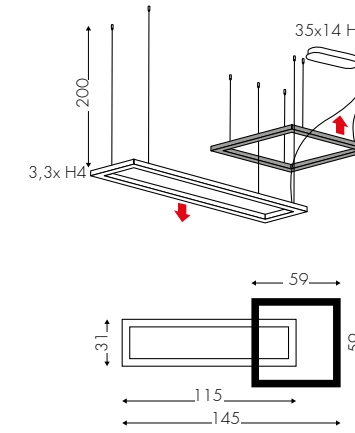

E2 Opale - Opal ● B 3000K



<b>1028NOFBVE2B</b>	62W 4560lm* + 50W 4290lm - 220V	<b>1.307,00 €</b>
<b>1028NDMBVE2B</b>	DALI (Push) - 62W 4560lm + 50W 4290lm - 220V	<b>1.404,00 €</b>
<b>1028NBTBVE2B</b>	Bluetooth 62W 4560lm + 50W 4290lm - 220V	<b>1.404,00 €</b>

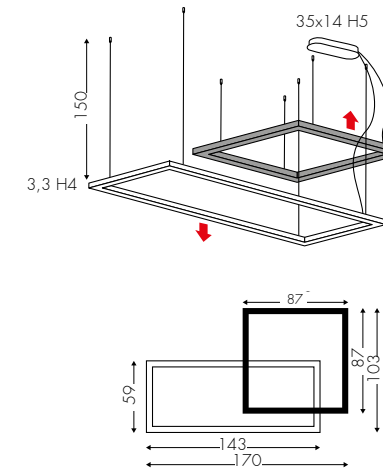

<b>1028MOFBVE2B</b>	75W 5470lm + 44W 3880lm - 220V	<b>1.875,00 €</b>
<b>1028MDMBVE2B</b>	DALI (Push) - 75W 5470lm + 44W 3880lm - 220V	<b>1.989,00 €</b>
<b>1028MBTBVE2B</b>	Bluetooth 75W 5470lm + 44W 3880lm - 220V	<b>1.989,00 €</b>

Configura Configure / Konfigurieren

[www.teamitaliailluminazione.it](http://www.teamitaliailluminazione.it)



E19 UGR<19 Prism ● A 2700K



**CODICE COMPLETO DEL PRODOTTO NELLA FOTO**  
FULL PRODUCT CODE AS SHOWN IN PICTURE - VOLLSTÄNDIGER CODE VOM ARTIKEL IM BILD

**1028NOF** **BN** **E2** **B**

Codice Code	Finitura Finishing Lackierung	Diffusore Diffuser Diffusor	Tonalità Hue Farbton
----------------	-------------------------------------	-----------------------------------	----------------------------

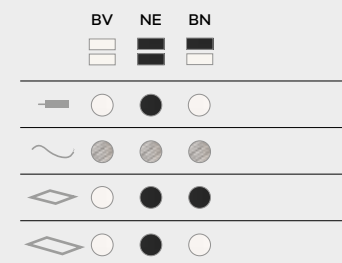

**BT** Bluetooth - Bluetooth - Bluetooth  
**A** Alimentatore nel rosone - Power Supply in the ceiling rose - Netzteil in der Deckendose

\* 4560lm effettivi - effective - effektive con - with - mit **E2**  
5363lm effettivi - effective - effektive con - with - mit **E19** ↻ +17,5%





configurazione standard: / basic configuration: / Standard Konfiguration:

E2 Opale - Opal ● B 3000K

BV

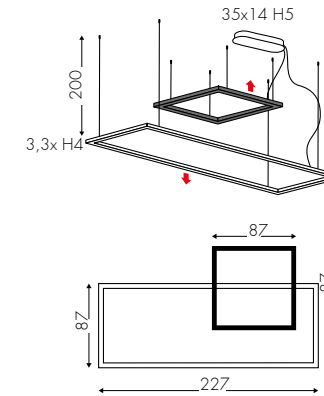

<b>1028OOFBVE2B</b>	96W 6955lm* + 35W 2964lm - 220V	<b>2.316,00 €</b>
<b>1028ODMBVE2B</b>	DALI (Push) - 96W 6955lm + 35W 2964lm - 220V	<b>2.447,00 €</b>
<b>1028OBTBVE2B</b>	Bluetooth 96W 6955lm + 35W 2964lm - 220V	<b>2.447,00 €</b>

Configura Configure / Konfigurieren

[www.teamitaliailluminazione.it](http://www.teamitaliailluminazione.it)



E19 UGR<19 Prism ● A 2700K

NE BN

**CODICE COMPLETO DEL PRODOTTO NELLA FOTO**  
FULL PRODUCT CODE AS SHOWN IN PICTURE - VOLLSTÄNDIGER CODE VOM ARTIKEL IM BILD

**1028OOF** **BN** **E2** **B**

Codice  
Code

Finitura  
Finishing  
Lackierung

Diffusore  
Diffuser  
Diffusor

Tonalità  
Hue  
Farbton

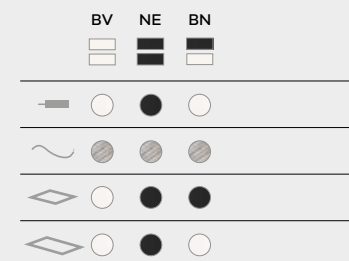

**BT** Bluetooth - Bluetooth - Bluetooth  
**A** Alimentatore nel rosone - Power Supply in the ceiling rose - Netzteil in der Deckendose

\* 6955lm effettivi - effective - effektive con - with - mit **E2**  
8181lm effettivi - effective - effektive con - with - mit **E19** **+17,5%**



# EMME 24

SOSPENSIONE (composizione)  
SUSPENSION (composition)  
SUSPENSION (composition)



configurazione standard: / basic configuration: / Standard Konfiguration:

E2 Opale - Opal ● B 3000K



**1037SOFBVE2B**  
**1037SDMBVE2B**

184W 13540lm\* - 220V  
DALI (Push) - 184W 13540lm - 220V

**2.145,00 €**  
**2.232,00 €**

Configura Configure / Konfigurieren

[www.teamitaliailluminazione.it](http://www.teamitaliailluminazione.it)

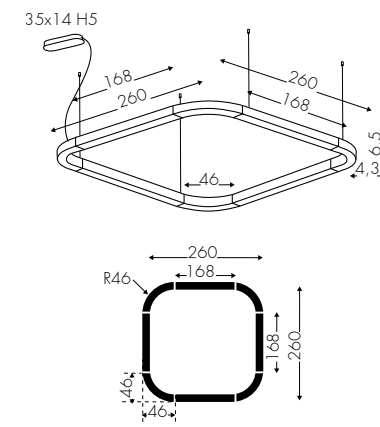
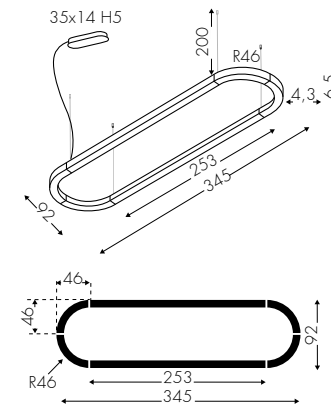

**1037TOFBVE2B**  
**1037TDMBVE2B**

220W 16355lm - 220V  
DALI (Push) - 220W 16355lm - 220V

**2.565,00 €**  
**2.652,00 €**

Configura Configure / Konfigurieren

[www.teamitaliailluminazione.it](http://www.teamitaliailluminazione.it)



E19 UGR<19 Prism ○ C 4000K



A Alimentatore nel rosone - Power Supply inside the ceiling rose - Netzteil in der Deckendose

\* 13540lm effettivi - effective - effektive con - with - mit E2  
15920lm effettivi - effective - effektive con - with - mit E19 ↻ +17,5%

**CODICE COMPLETO DEL PRODOTTO NELLA FOTO**  
FULL PRODUCT CODE AS SHOWN IN PICTURE - VOLLSTÄNDIGER CODE VOM ARTIKEL IM BILD

**1037SOF** **NE** **E19** **B**

Codice Code	Finitura Finishing Lackierung	Diffusore Diffuser Diffusor	Tonalità Hue Farbton
----------------	-------------------------------------	-----------------------------------	----------------------------

BV NE





configurazione standard: / basic configuration: / Standard Konfiguration:

E2 Opale - Opal ● B 3000K

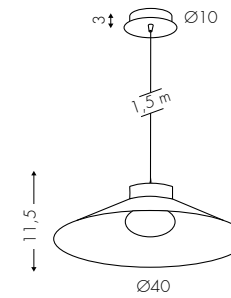

**1076CTFNEE2B**

17W 1100lm\* - 220V

**395,00 €**

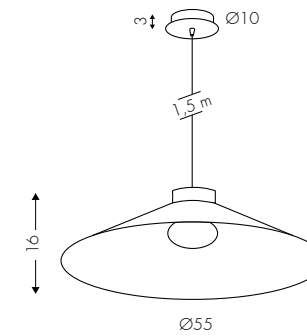

**1076DTFNEE2B**

17W 1100lm - 220V

**480,00 €**

**C005T2NE** Custom black cable

**8,00 € /MT**

Configura Configure / Konfigurieren

[www.teamitaliailluminazione.it](http://www.teamitaliailluminazione.it)



● A 2700K



**CODICE COMPLETO DEL PRODOTTO NELLA FOTO**  
FULL PRODUCT CODE AS SHOWN IN PICTURE - VOLLSTÄNDIGER CODE VOM ARTIKEL IM BILD

**1076CTF ON E2 A**

Codice Code	Finitura Finishing Lackierung	Diffusore Diffuser Diffusor	Tonalità Hue Farbton
----------------	-------------------------------------	-----------------------------------	----------------------------

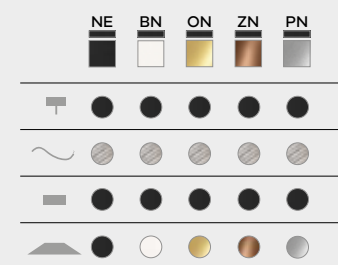

**TF** Taglio di Fase - Phase-Cut Dimmer - Phasenabschnittdimmer  
**A** Alimentatore Incorporato - Incorporated Power Supply - Eingebautes Netzteil

\* 1100lm effettivi - effective - effektiven con - with - mit **E2**



# LAMBDA

SOSPENSIONE  
SUSPENSION LAMP  
PENDELLEUCHE



configurazione standard: / basic configuration: / Standard Konfiguration:

E19 Prismatico - Prism ● B 3000K ON

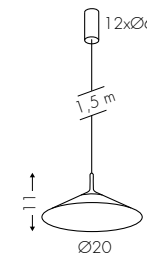

1071PTFONE19B 6,5W 800lm\* - 220V 292,00 €

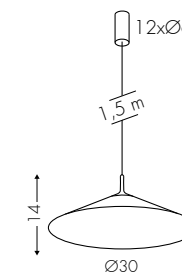

1071QTFONE19B 6,5W 800lm - 220V 372,00 €

C005A2TR Custom transparent cable 7,00 € /MT

Configura Configure / Konfigurieren

[www.teamitaliailluminazione.it](http://www.teamitaliailluminazione.it)



● A 2700K ZN PN

CODICE COMPLETO DEL PRODOTTO NELLA FOTO  
FULL PRODUCT CODE AS SHOWN IN PICTURE - VOLLSTÄNDIGER CODE VOM ARTIKEL IM BILD

**1071QTF** **PN** **E19** **A**

Codice  
Code

Finitura  
Finishing  
Lackierung

Diffusore  
Diffuser  
Diffusor

Tonalità  
Hue  
Farbton

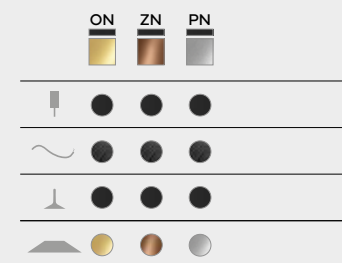

TF Taglio di Fase - Phase-Cut Dimmer - Phasenabschrittdimmer

A Alimentatore nel rosone - Power Supply inside the ceiling rose - Netzteil in der Deckendose

\* 800lm effettivi - effective - effektiven con - with - mit E19





# LAMBDA

SOSPENSIONE (composizione)  
SUSPENSION (composition)  
SUSPENSION (composition)



configurazione standard: / basic configuration: / Standard Konfiguration:

E19 Prismatico - Prism ● B 3000K ON

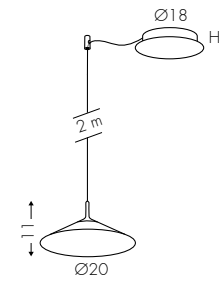

1071RTFONE19B 6,5W 800lm\* - 220V 306,00 €

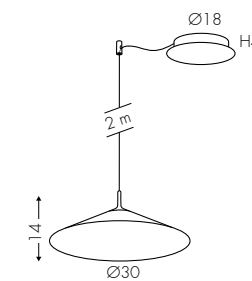

1071STFONE19B 6,5W 800lm - 220V 386,00 €

[Configura](#) Configure / Konfigurieren

[www.teamitaliailluminazione.it](http://www.teamitaliailluminazione.it)

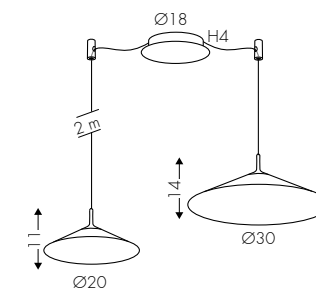

1071TTFONE19B 2x6,5W 2x800lm - 220V 650,00 €

C005A2TR Custom transparent cable 7,00 € /MT

[Configura](#) Configure / Konfigurieren

[www.teamitaliailluminazione.it](http://www.teamitaliailluminazione.it)



● A 2700K ZN PN

**CODICE COMPLETO DEL PRODOTTO NELLA FOTO**  
FULL PRODUCT CODE AS SHOWN IN PICTURE - VOLLSTÄNDIGER CODE VOM ARTIKEL IM BILD

**1071TTF** **PN** **E19** **B**

Codice Code	Finitura Finishing Lackierung	Diffusore Diffuser Diffusor	Tonalità Hue Farbton
----------------	-------------------------------------	-----------------------------------	----------------------------

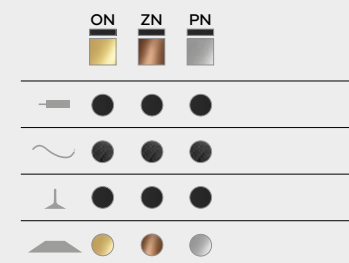

**TF** Taglio di Fase - Phase-Cut Dimmer - Phasenabschnittdimmer  
**A** Alimentatore nel rosone - Power Supply inside the ceiling rose - Netzteil in der Deckendose

\* 800lm effettivi - effective - effektiven con - with - mit **E19**



# LAMBDA

SOSPENSIONE (composizione)  
SUSPENSION (composition)  
SUSPENSION (composition)



configurazione standard: / basic configuration: / Standard Konfiguration:

E19 Prismatico - Prism ● B 3000K ON 

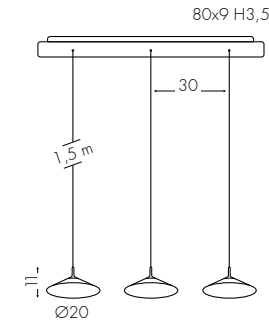

**1071DTFONE19B** 3x6,5W 3x800lm\* - 220V

**990,00 €**

Configura  Configure / Konfigurieren

[www.teamitaliailluminazione.it](http://www.teamitaliailluminazione.it) 

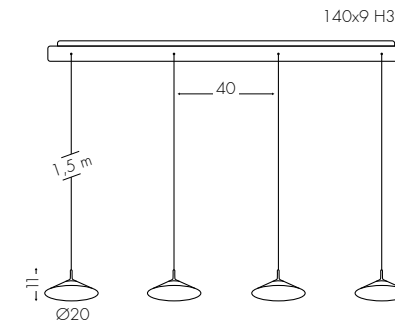

**1071ETONE19B** 4x6,5W 4x800lm - 220V

**1.290,00 €**

 **C005A2TR** Custom transparent cable

**7,00 € /MT**

Configura  Configure / Konfigurieren

[www.teamitaliailluminazione.it](http://www.teamitaliailluminazione.it) 



● **A 2700K** ZN  PN 

 **CODICE COMPLETO DEL PRODOTTO NELLA FOTO**  
FULL PRODUCT CODE AS SHOWN IN PICTURE - VOLLSTÄNDIGER CODE VOM ARTIKEL IM BILD

**1071ETF** **ON** **E19** **A**

Codice Code	Finitura Finishing Lackierung	Diffusore Diffuser Diffusor	Tonalità Hue Farbton
----------------	-------------------------------------	-----------------------------------	----------------------------

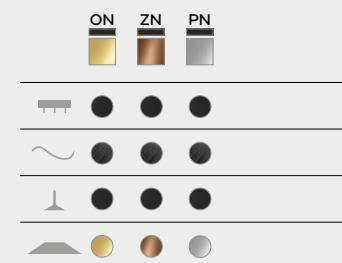

**A** Alimentatore nel rosone - Power Supply inside the ceiling rose - Netzteil in der Deckendose

**TF** Taglio di Fase - Phase-Cut Dimmer - Phasenabschrittdimmer

\* 800lm effettivi - effective - effektiven con - with - mit **E19**



# LAMBDA

SOSPENSIONE (composizione)  
SUSPENSION (composition)  
SUSPENSION (composition)



configurazione standard: / basic configuration: / Standard Konfiguration:

E19 Prismatico - Prism ● B 3000K ON

1071FTFONE19B 3x6,5W 3x800lm\* - 220V

850,00 €

[Configura](#) Configure / Konfigurieren

[www.teamitaliailluminazione.it](http://www.teamitaliailluminazione.it)

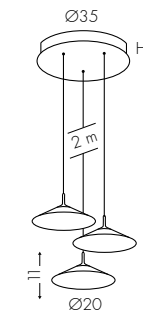

1071GTFONE19B 6x6,5W 6x800lm - 220V

1.800,00 €

C005A2TR Custom transparent cable 7,00 € /MT

[Configura](#) Configure / Konfigurieren

[www.teamitaliailluminazione.it](http://www.teamitaliailluminazione.it)

● A

● A 2700K ZN PN

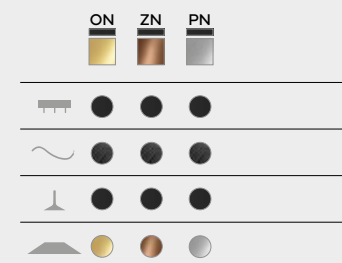

A Alimentatore nel rosone - Power Supply inside the ceiling rose - Netzteil in der Deckendose  
TF Taglio di Fase - Phase-Cut Dimmer - Phasenabschrittdimmer

\* 800lm effettivi - effective - effektiven con - with - mit E19

CODICE COMPLETO DEL PRODOTTO NELLA FOTO  
FULL PRODUCT CODE AS SHOWN IN PICTURE - VOLLSTÄNDIGER CODE VOM ARTIKEL IM BILD

**1071FGTF** **ZN** **E19** **A**

Codice Code	Finitura Finishing Lackierung	Diffusore Diffuser Diffusor	Tonalità Hue Farbton
----------------	-------------------------------------	-----------------------------------	----------------------------



# LEGGERA

SOSPENSIONE  
SUSPENSION LAMP  
PENDELLEUCHE



configurazione standard: / basic configuration: / Standard Konfiguration:

E2 Opale - Opal

● B 3000K

BV

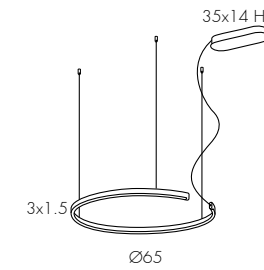

**1032AOFBVE2B**  
**1032ADMBVE2B**  
**1032ATFBVE2B**

35W 1740lm\* - 220V  
DALI (Push) - 35W 1740lm - 220V  
35W 1740lm - 220V

**656,00 €**  
**739,00 €**  
**739,00 €**

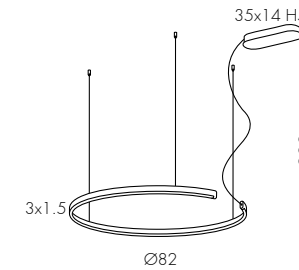

**1032BOFBVE2B**  
**1032BDMBVE2B**  
**1032BTFBVE2B**

48W 2580lm - 220V  
DALI (Push) - 48W 2580lm - 220V  
48W 2580lm - 220V

**766,00 €**  
**869,00 €**  
**869,00 €**

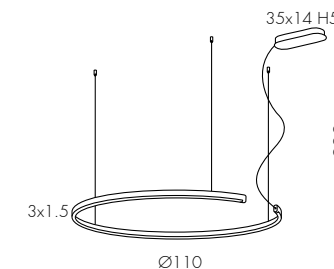

**1032COFBVE2B**  
**1032CDMBVE2B**  
**1032CTFBVE2B**

65W 3300lm - 220V  
DALI (Push) - 65W 3300lm - 220V  
65W 3300lm - 220V

**947,00 €**  
**1.060,00 €**  
**1.060,00 €**

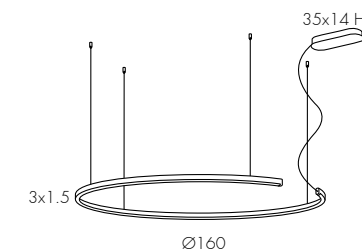

**1032DOFBVE2B**  
**1032DDMBVE2B**  
**1032DTFBVE2B**

90W 4980lm - 220V  
DALI (Push) - 90W 4980lm - 220V  
90W 4980lm - 220V

**1.452,00 €**  
**1.582,00 €**  
**1.582,00 €**

Configura

Configure / Konfigurieren

[www.teamitaliailluminazione.it](http://www.teamitaliailluminazione.it)



A

E2 Opale - Opal

● A 2700K

NE RV BR OV

**CODICE COMPLETO DEL PRODOTTO NELLA FOTO**  
FULL PRODUCT CODE AS SHOWN IN PICTURE - VOLLSTÄNDIGER CODE VOM ARTIKEL IM BILD

**1032COF** **BR** **E2** **B**

Codice  
Code

Finitura  
Finishing  
Lackierung

Diffusore  
Diffuser  
Diffusor

Tonalità  
Hue  
Farbton

BV NE RV BR OV

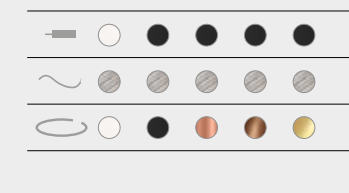

**TF** Taglio di Fase - Phase-Cut Dimmer - Phasenabschnittdimmer

**A** Alimentatore nel rosone - Power Supply inside the ceiling rose - Netzteil in der Deckendose

\* 1740lm effettivi - effective - effektive con - with - mit **E2**

INDEX

SECTION

FAMILY 105





# LEGGERA

SOSPENSIONE (composizione)  
SUSPENSION (composition)  
SUSPENSION (composition)



configurazione standard: / basic configuration: / Standard Konfiguration:

E2 Opale - Opal ● B 3000K

BV

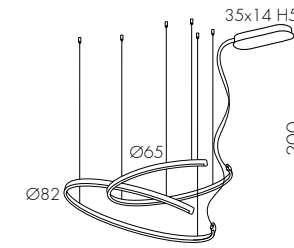

<b>1032ABOFBVE2B</b>	83W 4320lm* - 220V	<b>1.506,00 €</b>
<b>1032ABDMBVE2B</b>	DALI (Push) - 83W 4320lm - 220V	<b>1.635,00 €</b>
<b>1032ABTFBVE2B</b>	83W 4320lm - 220V	<b>1.635,00 €</b>

Configura Configure / Konfigurieren

[www.teamitaliailluminazione.it](http://www.teamitaliailluminazione.it)

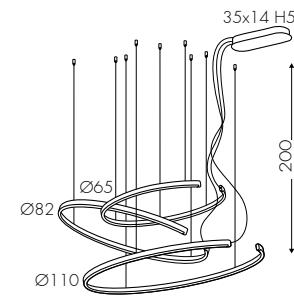

<b>1032ABCOFBVE2B</b>	148W 7620lm - 220V	<b>2.434,00 €</b>
<b>1032ABCDMBVE2B</b>	DALI (Push) - 148W 7620lm - 220V	<b>2.585,00 €</b>
<b>1032ABCTFBVE2B</b>	148W 7620lm - 220V	<b>2.585,00 €</b>

Configura Configure / Konfigurieren

[www.teamitaliailluminazione.it](http://www.teamitaliailluminazione.it)



● A 2700K



**CODICE COMPLETO DEL PRODOTTO NELLA FOTO**  
FULL PRODUCT CODE AS SHOWN IN PICTURE - VOLLSTÄNDIGER CODE VOM ARTIKEL IM BILD

**1032ABCOF** **OV** **E2** **B**

Codice Code	Finitura Finishing Lackierung	Diffusore Diffuser Diffusor	Tonalità Hue Farbton
----------------	-------------------------------------	-----------------------------------	----------------------------

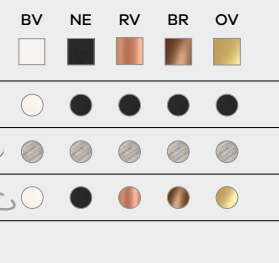

**TF** Taglio di Fase - Phase-Cut Dimmer - Phasenabschnittdimmer  
**A** Alimentatore nel rosone - Power Supply inside the ceiling rose - Netzteil in der Deckendose

\* 4320lm effettivi - effective - effektive con - with - mit **E2**



# LICIS

SOSPENSIONE  
SUSPENSION LAMP  
PENDELLEUCHE



configurazione standard: / basic configuration: / Standard Konfiguration:

E2 Opale - Opal - Opal ● B 3000K



1073ATFNTE2B 6,5W 800lm\* - 220V

350,00 €

Configura Configure / Konfigurieren

[www.teamitaliailluminazione.it](http://www.teamitaliailluminazione.it)

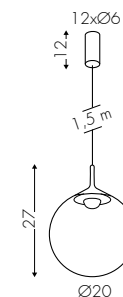

1073BTFNTE2B 6,5W 800lm - 220V

370,00 €

Configura Configure / Konfigurieren

[www.teamitaliailluminazione.it](http://www.teamitaliailluminazione.it)



● A 2700K



**CODICE COMPLETO DEL PRODOTTO NELLA FOTO**  
FULL PRODUCT CODE AS SHOWN IN PICTURE - VOLLSTÄNDIGER CODE VOM ARTIKEL IM BILD

**1073ATF** **NT** **E2** **A**

Codice  
Code

Finitura  
Finishing  
Lackierung

Diffusore  
Diffuser  
Diffusor

Tonalità  
Hue  
Farbton

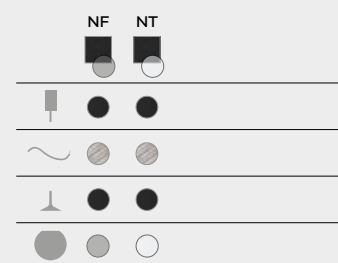

**TF** Taglio di Fase - Phase-Cut Dimmer - Phasenabschnittdimmer

**A** Alimentatore nel rosone - Power Supply inside the ceiling rose - Netzteil in der Deckendose

\* 800lm effettivi - effective - effektive con - with - mit **E2**





# LICIS

SOSPENSIONE (composizione)  
SUSPENSION (composition)  
SUSPENSION (composition)



configurazione standard: / basic configuration: / Standard Konfiguration:

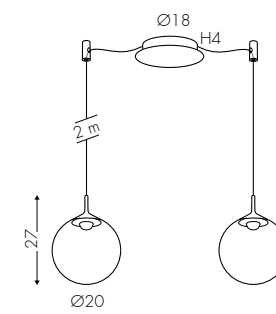

E2 Opale - Opal - Opal ● B 3000K



1073CTFNTE2B 2x6,5W 2x800lm\* - 220V

590,00 €

Configura Configure / Konfigurieren

[www.teamitaliailluminazione.it](http://www.teamitaliailluminazione.it)

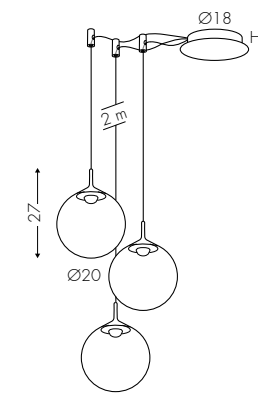

1073DTFNTE2B 3x6,5W 3x800lm - 220V

795,00 €

● C005T2NE Custom black cable

8,00 € /MT

Configura Configure / Konfigurieren

[www.teamitaliailluminazione.it](http://www.teamitaliailluminazione.it)



● A 2700K



CODICE COMPLETO DEL PRODOTTO NELLA FOTO  
FULL PRODUCT CODE AS SHOWN IN PICTURE · VOLLSTÄNDIGER CODE VOM ARTIKEL IM BILD

**1073DTF** **NT** **E2** **B**

Codice Code	Finitura Finishing Lackierung	Diffusore Diffuser Diffusor	Tonalità Hue Farbton
----------------	-------------------------------------	-----------------------------------	----------------------------

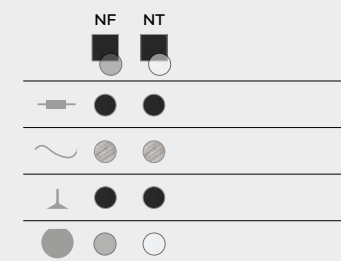

**TF** Taglio di Fase - Phase-Cut Dimmer - Phasenabschnittdimmer

**A** Alimentatore nel rosone - Power Supply inside the ceiling rose - Netzteil in der Deckendose

\* 800lm effettivi - effective - effektive con - with - mit **E2**



# LICIS

SOSPENSIONE (composizione)  
SUSPENSION (composition)  
SUSPENSION (composition)



configurazione standard: / basic configuration: / Standard Konfiguration:

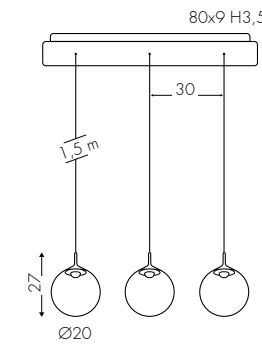

E2 Opale - Opal - Opal ● B 3000K



**1073ETFNTE2B** 3x6,5W 3x800lm\* - 220V

**990,00 €**

Configura Configure / Konfigurieren

[www.teamitaliailluminazione.it](http://www.teamitaliailluminazione.it)

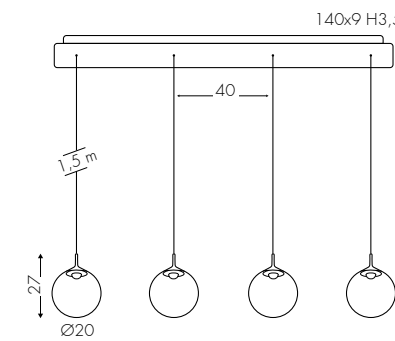

**1073FTFNTE2B** 4x6,5W 4x800lm - 220V

**1.350,00 €**

● **CO05T2NE** Custom black cable

**8,00 € /MT**

Configura Configure / Konfigurieren

[www.teamitaliailluminazione.it](http://www.teamitaliailluminazione.it)



● A 2700K



**CODICE COMPLETO DEL PRODOTTO NELLA FOTO**  
FULL PRODUCT CODE AS SHOWN IN PICTURE - VOLLSTÄNDIGER CODE VOM ARTIKEL IM BILD

**1073ETFNTE2A**

Codice Code	Finitura Finishing Lackierung	Diffusore Diffuser Diffusor	Tonalità Hue Farbton
----------------	-------------------------------------	-----------------------------------	----------------------------

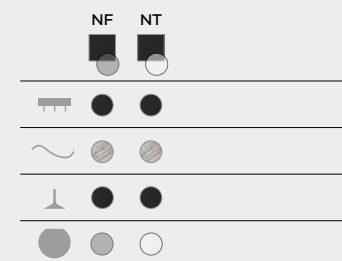

**TF** Taglio di Fase - Phase-Cut Dimmer - Phasenabschnittdimmer

**A** Alimentatore nel rosone - Power Supply inside the ceiling rose - Netzteil in der Deckendose

\* 800lm effettivi - effective - effektive con - with - mit **E2**





# LICIS

SOSPENSIONE (composizione)  
SUSPENSION (composition)  
SUSPENSION (composition)



configurazione standard: / basic configuration: / Standard Konfiguration:

E2 Opale - Opal - Opal ● B 3000K



1073GTFNTE2B 3x6,5W 3x800lm\* - 220V

1.100,00 €

Configura Configure / Konfigurieren

[www.teamitaliailluminazione.it](http://www.teamitaliailluminazione.it)

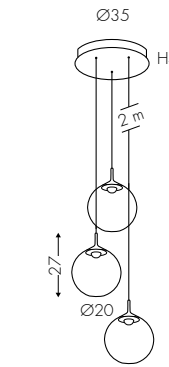

1073HTFNTE2B 6x6,5W 6x800lm - 220V

1.950,00 €

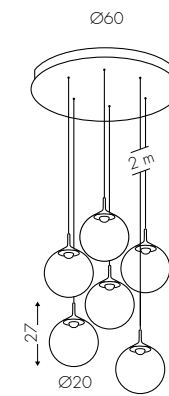

C005T2NE Custom black cable

8,00 € /MT

Configura Configure / Konfigurieren

[www.teamitaliailluminazione.it](http://www.teamitaliailluminazione.it)



● A 2700K



CODICE COMPLETO DEL PRODOTTO NELLA FOTO  
FULL PRODUCT CODE AS SHOWN IN PICTURE · VOLLSTÄNDIGER CODE VOM ARTIKEL IM BILD

**1073HTF** **NT** **E2** **B**

Codice Code	Finitura Finishing Lackierung	Diffusore Diffuser Diffusor	Tonalità Hue Farbton
----------------	-------------------------------------	-----------------------------------	----------------------------

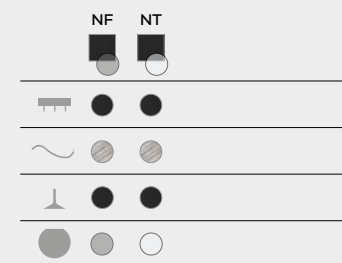

TF Taglio di Fase - Phase-Cut Dimmer - Phasenabschnittdimmer  
A Alimentatore nel rosone - Power Supply inside the ceiling rose - Netzteil in der Deckendose

\* 800lm effettivi - effective - effektive con - with - mit E2



configurazione standard: / basic configuration: / Standard Konfiguration:

E2 Opale - Opal

B 3000K

BV

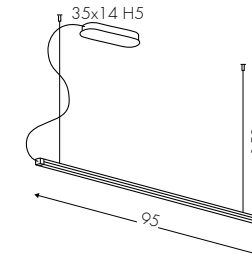

**1016AOFBVE2B**  
**1016ADMBVE2B**

21W 1420lm\* - 220V  
DALI (Push) - 21W 1420lm - 220V

**319,00 €**  
**418,00 €**

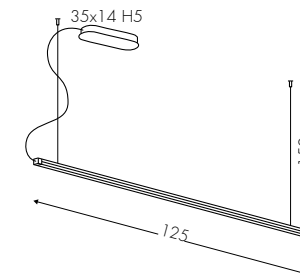

**1016BOFBVE2B**  
**1016BDMBVE2B**

28W 1890lm - 220V  
DALI (Push) - 28W 1890lm - 220V

**342,00 €**  
**442,00 €**

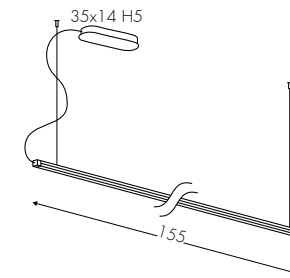

**1016COFBVE2B**  
**1016CDMBVE2B**

35W 2350lm - 220V  
DALI (Push) - 35W 2350lm - 220V

**371,00 €**  
**471,00 €**

C005T2BV

Custom white cable

**8,00 € /MT**

C005T2RO

Custom red cable

**8,00 € /MT**

Configura

Configure / Konfigurieren

[www.teamitaliailluminazione.it](http://www.teamitaliailluminazione.it)



A 2700K

BV



**CODICE COMPLETO DEL PRODOTTO NELLA FOTO**  
FULL PRODUCT CODE AS SHOWN IN PICTURE - VOLLSTÄNDIGER CODE VOM ARTIKEL IM BILD

**1016AOF**

**BV**

**E2**

**B**

Codice  
Code

Finitura  
Finishing  
Lackierung

Diffusore  
Diffuser  
Diffusor

Tonalità  
Hue  
Farbton

BV

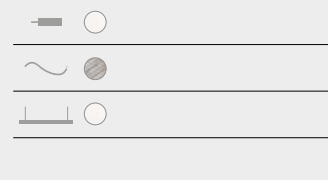

A Alimentatore nel rosone - Power Supply inside the ceiling rose - Netzteil in der Deckendose

\* 1420lm effettivi - effective - effektive con - with - mit E2

# LINEA DARK

SOSPENSIONE  
SUSPENSION LAMP  
PENDELLEUCHE



configurazione standard: / basic configuration: / Standard Konfiguration:

E19 UGR<19 Prism

B 3000K

BV

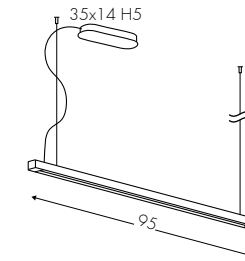

1021AOFBVE19B

21W 2200lm\* + 5W 425lm - 220V

341,00 €

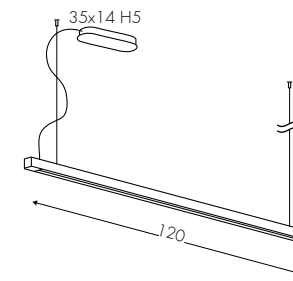

1021BOFBVE19B

27W 2320lm + 5W 425lm - 220V

364,00 €

1021BDMBVE19B

DALI (Push) - 27W 2320lm + 5W 425lm - 220V

467,00 €

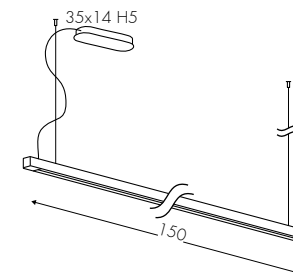

1021COFBVE19B

35W 2975lm + 5W 425lm - 220V

399,00 €

1021CDMBVE19B

DALI (Push) - 35W 2975lm + 5W 425lm - 220V

506,00 €

Configura

Configure / Konfigurieren

[www.teamitaliailluminazione.it](http://www.teamitaliailluminazione.it)



A 2700K

NE RU

**CODICE COMPLETO DEL PRODOTTO NELLA FOTO**  
FULL PRODUCT CODE AS SHOWN IN PICTURE - VOLLSTÄNDIGER CODE VOM ARTIKEL IM BILD

**1021BOF** **NE** **E19** **B**

Codice  
Code

Finitura  
Finishing  
Lackierung

Diffusore  
Diffuser  
Diffusor

Tonalità  
Hue  
Farbton

BV NE RU

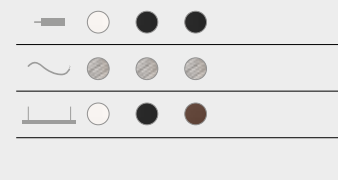

**A** Alimentatore nel rosone - Power Supply inside the ceiling rose - Netzteil in der Deckendose

\* 2200lm effettivi - effective - effektive con - with - mit **E19**

INDEX

SECTION

FAMILY 119



# MELLOW

SOSPENSIONE (composizione)  
SUSPENSION (composition)  
SUSPENSION (composition)



configurazione standard: / basic configuration: / Standard Konfiguration:

E2 Opale - Opal - Opal ● B 3000K



**1083ATFBVE2B** 6,5W 900lm\* - 220V

**370,00 €**

Configura Configure / Konfigurieren

[www.teamitaliailluminazione.it](http://www.teamitaliailluminazione.it)

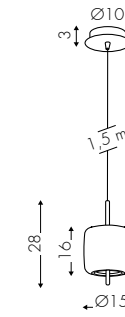

**1083GTFBVE2B** 3x6,5W 3x900lm - 220V

**835,00 €**

Configura Configure / Konfigurieren

[www.teamitaliailluminazione.it](http://www.teamitaliailluminazione.it)

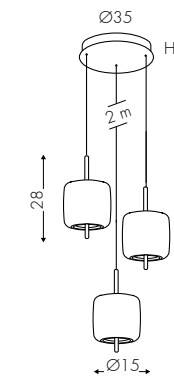

**1083HTFBVE2B** 6x6,5W 6x900lm - 220V

**2.050,00 €**

**CO05T2NE** Custom black cable

**8,00 € /MT**

Configura Configure / Konfigurieren

[www.teamitaliailluminazione.it](http://www.teamitaliailluminazione.it)



● A 2700K

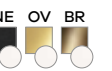

**CODICE COMPLETO DEL PRODOTTO NELLA FOTO**  
FULL PRODUCT CODE AS SHOWN IN PICTURE - VOLLSTÄNDIGER CODE VOM ARTIKEL IM BILD

**1083GTF** **OV** **E2** **B**

Codice Code	Finitura Finishing Lackierung	Diffusore Diffuser Diffusor	Tonalità Hue Farbton
----------------	-------------------------------------	-----------------------------------	----------------------------

	<b>BV</b>	<b>NE</b>	<b>BR</b>	<b>OV</b>
	<input type="radio"/>	<input type="radio"/>	<input type="radio"/>	<input type="radio"/>
	<input type="radio"/>	<input type="radio"/>	<input type="radio"/>	<input type="radio"/>
	<input type="radio"/>	<input type="radio"/>	<input type="radio"/>	<input type="radio"/>
	<input type="radio"/>	<input type="radio"/>	<input type="radio"/>	<input type="radio"/>

**TF** Taglio di Fase - Phase-Cut Dimmer - Phasenabschnittdimmer

**A** Alimentatore nel rosone - Power Supply inside the ceiling rose - Netzteil in der Deckendose

\* 900lm effettivi - effective - effektive con - with - mit **E2**

# MIRÓ HOME

UPLIGHT - DOWNLIGHT

SOSPENSIONE  
SUSPENSION LAMP  
PENDELLEUCHE



configurazione standard: / basic configuration: / Standard Konfiguration:

+ E2 Opale - Opal  
24° Ottica - Optic - Optik

B 3000K

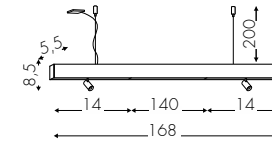

**1030D11OFBVE2B** Spot 2x7W 2x680lm  
44W 3761lm\* + 18W 2390lm - 220V

829,00 €

**1030D11DMBVE2B** DALI (Push) - Spot 2x7W 2x680lm  
44W 3761lm + 18W 2390lm - 220V

1.146,00 €

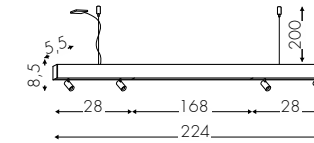

**1030F22OFBVE2B** Spot 4x7W 4x680lm  
53W 4513lm + 18W 2390lm - 220V

1.135,00 €

**1030F22DMBVE2B** DALI (Push) - Spot 4x7W 4x680lm  
53W 4513lm + 18W 2390lm - 220V

1.491,00 €

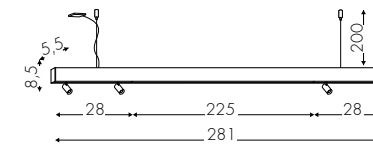

**1030H22OFBVE2B** Spot 4x7W 4x680lm  
70W 6020lm + 18W 2390lm - 220V

1.548,00 €

**1030H22DMBVE2B** DALI (Push) - Spot 4x7W 4x680lm  
70W 6020lm + 18W 2390lm - 220V

1.914,00 €

Configura

Configure / Konfigurieren

[www.teamitaliailluminazione.it](http://www.teamitaliailluminazione.it)



**CODICE COMPLETO DEL PRODOTTO NELLA FOTO**  
FULL PRODUCT CODE AS SHOWN IN PICTURE - VOLLSTÄNDIGER CODE VOM ARTIKEL IM BILD

**1030D11OF** **NE** **E2** **B**

Codice  
Code

Finitura  
Finishing  
Lackierung

Diffusore  
Diffuser  
Diffusor

Tonalità  
Hue  
Farbton

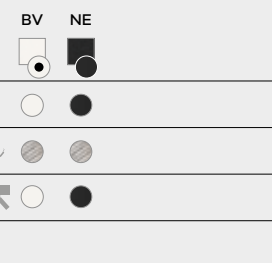

**A** Alimentatore Incorporato - Incorporated Power Supply - Eingebautes Netzteil

\*3761lm effettivi - effective - effektive con - with - mit E2

INDEX

SECTION

FAMILY 123



BF custom finish

configurazione standard: / basic configuration: / Standard Konfiguration:

E2 Opale - Opal - Opal ● B 3000K



**1082ATFBVE2B** 6,5W 680lm\* - 220V

**310,00 €**

[Configura](#) Configure / Konfigurieren

[www.teamitaliailluminazione.it](http://www.teamitaliailluminazione.it)

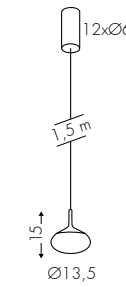

**1082GTFBVE2B** 4x6,5W 4x680lm - 220V

**980,00 €**

[Configura](#) Configure / Konfigurieren

[www.teamitaliailluminazione.it](http://www.teamitaliailluminazione.it)

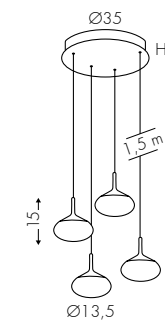

**1082HTFBVE2B** 6x6,5W 6x800lm - 220V

**1.750,00 €**

[Configura](#) Configure / Konfigurieren

[www.teamitaliailluminazione.it](http://www.teamitaliailluminazione.it)

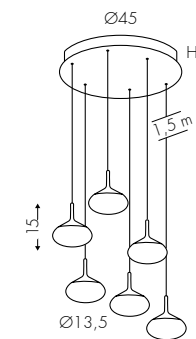

**CO05T2NE** Custom black cable

**8,00 € /MT**

[Configura](#) Configure / Konfigurieren

[www.teamitaliailluminazione.it](http://www.teamitaliailluminazione.it)



● A 2700K



**CODICE COMPLETO DEL PRODOTTO NELLA FOTO**  
FULL PRODUCT CODE AS SHOWN IN PICTURE - VOLLSTÄNDIGER CODE VOM ARTIKEL IM BILD

**1082HTF** **BF** **E2** **A**

Codice Code	Finitura Finishing Lackierung	Diffusore Diffuser Diffusor	Tonalità Hue Farbton
----------------	-------------------------------------	-----------------------------------	----------------------------

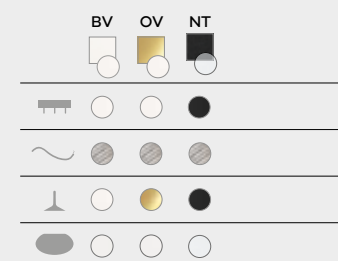

**TF** Taglio di Fase - Phase-Cut Dimmer - Phasenabschnittdimmer

**A** Alimentatore nel rosone - Power Supply inside the ceiling rose - Netzteil in der Deckendose

\* 680lm effettivi - effective - effektive con - with - mit **E2**





configurazione standard: / basic configuration: / Standard Konfiguration:

**E28** Satinato  
Frosted - Satiniert BV

**B** 3000K

**1009ATFBVE28B** 13W 1000lm\* - 220V 174,00 €

Configura Configure / Konfigurieren

[www.teamitaliailluminazione.it](http://www.teamitaliailluminazione.it)

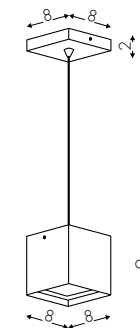

**1009BTFBVE28B** 26W 2000lm - 220V 325,00 €

Configura Configure / Konfigurieren

[www.teamitaliailluminazione.it](http://www.teamitaliailluminazione.it)



**CODICE COMPLETO DEL PRODOTTO NELLA FOTO**  
FULL PRODUCT CODE AS SHOWN IN PICTURE - VOLLSTÄNDIGER CODE VOM ARTIKEL IM BILD

**1009ATF** **NE** **E28** **B**

Codice Code	Finitura Finishing Lackierung	Diffusore Diffuser Diffusor	Tonalità Hue Farbton
----------------	-------------------------------------	-----------------------------------	----------------------------

BV	NE	RU
<input type="checkbox"/>	<input checked="" type="checkbox"/>	<input type="checkbox"/>
<input type="checkbox"/>	<input type="checkbox"/>	<input type="checkbox"/>
<input type="checkbox"/>	<input type="checkbox"/>	<input type="checkbox"/>
<input type="checkbox"/>	<input type="checkbox"/>	<input type="checkbox"/>

**TF** Taglio di Fase - Phase-Cut Dimmer - Phasenabschnittdimmer  
**A** Alimentatore Incorporato - Incorporated Power Supply - Eingebautes Netzteil

\* 1000lm effettivi - effective - effektive con - with - mit **E28**



configurazione standard: / basic configuration: / Standard Konfiguration:

E2 Opale - Opal - Opal  B 3000K

BV

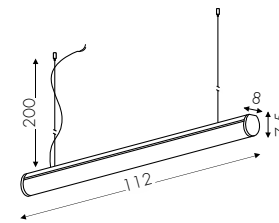

1065BBVE2B

25W 2856lm\* - 24VDC

242,00 €

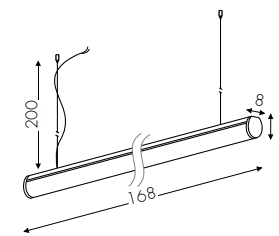

1065DBVE2B

37W 4290lm - 24VDC

276,00 €

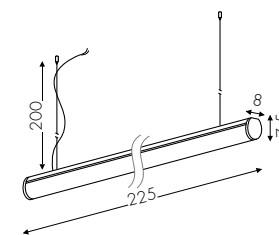

1065FBVE2B

50W 5738lm - 24VDC

321,00 €

Configura 

Configure / Konfigurieren

[www.teamitaliailluminazione.it](http://www.teamitaliailluminazione.it) 



A 2700K  C 4000K

NE

 CODICE COMPLETO DEL PRODOTTO NELLA FOTO  
FULL PRODUCT CODE AS SHOWN IN PICTURE - VOLLSTÄNDIGER CODE VOM ARTIKEL IM BILD

**1065D**

Codice  
Code

**NE**

Finitura  
Finishing  
Lackierung

**E2**

Diffusore  
Diffuser  
Diffusor

**B**

Tonalità  
Hue  
Farbton

BV

NE



 Alimentatore 24VDC non incluso - Not Included 24VDC Driver  
24VDC Netzteil nicht im Lieferumfang enthalten

**Alimentatori a pag.132 - Power Supply p.132 - Netzteil p.132**

\* 2856lm effettivi - effective - effektive con - with - mit E2





6500K

2700K

# OMNIA TUNABLE WHITE

SOSPENSIONE  
SUSPENSION LAMP  
PENDELLEUCHE



configurazione standard: / basic configuration: / Standard Konfiguration:

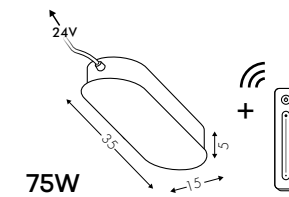

75W

**9065TWA**SDBV

75W - 220V (24VDC) + SMART DIM Tunable White

**212,00 €**

BV

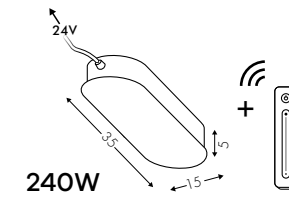

240W

**9065TWC**SDBV

240W - 220V (24VDC) + SMART DIM Tunable White

**307,00 €**

Configura Configure / Konfigurieren

[www.teamitaliailluminazione.it](http://www.teamitaliailluminazione.it)



**A**

NE

configurazione standard: / basic configuration: / Standard Konfiguration:

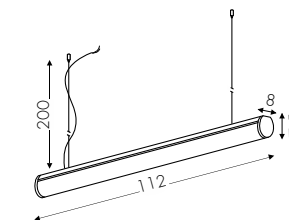

**E2** Opale - Opal - Opal

D 2700/6500K

BV

**1065TWB**BVE2D

32W 3600lm\* - 24VDC

**279,00 €**

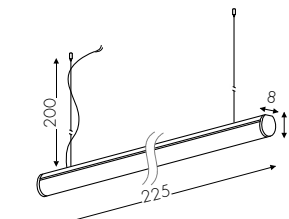

**1065TWF**BVE2D

60W 6750lm - 24VDC

**370,00 €**

Configura Configure / Konfigurieren

[www.teamitaliailluminazione.it](http://www.teamitaliailluminazione.it)



NE

**CODICE COMPLETO DEL PRODOTTO NELLA FOTO**  
FULL PRODUCT CODE AS SHOWN IN PICTURE - VOLLSTÄNDIGER CODE VOM ARTIKEL IM BILD

**1065TWB**

Codice  
Code

**BV**

Finitura  
Finishing  
Lackierung

**E2**

Diffusore  
Diffuser  
Diffusor

**D**

Tonalità  
Hue  
Farbton

BV  NE

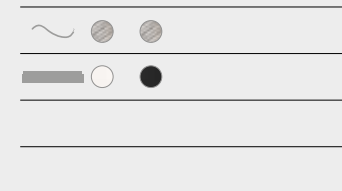

Alimentatore 24VDC non incluso - Not Included 24VDC Driver  
24VDC Netzteil nicht im Lieferumfang enthalten

**Alimentatori a pag.132 - Drivers p.132 - Netzteil p.132**

Alimentatore Incorporato - Incorporated Power Supply - Eingebautes Netzteil

\* 3600lm effettivi - effective - effektive con - with - mit **E2**



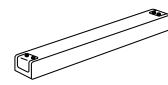

## 24V ON/OFF

<b>AE003A</b>	Driver 30W - On/Off 24V / IP20	<b>29,00 €</b>
<b>AE003B</b>	Driver 75W - On/Off 24V / IP20	<b>45,00 €</b>
<b>AE003C</b>	Driver 100W - On/Off 24V / IP65	<b>74,00 €</b>
<b>AE003D</b>	Driver 150W - On/Off 24V / IP65	<b>98,00 €</b>
<b>AE003E</b>	Driver 240W - On/Off 24V / IP65	<b>127,00 €</b>

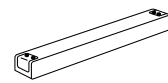

## 24V DALI

<b>AE004A</b>	Driver 150W - DALI (No-Push) 24V / IP65	<b>113,00 €</b>
---------------	---	-----------------

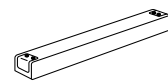

## 24V TRIAC

<b>AE005A</b>	Driver 100W - Triac 24V / IP20	<b>124,00 €</b>
<b>AE005B</b>	Driver 200W - Triac 24V / IP65	<b>198,00 €</b>

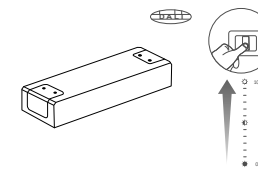

**90106002**

Dimmer: DALI(Push)/1-10V - max 240W-24VDC

**79,00 €**



**9010SMARTCW**

Dispositivo per la gestione di sorgenti led a luce calda/fredda con Radiocomando.  
Twin-white Led light remote control.  
Gerät für die Verwaltung von Led Quellen zum warm bis kalt Licht mit Fernsteuerung.

**86,00 €**



**9010SMARTMD**

Dispositivo per la gestione di sorgenti led a luce monocromatica con Radiocomando.  
Monochromatic light management with remote control.  
Gerät zur Verwaltung von monochromen LED-Lichtquellen mit Funkfernsteuerung.

**74,00 €**

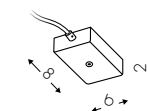

**AM002A**

Rosone (Solo collegamento elettrico rettangolo)  
Canopy (Only electrical connection rectangle)  
Xxx (Nur elektrische Verbindung Rechteck)

**28,00 €**

Configura

Configure / Konfigurieren

[www.teamitaliailluminazione.it](http://www.teamitaliailluminazione.it)



CODICE COMPLETO • COMPLETE CODE • KOMPLETT CODE

**AE003C**

Codice  
Code

CODICE COMPLETO • COMPLETE CODE • KOMPLETT CODE

**90106002**

Codice  
Code

# OVERLAP 2.0

SOSPENSIONE  
SUSPENSION LAMP  
PENDELLEUCHE



configurazione standard: / basic configuration: / Standard Konfiguration:

E2 Opale - Opal

B 3000K

BV

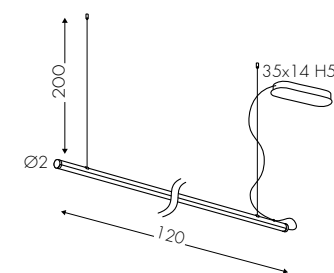

**1015COFBVE2B**  
**1015CDMBVE2B**

28W 1890lm\* - 220V  
DALI (Push) - 28W 1890lm - 220V

**363,00 €**  
**435,00 €**

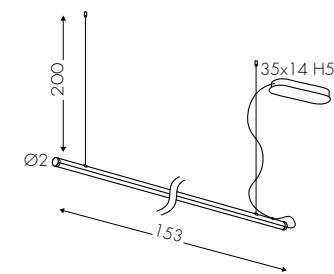

**1015DOFBVE2B**  
**1015DDMBVE2B**

35W 2350lm - 220V  
DALI (Push) - 35W 2350lm - 220V

**397,00 €**  
**470,00 €**

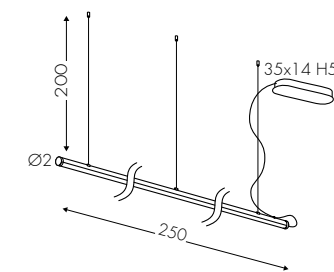

**1015EOFBE2B**  
**1015EDMBVE2B**

55W 3800lm - 220V  
DALI (Push) - 55W 3800lm - 220V

**492,00 €**  
**560,00 €**

C005T2NE

Custom black cable

**8,00 € /MT**

Configura

Configure / Konfigurieren

[www.teamitaliailluminazione.it](http://www.teamitaliailluminazione.it)



A 2700K



**CODICE COMPLETO DEL PRODOTTO NELLA FOTO**  
**FULL PRODUCT CODE AS SHOWN IN PICTURE - VOLLSTÄNDIGER CODE VOM ARTIKEL IM BILD**

**1015DOF** **RV** **E2** **B**

Codice  
Code

Finitura  
Finishing  
Lackierung

Diffusore  
Diffuser  
Diffusor

Tonalità  
Hue  
Farbton

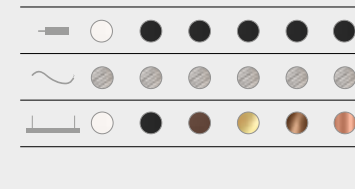

**A** Alimentatore nel rosone - Power Supply inside the ceiling rose - Netzteil in der Deckendose

\* 1890lm effettivi - effective - effektive con - with - mit **E2**

INDEX

SECTION

FAMILY 135

# OVERLAP DECÒ

SOSPENSIONE  
SUSPENSION LAMP  
PENDELLEUCHE



configurazione standard: / basic configuration: / Standard Konfiguration:

E2 Opale - Opal

B 3000K

BV

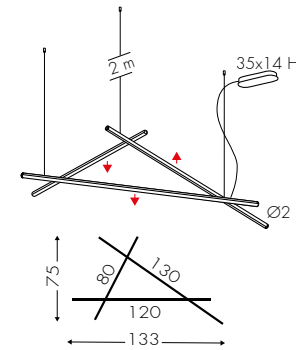

1015GTFBVE2B

up 29W 2100lm - down 46W 3400lm\* - 220V

780,00 €

1015GDMBVE2B

DALI (Push) - up 29W 2100lm - down 46W 3400lm\* - 220V

860,00 €

1015GSDBVE2B

up 29W 2100lm - down 46W 3400lm\* - 220V

860,00 €

Configura

Configure / Konfigurieren

[www.teamitaliailluminazione.it](http://www.teamitaliailluminazione.it)

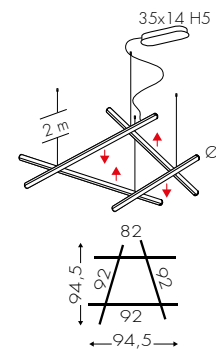

1015LTFBVE2B

up 40W 3000lm - down 38W 2900lm - 220V

780,00 €

1015LDMBVE2B

DALI (Push) - up 40W 3000lm - down 38W 2900lm - 220V

860,00 €

1015LSDBVE2B

up 40W 3000lm - down 38W 2900lm - 220V

860,00 €

Configura

Configure / Konfigurieren

[www.teamitaliailluminazione.it](http://www.teamitaliailluminazione.it)

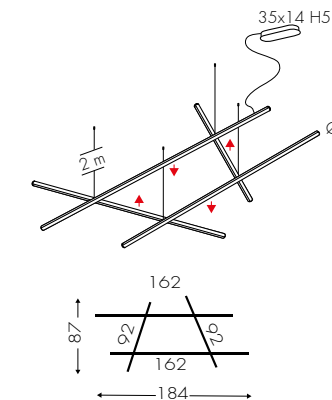

1015MTFBVE2B

up 40W 3100lm - down 70W 5400lm - 220V

890,00 €

1015MDMBVE2B

DALI (Push) - up 40W 3100lm - down 70W 5400lm - 220V up

970,00 €

1015MSDBVE2B

40W 3100lm - down 70W 5400lm - 220V

970,00 €

C005T2NE

Custom black cable

8,00 € /MT

Configura

Configure / Konfigurieren

[www.teamitaliailluminazione.it](http://www.teamitaliailluminazione.it)



A

A 2700K



CODICE COMPLETO DEL PRODOTTO NELLA FOTO  
FULL PRODUCT CODE AS SHOWN IN PICTURE - VOLLSTÄNDIGER CODE VOM ARTIKEL IM BILD

**1015MTF** **OV** **E2** **B**

Codice Code	Finitura Finishing Lackierung	Diffusore Diffuser Diffusor	Tonalità Hue Farbton
----------------	-------------------------------------	-----------------------------------	----------------------------

BV NE RU OV BR RV

A Alimentatore nel rosone - Power Supply inside the ceiling rose - Netzteil in der Deckendose

TF Taglio di Fase - Phase-Cut Dimmer - Phasenabschrittdimmer

SD Telecomando radio - Smart Dimmer - Smart Dimmer

\* 5500lm effettivi - effective - effektiven con - with - mit E2



# PLENI

SOSPENSIONE  
SUSPENSION LAMP  
PENDELLEUCHTE



configurazione standard: / basic configuration: / Standard Konfiguration:

E2 Opale - Opal

B 3000K

BV

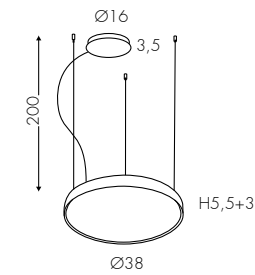

**1067BOFBVE2B**  
**1067BDMBVE2B**

26W 3586lm\* - 220V  
DALI (Push) - 26W 3586lm - 220V

**490,00 €**  
**610,00 €**

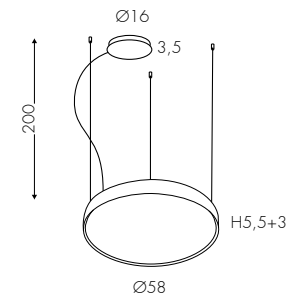

**1067DOFBVE2B**  
**1067DDMBVE2B**

47W 6500lm - 220V  
DALI (Push) - 47W 6500lm - 220V

**675,00 €**  
**775,00 €**

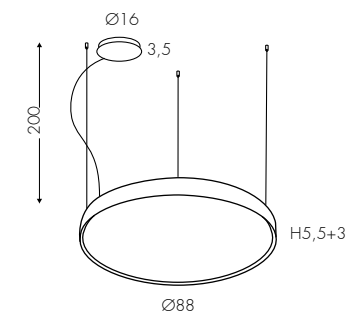

**1067FOFBVE2B**  
**1067FDMBVE2B**

70W 8220lm - 220V  
DALI (Push) - 70W 8220lm - 220V

**970,00 €**  
**1.070,00 €**

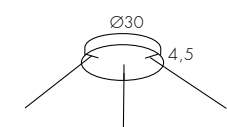

**VA003E**

Variatione: sostituzione con rosone centrale Ø30cm  
Variation: substitution with central ceiling rose Ø30cm  
Variante: Ersatz durch zentrale Deckenrose Ø30cm

**100,00 €**

Configura

Configure / Konfigurieren

[www.teamitaliailluminazione.it](http://www.teamitaliailluminazione.it)

C 4000K

E19 UGR<19 Prism

C 4000K

NE

**A** Alimentatore Incorporato - Incorporated Power Supply - Eingebautes Netzteil

\* 3586lm effettivi - effective - effektive con - with - mit **E2**  
4220lm effettivi - effective - effektive con - with - mit **E19** **+17,5%**

**CODICE COMPLETO DEL PRODOTTO NELLA FOTO**  
FULL PRODUCT CODE AS SHOWN IN PICTURE - VOLLSTÄNDIGER CODE VOM ARTIKEL IM BILD

**1067DOF** **NE** **E2** **B**

Codice  
Code

Finitura  
Finishing  
Lackierung

Diffusore  
Diffuser  
Diffusor

Tonalità  
Hue  
Farbton

BV

NE

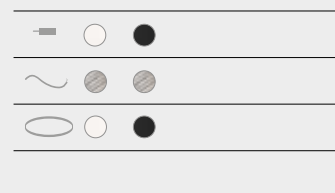

INDEX

SECTION

FAMILY 139

# RIFLESSA

SOSPENSIONE  
SUSPENSION LAMP  
PENDELLEUCHE



configurazione standard: / basic configuration: / Standard Konfiguration:

E28 Satinato  
Frosted - Satinert

B 3000K

BV

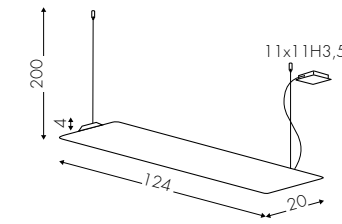

**1052BOFBVE28B**  
**1052BDMBVE28B**  
**1052BTBVE28B**

36W 4050lm\* - 220V  
DALI (Push) - 36W 4050lm - 220V  
Bluetooth - 36W 4050lm - 220V

**577,00 €**  
**647,00 €**  
**775,00 €**

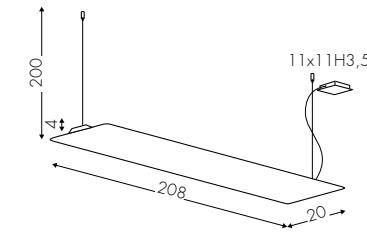

**1052EOFVE28B**  
**1052EDMBVE28B**  
**1052EBTVE28B**

63W 7050lm - 220V  
DALI (Push) - 63W 7050lm - 220V  
Bluetooth - 63W 7050lm - 220V

**675,00 €**  
**753,00 €**  
**881,00 €**

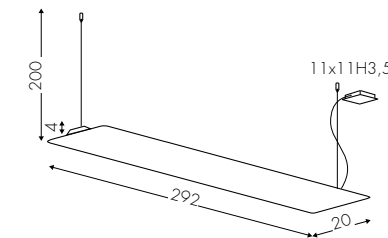

**1052HOFVE28B**  
**1052HDMBVE28B**  
**1052HBTVE28B**

90W 10100lm - 220V  
DALI (Push) - 90W 10100lm - 220V  
Bluetooth - 90W 10100lm - 220V

**876,00 €**  
**982,00 €**  
**1.109,00 €**

Configura

Configure / Konfigurieren

[www.teamitaliailluminazione.it](http://www.teamitaliailluminazione.it)



A 2700K



BV  NE  RU  OV  BR  RV

**BT** Bluetooth - Bluetooth - Bluetooth

**A** Alimentatore Incorporato - Incorporated Power Supply - Eingebautes Netzteil

\* 4050lm effettivi - effective - effektive con - with - mit **E28**

INDEX

SECTION

FAMILY 141



# RIFLESSA UPLIGHT + DARKLIGHT

SOSPENSIONE  
SUSPENSION LAMP  
PENDELLEUCHE



configurazione standard: / basic configuration: / Standard Konfiguration:

E28 Satinato - Frosted - Satinert  
55° Ottica - Optic - Optik

B 3000K

BV

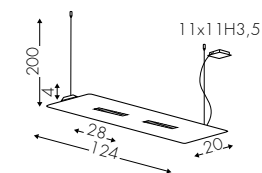

**1053BOFBV55B**  
**1053BDMBV55B**  
**1053BBTBV55B**

up 36W 4050lm\* + down 15W 2000lm - 220V  
DALI (Push) - up 36W 4050lm + down 15W 2000lm - 220V  
Bluetooth - up 36W 4050lm + down 15W 2000lm - 220V

**682,00 €**  
**814,00 €**  
**948,00 €**

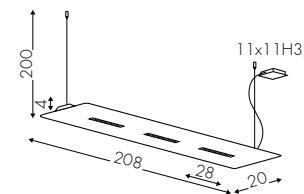

**1053EOFBV55B**  
**1053EDMBV55B**  
**1053EBTBV55B**

up 63W 7050lm + down 22W 3000lm - 220V  
DALI (Push) - up 63W 7050lm + down 22W 3000lm - 220V  
Bluetooth - up 63W 7050lm + down 22W 3000lm - 220V

**877,00 €**  
**970,00 €**  
**1.104,00 €**

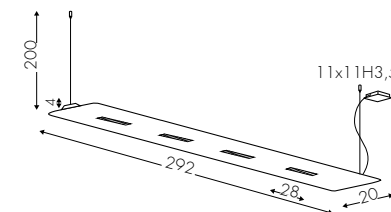

**1053HOFBV55B**  
**1053HDMBV55B**  
**1053HBTBV55B**

up 90W 10100lm + down 30W 4000lm - 220V  
DALI (Push) - up 90W 10100lm + down 30W 4000lm - 220V  
Bluetooth - up 90W 10100lm + down 30W 4000lm - 220V

**1.158,00 €**  
**1.337,00 €**  
**1.471,00 €**

Configura Configura / Konfigurieren

[www.teamitaliailluminazione.it](http://www.teamitaliailluminazione.it)



A 2700K



**CODICE COMPLETO DEL PRODOTTO NELLA FOTO**  
FULL PRODUCT CODE AS SHOWN IN PICTURE - VOLLSTÄNDIGER CODE VOM ARTIKEL IM BILD

**1053EOF** **BR** **55** **A**

Codice Code  
Finitura Finishing Lackierung  
Diffusore Diffuser Diffusor  
Tonalità Hue Farbton

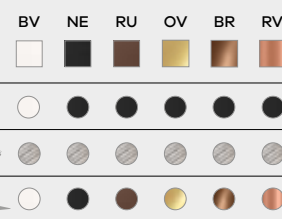

**BT** Bluetooth - Bluetooth - Bluetooth  
**A** Alimentatore Incorporato - Incorporated Power Supply - Eingebautes Netzteil

\* 4050lm effettivi - effective - effektive con - with - mit **E28**

INDEX

SECTION

FAMILY 143



# RIFLESSA

SOSPENSIONE  
SUSPENSION LAMP  
PENDELLEUCHE



configurazione standard: / basic configuration: / Standard Konfiguration:

E28 Satinato - Frosted - Satinert  
24° Ottica - Optic - Optik

**B** 3000K

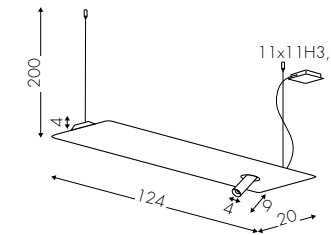

**1054BOFBV24B**  
**1054BDMBV24B**  
**1054BBTBV24B**

36W 4050lm\* + 1x7W 1x680lm - 220V  
DALI (Push) - 36W 4050lm + 1x7W 1x680lm - 220V  
Bluetooth - 36W 4050lm + 1x7W 1x680lm - 220V

**701,00 €**  
**797,00 €**  
**923,00 €**

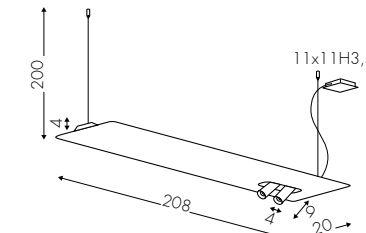

**1054EOFBV24B**  
**1054EDMBV24B**  
**1054EBTBV24B**

63W 7050lm + 2x7W 2x680lm - 220V  
DALI (Push) - 63W 7050lm + 2x7W 2x680lm - 220V  
Bluetooth - 63W 7050lm + 2x7W 2x680lm - 220V

**804,00 €**  
**934,00 €**  
**1.061,00 €**

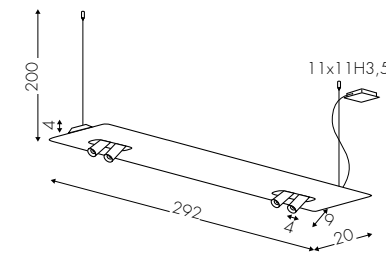

**1054HOFBV24B**  
**1054HDMBV24B**  
**1054HBTBV24B**

90W 10100lm + 4x7W 4x680lm - 220V  
DALI (Push) - 90W 10100lm + 4x7W 4x680lm - 220V  
Bluetooth - 90W 10100lm + 4x7W 4x680lm - 220V

**1.236,00 €**  
**1.348,00 €**  
**1.475,00 €**



Configura Configure / Konfigurieren

[www.teamitaliailluminazione.it](http://www.teamitaliailluminazione.it)

**A** 2700K



**CODICE COMPLETO DEL PRODOTTO NELLA FOTO**  
FULL PRODUCT CODE AS SHOWN IN PICTURE - VOLLSTÄNDIGER CODE VOM ARTIKEL IM BILD

**1054EOF** **ON** **24** **A**

Codice Code  
Finitura Finishing Lackierung  
Diffusore Diffuser Diffusor  
Tonalità Hue Farbton

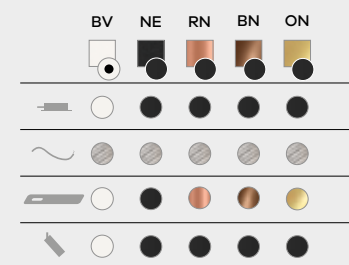

**BT** Bluetooth - Bluetooth - Bluetooth  
**A** Alimentatore Incorporato - Incorporated Power Supply - Eingebautes Netzteil

\* 4050lm effettivi - effective - effektive con - with - mit **E28**

INDEX

SECTION

FAMILY 145



# SAMPLING VENIS/LAMBDA/LICIS

SOSPENSIONE (composizione)  
SUSPENSION (composition)  
SUSPENSION (composition)



configurazione standard: / basic configuration: / Standard Konfiguration:

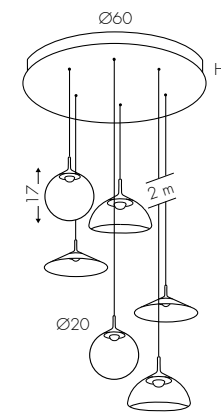

E19 Prismatico - Prism  
E2 Opale - Opal - Opal

B 3000K

A1

1080ATFA1B

6x6,5W 6x800lm - 220V

1.850,00 €

2X



ON Oro + Nero  
Gold + Black  
Gold + Schwarz  
E19 Prismatico - Prism



2X



NF Nero + vetro fumè  
Black + fumè glass  
Schwarz + Rauchglaselement  
E2 Opale - Opal - Opal



2X



NZ Nero + vetro bronzo  
Black + bronze glass  
Schwarz + Bronze Glas.  
E2 Opale - Opal - Opal



CO05T2NE

Custom black cable

8,00 € /MT

Configura



Configure / Konfigurieren

[www.teamitaliailluminazione.it](http://www.teamitaliailluminazione.it)



A

A 2700K

**CODICE COMPLETO DEL PRODOTTO NELLA FOTO**  
FULL PRODUCT CODE AS SHOWN IN PICTURE - VOLLSTÄNDIGER CODE VOM ARTIKEL IM BILD

**1080ATF** **A1** **A**

Codice  
Code

Finitura  
Finishing  
Lackierung

Tonalità  
Hue  
Farbton

# SHADOW

SOSPENSIONE  
SUSPENSION LAMP  
PENDELLEUCHTE



configurazione standard: / basic configuration: / Standard Konfiguration:

E2 Opale - Opal - Opal ● B 3000K

BV

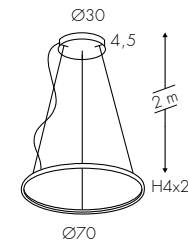

**1068BTFBVE2B**  
**1068BDMBVE2B**

49W 3440lm\* - 220V  
DALI (Push) - 49W 3340lm - 220V

**595,00 €**  
**670,00 €**

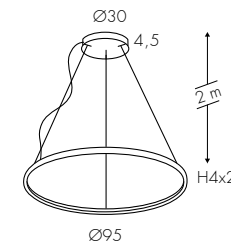

**1068CTFBVE2B**  
**1068CDMBVE2B**

66W 5630lm - 220V  
DALI (Push) - 66W 5630lm - 220V

**695,00 €**  
**788,00 €**

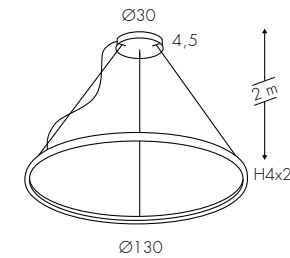

**1068DTFBVE2B**  
**1068DDMBVE2B**

90W 11860lm - 220V  
DALI (Push) - 90W 11860lm - 220V

**835,00 €**  
**935,00 €**



**VA004A**

Variatione: sostituzione con rosone decentrato  
Variation: substitution with decentralized ceiling rose  
Variante: ersatz durch dezentral deckenrose

**88,00 €**

**CO05T2NE**

Custom black cable

**8,00 € /MT**

Configura

Configure / Konfigurieren

[www.teamitaliailluminazione.it](http://www.teamitaliailluminazione.it)



● A 2700K



BV NE RV BR OV

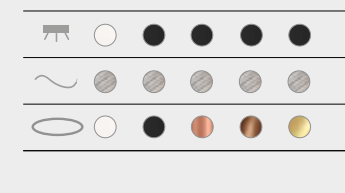

**A** Alimentatore nel rosone - Power Supply inside the ceiling rose - Netzteil in der Deckendose  
**TF** Taglio di Fase - Phase-Cut Dimmer - Phasenabschrittdimmer

\* 3440lm effettivi - effective - effektiven con - with - mit **E2**

INDEX

SECTION

FAMILY 149

**CODICE COMPLETO DEL PRODOTTO NELLA FOTO**  
FULL PRODUCT CODE AS SHOWN IN PICTURE - VOLLSTÄNDIGER CODE VOM ARTIKEL IM BILD

**1068CTF** **RV** **E2** **B**

Codice Code  
Finitura Finishing  
Diffusore Diffuser  
Tonalità Hue

Lackierung  
Diffusor  
Farbton



# SHADOW

SOSPENSIONE (composizione)  
SUSPENSION (composition)  
SUSPENSION (composition)



configurazione standard: / basic configuration: / Standard Konfiguration:

E2 Opale - Opal - Opal ● B 3000K

BV

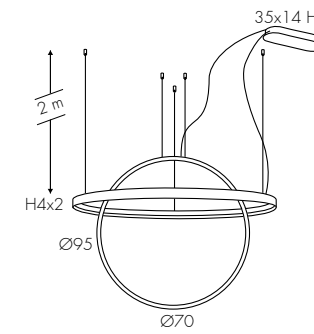

**1068CHTFBVE2B**  
**1068CHDMBVE2B**

66W 5630lm\* + 49W 3440lm 220V  
DALI (Push) - 66W 5630lm + 49W 3440lm 220V

**1.200,00 €**  
**1.370,00 €**

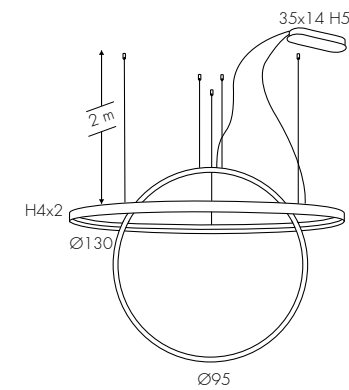

**1068DITFBVE2B**  
**1068DIDMBVE2B**

90W 7750lm + 66W 3680lm 220V  
DALI (Push) - 90W 7750lm + 66W 3680lm 220V

**1.442,00 €**  
**1.635,00 €**

● C005T2NE Custom black cable

**8,00 € /MT**

Configura Configure / Konfigurieren

[www.teamitaliailluminazione.it](http://www.teamitaliailluminazione.it)



● A 2700K



**CODICE COMPLETO DEL PRODOTTO NELLA FOTO**  
FULL PRODUCT CODE AS SHOWN IN PICTURE - VOLLSTÄNDIGER CODE VOM ARTIKEL IM BILD

**1068DITF** **OV** **E2** **B**

Codice Code	Finitura Finishing Lackierung	Diffusore Diffuser Diffusor	Tonalità Hue Farbton
----------------	-------------------------------------	-----------------------------------	----------------------------

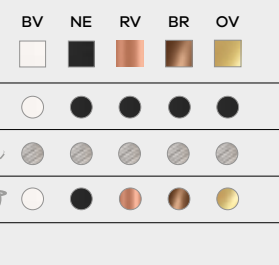

**A** Alimentatore nel rosone - Power Supply inside the ceiling rose - Netzteil in der Deckendose  
**TF** Taglio di Fase - Phase-Cut Dimmer - Phasenabschrittdimmer

\* 5630lm effettivi - effective - effektive con - with - mit **E2**

INDEX

SECTION

FAMILY 151



# SHAPE

SOSPENSIONE  
SUSPENSION LAMP  
PENDELLEUCHTE



configurazione standard: / basic configuration: / Standard Konfiguration:

E2 Opale - Opal ● B 3000K BV

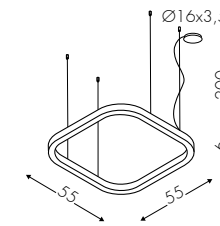

**1031AOFBVE2B**  
**1031ADMBVE2B**

52W 4510lm\* + 18W 2200lm - 220V  
DALI (Push) - 52W 4510lm + 18W 2200lm - 220V

**855,00 €**  
**936,00 €**

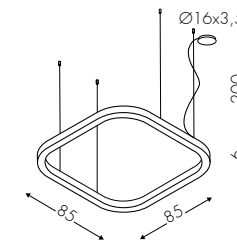

**1031BOFBVE2B**  
**1031BDMBVE2B**

83W 6800lm + 20W 2300lm - 220V  
DALI (Push) - 83W 6800lm + 20W 2300lm - 220V

**1.493,00 €**  
**1.604,00 €**

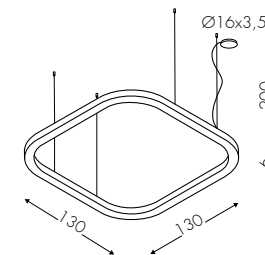

**1031COFBVE2B**  
**1031CDMBVE2B**

114W 9270lm + 30W 3861lm - 220V  
DALI (Push) - 114W 9270lm + 30W 3861lm - 220V

**1.926,00 €**  
**2.062,00 €**

Configura Configure / Konfigurieren

[www.teamitaliailluminazione.it](http://www.teamitaliailluminazione.it)



E19 UGR<19 Prism ● A 2700K ○ C 4000K

NE RU

**CODICE COMPLETO DEL PRODOTTO NELLA FOTO**  
FULL PRODUCT CODE AS SHOWN IN PICTURE - VOLLSTÄNDIGER CODE VOM ARTIKEL IM BILD

**1031BOF** **NE** **E2** **B**

Codice Code	Finitura Finishing Lackierung	Diffusore Diffuser Diffusor	Tonalità Hue Farbton
----------------	-------------------------------------	-----------------------------------	----------------------------

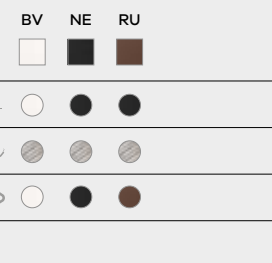

**A** Alimentatore Incorporato - Incorporated Power Supply - Eingebautes Netzteil

\* 4510lm effettivi - effective - effektive con - with - mit **E2**  
5300lm effettivi - effective - effektive con - with - mit **E19** ↻ +17,5%

INDEX

SECTION

FAMILY 153



# SHAPE

SOSPENSIONE  
SUSPENSION LAMP  
PENDELLEUCHE



BR custom finish

configurazione standard: / basic configuration: / Standard Konfiguration:

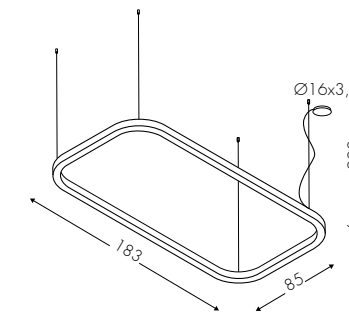

E2 Opale - Opal

B 3000K

BV



**1031DOFBVE2B**

105W 9780lm\* + 25W 3100lm - 220V

**2.026,00 €**

**1031DDMBVE2B**

DALI (Push) 105W 9780lm + 25W 3100lm - 220V

**2.206,00 €**

Configura

Configure / Konfigurieren

[www.teamitaliailluminazione.it](http://www.teamitaliailluminazione.it)



E19 UGR<19 Prism

A 2700K

C 4000K

NE RU



**CODICE COMPLETO DEL PRODOTTO NELLA FOTO**  
FULL PRODUCT CODE AS SHOWN IN PICTURE - VOLLSTÄNDIGER CODE VOM ARTIKEL IM BILD

**1031DOF**

**BR**

**E2**

**C**

Codice  
Code

Finitura  
Finishing  
Lackierung

Diffusore  
Diffuser  
Diffusor

Tonalità  
Hue  
Farbton

BV NE RU



**A** Alimentatore Incorporato - Incorporated Power Supply - Eingebautes Netzteil

\* 9780lm effettivi - effective - effektive con - with - mit **E2**  
11.500lm effettivi - effective - effektive con - with - mit **E19** **+17,5%**

INDEX

SECTION

FAMILY 155



# S-POT

SOSPENSIONE  
SUSPENSION LAMP  
PENDELLEUCHTE



configurazione standard: / basic configuration: / Standard Konfiguration:

BV



GU10

1018COFBV

1x GU10 max 7W LED - 220V

75,00 €

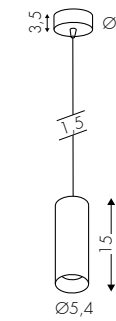

1018DOFBV

1x GU10 max 7W LED - 220V

91,00 €

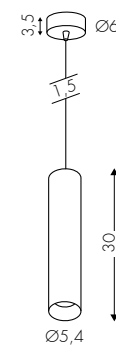

1018EOFBV

1x GU10 max 7W LED - 220V

117,00 €

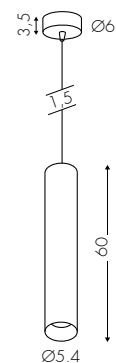

CO05T2NE

Custom black cable

8,00 € /MT

Configura



Configure / Konfigurieren

[www.teamitaliailluminazione.it](http://www.teamitaliailluminazione.it)



NE RV BR OV



**CODICE COMPLETO DEL PRODOTTO NELLA FOTO**  
FULL PRODUCT CODE AS SHOWN IN PICTURE - VOLLSTÄNDIGER CODE VOM ARTIKEL IM BILD

**1018COF**

Codice  
Code

**NE**

Finitura  
Finishing  
Lackierung

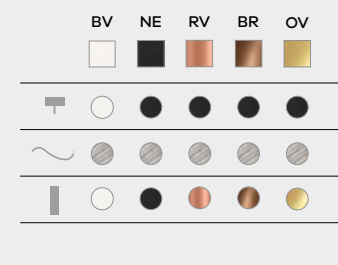

GU10 Sorgente GU10 non inclusa - GU10 light source not included - GU10 Lichtquelle nicht enthalten

INDEX

SECTION

FAMILY 157

# S-POT

SOSPENSIONE  
SUSPENSION LAMP  
PENDELLEUCHE



configurazione standard: / basic configuration: / Standard Konfiguration:

**E28** Satinato  
Frosted - Satiniert

B 3000K

BV



**1018ATFBVE28B**

17W 1500lm\* - 220V

**203,00 €**

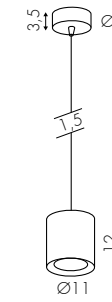

Configura

Configure / Konfigurieren

[www.teamitaliailluminazione.it](http://www.teamitaliailluminazione.it)



A 2700K  C 4000K

NE RU



configurazione standard: / basic configuration: / Standard Konfiguration:

**24°** Ottica - Optic - Optik

B 3000K

BV



**1018BOFBV24B**

26W 3400lm - 220V

**278,00 €**

**1018BDMBV24B**

DALI (Push) - 26W 3400lm - 220V

**347,00 €**

**1018BTFBV24B**

26W 3400lm - 220V

**323,00 €**

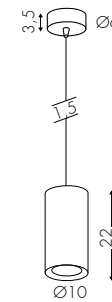

Configura

Configure / Konfigurieren

[www.teamitaliailluminazione.it](http://www.teamitaliailluminazione.it)



C 4000K

NE RU



**CODICE COMPLETO DEL PRODOTTO NELLA FOTO**  
FULL PRODUCT CODE AS SHOWN IN PICTURE - VOLLSTÄNDIGER CODE VOM ARTIKEL IM BILD

**1018BOF** **NE** **24** **B**

Codice  
Code

Finitura  
Finishing  
Lackierung

Diffusore  
Diffuser  
Diffusor

Tonalità  
Hue  
Farbton

BV NE RU



**TF** Taglio di Fase - Phase-Cut Dimmer - Erhältlich Phasenabschnittdimmer

**A** Alimentatore Incorporato - Incorporated Power Supply - Eingebautes Netzteil

\* 1500lm effettivi - effective - effektive con - with - mit **E28**



configurazione standard: / basic configuration: / Standard Konfiguration:

E8 Trasparente - Transparent ● B 3000K



1069IOFONE8B 3W 350lm\* - 220V

234,00 €

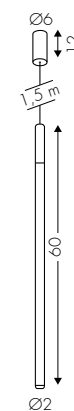

● C005T2NE Custom black cable

8,00 € /MT

Configura Configure / Konfigurieren

[www.teamitaliailluminazione.it](http://www.teamitaliailluminazione.it)



A E19 ● A 2700K



CODICE COMPLETO DEL PRODOTTO NELLA FOTO  
FULL PRODUCT CODE AS SHOWN IN PICTURE - VOLLSTÄNDIGER CODE VOM ARTIKEL IM BILD

**1069IOF** **ZN** **E8** **B**

Codice  
Code

Finitura  
Finishing  
Lackierung

Diffusore  
Diffuser  
Diffusor

Tonalità  
Hue  
Farbton



	ON	ZN	PN	BF
	●	●	●	●
	●	●	●	●
	●	●	●	●
	●	●	●	●

A Alimentatore nel rosone - Power Supply inside the ceiling rose - Netzteil in der Deckendose

\* 350lm effettivi - effective - effektive con - with - mit E8





# TUBICO

SOSPENSIONE  
SUSPENSION LAMP  
PENDELLEUCHE



configurazione standard: / basic configuration: / Standard Konfiguration:

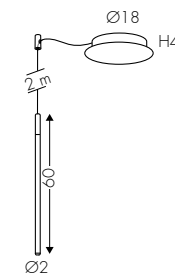

E8 Trasparente - Transparent ● B 3000K



**1069OOFONE8B** 3W 350lm\* - 220V

**248,00 €**

[Configura](#) Configure / Konfigurieren

[www.teamitaliailluminazione.it](http://www.teamitaliailluminazione.it)

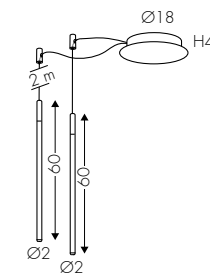

**1069PTFONE8B** 2x3W 2x350lm - 220V

**454,00 €**

[Configura](#) Configure / Konfigurieren

[www.teamitaliailluminazione.it](http://www.teamitaliailluminazione.it)

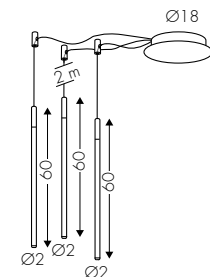

**1069MTFONE8B** 3x3W 3x350lm - 220V

**660,00 €**

**CO05T2NE** Custom black cable

**8,00 € /MT**

[Configura](#) Configure / Konfigurieren

[www.teamitaliailluminazione.it](http://www.teamitaliailluminazione.it)



A

E19 ● A 2700K

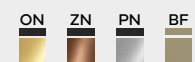
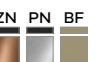

A Alimentatore nel rosone - Power Supply inside the ceiling rose - Netzteil in der Deckendose  
TF Taglio di Fase - Phase-Cut Dimmer - Phasenabschrittdimmer

\* 350lm effettivi - effective - effektive con - with - mit E8

optional

**CODICE COMPLETO DEL PRODOTTO NELLA FOTO**  
FULL PRODUCT CODE AS SHOWN IN PICTURE - VOLLSTÄNDIGER CODE VOM ARTIKEL IM BILD

**1069MTF PN E8 B**

Codice Code	Finitura Finishing Lackierung	Diffusore Diffuser Diffusor	Tonalità Hue Farbton
----------------	-------------------------------------	-----------------------------------	----------------------------

INDEX

SECTION

FAMILY 163



E19

# TUBICO

SOSPENSIONE (composizione)  
SUSPENSION (composition)  
SUSPENSION (composition)

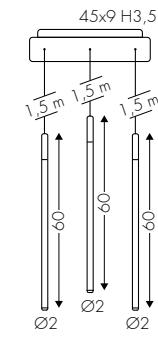

configurazione standard: / basic configuration: / Standard Konfiguration:

**E8** Trasparente - Transparent ● **B** 3000K



**1069LTFONE8B** 3x3W 3x350lm\* - 220V

**765,00 €**

Configura Configure / Konfigurieren

[www.teamitaliailluminazione.it](http://www.teamitaliailluminazione.it)

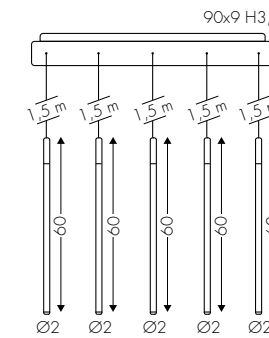

**1069QTFONE8B** 5x3W 5x350lm - 220V

**1.155,00 €**

Configura Configure / Konfigurieren

[www.teamitaliailluminazione.it](http://www.teamitaliailluminazione.it)

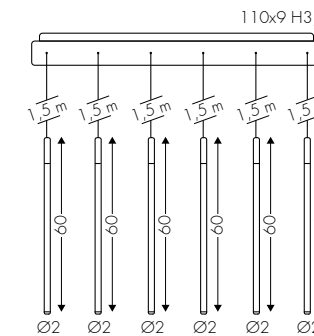

**1069RTFONE8B** 6x3W 6x350lm - 220V

**1.382,00 €**

**C005T2NE** Custom black cable

**8,00 € /MT**

Configura Configure / Konfigurieren

[www.teamitaliailluminazione.it](http://www.teamitaliailluminazione.it)



**A**

**E19** ● **A** 2700K

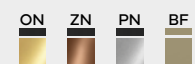
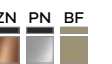

**A** Alimentatore nel rosone - Power Supply inside the ceiling rose - Netzteil in der Deckendose  
**TF** Taglio di Fase - Phase-Cut Dimmer - Phasenabschrittdimmer

\* 350lm effettivi - effective - effektive con - with - mit **E8**

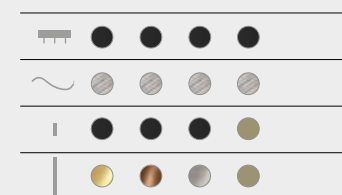

INDEX

SECTION

FAMILY 165

standard

**CODICE COMPLETO DEL PRODOTTO NELLA FOTO**  
FULL PRODUCT CODE AS SHOWN IN PICTURE - VOLLSTÄNDIGER CODE VOM ARTIKEL IM BILD

**1069LTF** **ON** **E8** **A**

Codice  
Code

Finitura  
Finishing  
Lackierung

Diffusore  
Diffuser  
Diffusor

Tonalità  
Hue  
Farbton

**E8**



custom mixed finish

configurazione standard: / basic configuration: / Standard Konfiguration:

E8 Trasparente - Transparent ● B 3000K



**1069NTFONE8B** 4x3W 4x350lm\* - 220V

**928,00 €**

Configura Configure / Konfigurieren

[www.teamitaliailluminazione.it](http://www.teamitaliailluminazione.it)

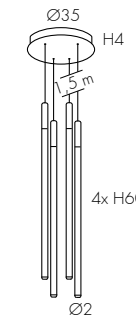

**1069STFONE8B** 6x3W 6x350lm - 220V

**1.327,00 €**

Configura Configure / Konfigurieren

[www.teamitaliailluminazione.it](http://www.teamitaliailluminazione.it)

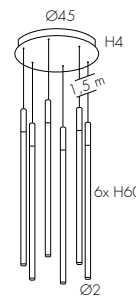

**1069TTFONE8B** 12x3W 12x350lm - 220V

**2.844,00 €**

**CO05T2NE** Custom black cable

**8,00 € /MT**

Configura Configure / Konfigurieren

[www.teamitaliailluminazione.it](http://www.teamitaliailluminazione.it)



**A** E19 ● A 2700K

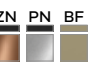

CODICE COMPLETO • COMPLETE CODE • VOLLSTÄNDIGE CODE

**1069TTF** **ON** **E8** **B**

Codice  
Code

Finitura  
Finishing  
Lackierung

Diffusore  
Diffuser  
Diffusor

Tonalità  
Hue  
Farbton

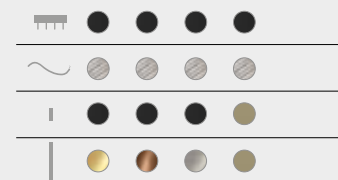
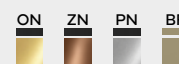

**A** Alimentatore nel rosone - Power Supply inside the ceiling rose - Netzteil in der Deckendose  
**TF** Taglio di Fase - Phase-Cut Dimmer - Phasenabschrittdimmer

\* 350lm effettivi - effective - effektive con - with - mit **E8**

standard



E8





# VELATA

SOSPENSIONE  
SUSPENSION LAMP  
PENDELLEUCHE



configurazione standard: / basic configuration: / Standard Konfiguration:

E28 Satinato  
Frosted - Satinert

● B 3000K

BV

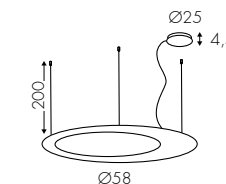

**1038AOFBVE28B**

25W 3700lm\* - 220V

**648,00 €**

**1038ADMBVE28B**

DALI (Push) - 25W 3700lm - 220V

**790,00 €**

**1038ATFBVE28B**

25W 3700lm - 220V

**790,00 €**

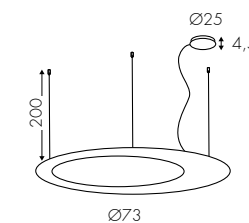

**1038BOFBVE28B**

50W 6400lm - 220V

**816,00 €**

**1038BDMBVE28B**

DALI (Push) - 50W 6400lm - 220V

**903,00 €**

**1038BTFBVE28B**

50W 6400lm - 220V

**903,00 €**

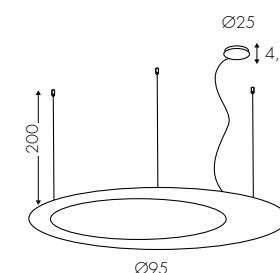

**1038COFBVE28B**

75W 7800lm - 220V

**1.047,00 €**

**1038CDMBVE28B**

DALI (Push) - 75W 7800lm - 220V

**1.164,00 €**

**1038CBTVE28B**

Bluetooth 75W 7800lm - 220V

**1.164,00 €**

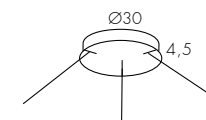

**VA003E**

Variazione: sostituzione con rosone centrale Ø30cm  
Variation: substitution with central ceiling rose Ø30cm  
Variante: Ersatz durch zentrale Deckenrose Ø30cm

**100,00 €**

Configura

Configure / Konfigurieren

[www.teamitaliailluminazione.it](http://www.teamitaliailluminazione.it)



● A 2700K



**CODICE COMPLETO DEL PRODOTTO NELLA FOTO**  
FULL PRODUCT CODE AS SHOWN IN PICTURE - VOLLSTÄNDIGER CODE VOM ARTIKEL IM BILD

**1038BOF** **NE** **E28** **B**

Codice  
Code

Finitura  
Finishing  
Lackierung

Diffusore  
Diffuser  
Diffusor

Tonalità  
Hue  
Farbton

BV NE RV BR OV

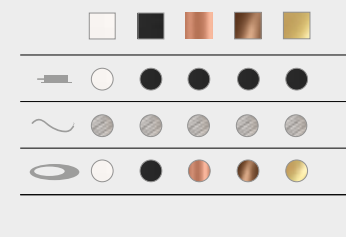

**TF** Taglio di Fase - Phase-Cut Dimmer - Phasenabschrittdimmer

**A** Alimentatore nel rosone - Power Supply inside the ceiling rose - Netzteil in der Deckendose

**BT** Bluetooth - Bluetooth - Bluetooth

\* 3700lm effettivi - effective - effektive con - with - mit **E28**

INDEX

SECTION

FAMILY 169



# VENIS

SOSPENSIONE  
SUSPENSION LAMP  
PENDELLEUCHE



configurazione standard: / basic configuration: / Standard Konfiguration:

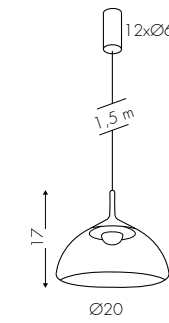

E2 Opale  
Opal - Opal

**B** 3000K



**1064ATF**NTE2B

6,5W 800lm\* - 220V

**350,00 €**

**C005T2NE**

Custom black cable

**8,00 € /MT**

Configura

Configure / Konfigurieren

[www.teamitaliailluminazione.it](http://www.teamitaliailluminazione.it)



A

**A** 2700K



**CODICE COMPLETO DEL PRODOTTO NELLA FOTO**  
FULL PRODUCT CODE AS SHOWN IN PICTURE - VOLLSTÄNDIGER CODE VOM ARTIKEL IM BILD

**1064ATF** **NT** **E2** **B** + **C005T2NE**

Codice  
Code

Finitura  
Finishing  
Lackierung

Diffusore  
Diffuser  
Diffusor

Tonalità  
Hue  
Farbton

Codice  
Code

custom BLACK CABLE

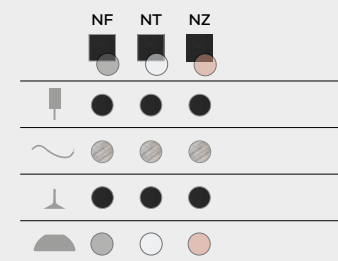

**A** Alimentatore nel rosone - Power Supply inside the ceiling rose - Netzteil in der Deckendose  
**TF** Taglio di Fase - Phase-Cut Dimmer - Phasenabschrittdimmer

\* 800lm effettivi - effective - effektive con - with - mit **E2**



# VENIS

SOSPENSIONE (composizione)  
SUSPENSION (composition)  
SUSPENSION (composition)



configurazione standard: / basic configuration: / Standard Konfiguration:

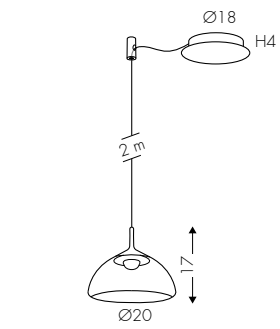

**E2** Opale  
Opal - Opal

**B** 3000K



**1064BTFNTE2B** 6,5W 800lm\* - 220V

**370,00 €**

Configura Configura / Konfigurieren

[www.teamitaliailluminazione.it](http://www.teamitaliailluminazione.it)

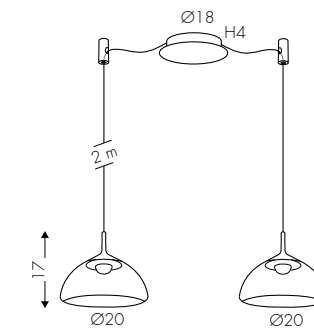

**1064CTFNTE2B** 2x6,5W 2x800lm - 220V

**590,00 €**

Configura Configura / Konfigurieren

[www.teamitaliailluminazione.it](http://www.teamitaliailluminazione.it)

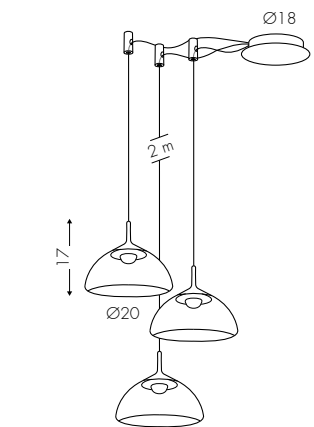

**1064DTFNTE2B** 3x6,5W 3x800lm - 220V

**795,00 €**

**C005T2NE** Custom black cable

**8,00 € /MT**

Configura Configura / Konfigurieren

[www.teamitaliailluminazione.it](http://www.teamitaliailluminazione.it)



**A** 2700K



**CODICE COMPLETO DEL PRODOTTO NELLA FOTO**  
FULL PRODUCT CODE AS SHOWN IN PICTURE - VOLLSTÄNDIGER CODE VOM ARTIKEL IM BILD

**1064CTF** **NT** **E2** **A**

Codice Code	Finitura Finishing Lackierung	Diffusore Diffuser Diffusor	Tonalità Hue Farbton
----------------	-------------------------------------	-----------------------------------	----------------------------

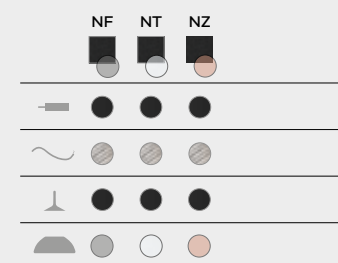

**A** Alimentatore nel rosone - Power Supply inside the ceiling rose - Netzteil in der Deckendose  
**TF** Taglio di Fase - Phase-Cut Dimmer - Phasenabschrittdimmer

\* 800lm effettivi - effective - effektiven con - with - mit **E2**

INDEX

SECTION

FAMILY 173





# VENIS

SOSPENSIONE (composizione)  
SUSPENSION (composition)  
SUSPENSION (composition)



configurazione standard: / basic configuration: / Standard Konfiguration:

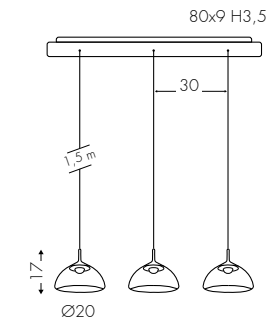

E2 Opale  
Opal - Opal

● B 3000K

NT

**1064ETFNTE2B**

3x6,5W 3x800lm\* - 220V

990,00 €

Configura

Configure / Konfigurieren

[www.teamitaliailluminazione.it](http://www.teamitaliailluminazione.it)

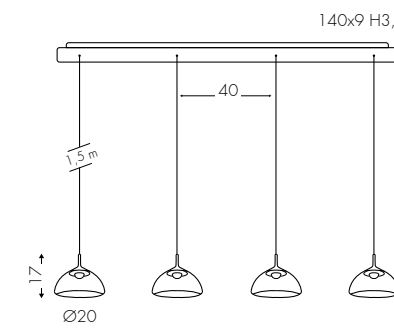

**1064FTFNT2B**

4x6,5W 4x800lm - 220V

1.350,00 €

● **CO05T2NE**

Custom black cable

8,00 € /MT

Configura

Configure / Konfigurieren

[www.teamitaliailluminazione.it](http://www.teamitaliailluminazione.it)



● A 2700K

NZ NF

**CODICE COMPLETO DEL PRODOTTO NELLA FOTO**  
FULL PRODUCT CODE AS SHOWN IN PICTURE - VOLLSTÄNDIGER CODE VOM ARTIKEL IM BILD

**1064FTF** **NZ** **E2** **A**

Codice Code	Finitura Finishing Lackierung	Diffusore Diffuser Diffusor	Tonalità Hue Farbton
----------------	-------------------------------------	-----------------------------------	----------------------------

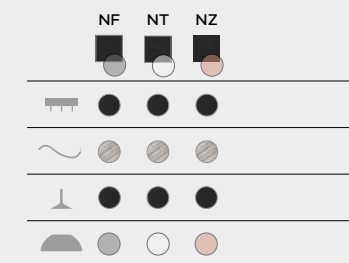

**A** Alimentatore nel rosone - Power Supply inside the ceiling rose - Netzteil in der Deckendose  
**TF** Taglio di Fase - Phase-Cut Dimmer - Phasenabschrittdimmer

\* 800lm effettivi - effective - effektiven con - with - mit **E2**



# VENIS

SOSPENSIONE (composizione)  
SUSPENSION (composition)  
SUSPENSION (composition)



configurazione standard: / basic configuration: / Standard Konfiguration:

E2 Opale  
Opal - Opal

B 3000K

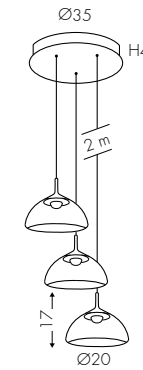

**1064GTFNTE2B**

3x6,5W 3x800lm\* - 220V

**1.100,00 €**

Configura

Configure / Konfigurieren

[www.teamitaliailluminazione.it](http://www.teamitaliailluminazione.it)

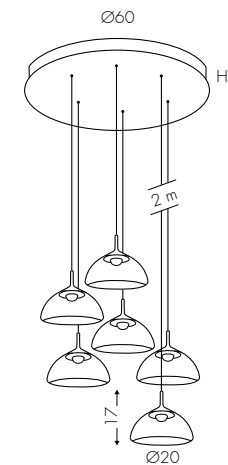

**1064HTFNTE2B**

6x6,5W 6x800lm - 220V

**1.950,00 €**

**CO05T2NE**

Custom black cable

**8,00 € /MT**

Configura

Configure / Konfigurieren

[www.teamitaliailluminazione.it](http://www.teamitaliailluminazione.it)



**A**

**A 2700K**



**CODICE COMPLETO DEL PRODOTTO NELLA FOTO**  
FULL PRODUCT CODE AS SHOWN IN PICTURE - VOLLSTÄNDIGER CODE VOM ARTIKEL IM BILD

**1064GTF NF E2 B**

Codice Code	Finitura Finishing Lackierung	Diffusore Diffuser Diffusor	Tonalità Hue Farbton
----------------	-------------------------------------	-----------------------------------	----------------------------

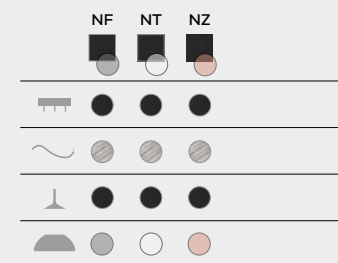

**A** Alimentatore nel rosone - Power Supply inside the ceiling rose - Netzteil in der Deckendose  
**TF** Taglio di Fase - Phase-Cut Dimmer - Phasenabschrittdimmer

\* 800lm effettivi - effective - effektiven con - with - mit **E2**

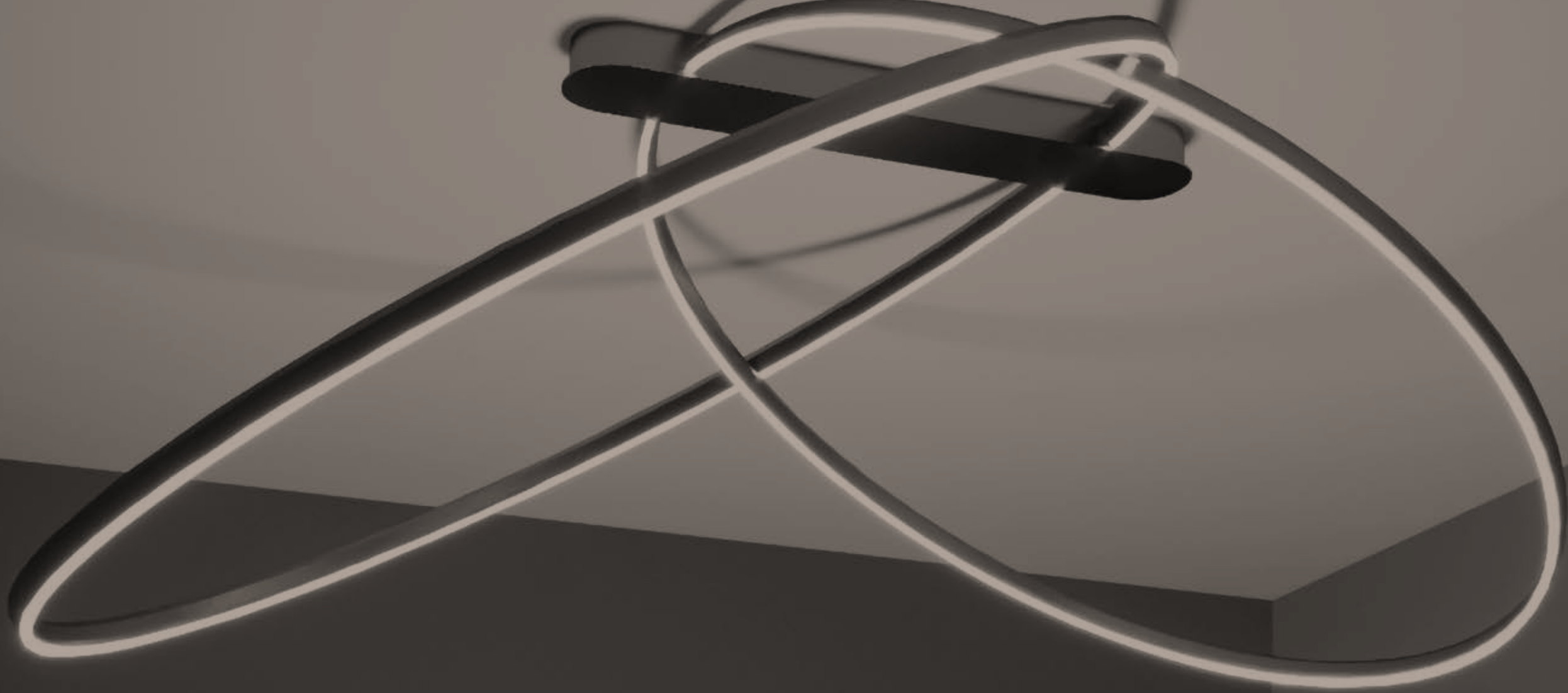

PLAFONE  
CEILING LIGHT  
DECKENLEUCHTE







**Bellai** 187  
downlight Ø70/Ø95



**Bellai** 189  
downlight Ø130/Ø180



**Bellai Home** 191  
downlight Ø58/Ø70/Ø95



**Bellai Home** 193  
up+downlight Ø58/Ø70/Ø95



**Overlap Decò** 235  
up+downlight 75x133

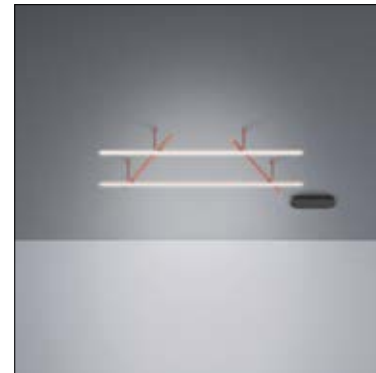

**Overlap Decò** 235  
up+downlight 94,5x94,5



**Overlap Decò** 235  
up+downlight 87x184



**Kasaa** 203  
downlight Ø20/Ø40/Ø55



**Chapeau** 195  
downlight Ø42



**Chapeau** 195  
downlight Ø60



**Compact** 197  
omni-light L10x10/L20x20



**Compact** 197  
omni-light L25x25/L40x40



**Compact** 197  
omni-light L40x10/L60x10



**Edge** 199  
downlight downlight 59x59/115x31



**Iglù** 201  
downlight Ø25/Ø40



**Leggera** 205  
downlight inclinato Ø65/Ø82



**Leggera** 207  
downlight composizione Ø45+Ø65/Ø65+Ø82



**Leggera** 209  
downlight L170



**Micro** 211  
orientabile 1x3W



**Micro** 211  
orientabile 2x3W



**Micro** 213  
orientabile + downlight 2x3W+15W



**Mirò Home** 215  
downlight + spotlight



**Operà** 219  
orientabile spotlight 1x7W



**Operà** 219  
orientabile spotlight 2x7W



**Operà** 219  
orientabile spotlight 3x7W



**Operà** 221  
orientabile + downlight 2x7W+25W



**Omnia** 217  
downlight L28/L56



**Omnia** 217  
downlight L112/L168/L225



**Oki** 223  
downlight L4x4 H7

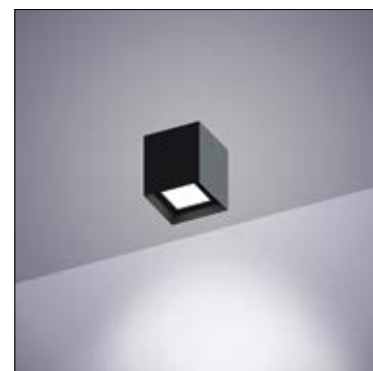

**Oki** 223  
downlight L8x8 H9



**Oki** 223  
downlight L15x15 H8



**Oki** 225  
downlight L15x15 H17



**Overlap** 233  
orientabile L90+L131/L90+L181



**Overlap** 233  
orientabile L90+2\*L181



**Oki** 227  
up+downlight L15x15 H20,5



**Oki** 229  
downlight L30x30



**Oki** 229  
downlight L55x55



**Oki** 229  
downlight L30x105



**Pleni** 237  
downlight Ø38/Ø58/Ø88



**Pleni** 237  
downlight Ø58/Ø88 Plafone staffa



**Oki** 231  
downlight doppio 2\*L8x8 H9



**Oki** 231  
downlight triplo 2\*L8x8 H9+L15x15 H8



**Shape** 239  
downlight L55x55/L85x85



**S-Pot Home** 241  
downlight Ø5,4 L15 / L30 - GU10



**S-Pot Home** 241  
downlight Ø5,4 L60 / L90 - GU10



**S-Pot** 243  
downlight Ø11 L12-17W/L22-26W



**S-Pot** 245  
downlight Ø18,5 - 26W



**Tablet Round** 247  
orientabile Ø9 1x7W



**Tablet Round** 247  
orientabile Ø9 2x7W



**Tablet Round** 247  
orientabile Ø32 3x7W



**Tablet Round** 249  
orientabile + downlight 2x7W+25W



**Tablet Round** 251  
orientabile 1x7W Ø9 GU10



**Tablet Round** 251  
orientabile 2x7W Ø9 GU10



**Tablet Square** 253  
orientabile L8x8 - 1x7W



**Tablet Square** 253  
orientabile 2x7W L8x16



**Tablet Square** 253  
orientabile 4x7W L28x28



**Tablet Square** 255  
orientabile L8x8 - 1x7W GU10



**Tablet Square** 255  
orientabile spotlight 2x7W GU10



**Task** 257  
downlight L4x12 H7 - 10W



**Task** 257  
downlight L8x8 H8 - 12W



**Velata** 259  
uplight Ø58/Ø73/Ø95



configurazione standard: / basic configuration: / Standard Konfiguration:

E2 Opale - Opal ● B 3000K

BV

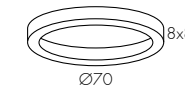

<b>3025AOFBVE2B</b>	50W 3810lm* - 220V	<b>1.006,00 €</b>
<b>3025ADMBVE2B</b>	DALI (Push) - 50W 3810lm - 220V	<b>1.139,00 €</b>
<b>3025AOFEMBVE2B</b>	50W 3810m - 220V	<b>1.194,00 €</b>

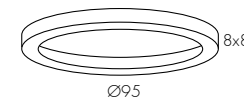

<b>3025BOFBVE2B</b>	65W 5170lm - 220V	<b>1.287,00 €</b>
<b>3025BDMBVE2B</b>	DALI (Push) - 65W 5170lm - 220V	<b>1.441,00 €</b>
<b>3025BOFEMBVE2B</b>	65W 5170lm - 220V	<b>1.475,00 €</b>

Configura Configure / Konfigurieren

[www.teamitaliailluminazione.it](http://www.teamitaliailluminazione.it)



E19 UGR<19 Prism ● A 2700K ○ C 4000K

NE RU

**↑** CODICE COMPLETO DEL PRODOTTO NELLA FOTO  
FULL PRODUCT CODE AS SHOWN IN PICTURE  
VOLLSTÄNDIGER CODE VOM ARTIKEL IM BILD

**3025BOF** **BV** **E2** **B**

Codice Code	Finitura Finishing Lackierung	Diffusore Diffuser Diffusor	Tonalità Hue Farbton
----------------	-------------------------------------	-----------------------------------	----------------------------

**EM** Emergenza - Emergency - Notbeleuchtung  
**A** Alimentatore Incorporato - Incorporated Power Supply - Eingebautes Netzteil

\* 3810lm effettivi - effective - effektive con - with - mit **E2**  
4480lm effettivi - effective - effektive con - with - mit **E19** ↻ +17,5%

configurazione standard: / basic configuration: / Standard Konfiguration:

E2 Opale - Opal

● B 3000K

BV

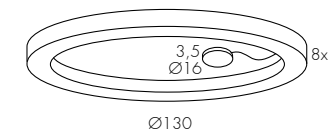

**3025COFBVE2B**

92W 7355lm\* - 220V

**2.122,00 €**

**3025CDMBVE2B**

DALI (Push) - 92W 7355lm - 220V

**2.296,00 €**

**3025COFEMBVE2B**

92W 7355lm - 220V

**2.313,00 €**

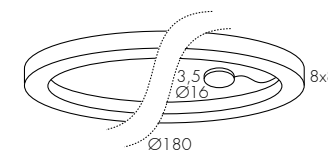

**3025DOFBVE2B**

160W 12950lm - 220V

**2.921,00 €**

**3025DDMBVE2B**

DALI (Push) - 160W 12950lm - 220V

**3.156,00 €**

**3025DOFEMBVE2B**

160W 12950lm - 220V

**3.125,00 €**

Configura 

Configure / Konfigurieren

[www.teamitaliailluminazione.it](http://www.teamitaliailluminazione.it) 



E19 UGR<19 Prism

● A 2700K ○ C 4000K

NE RU 

 **CODICE COMPLETO DEL PRODOTTO NELLA FOTO**  
FULL PRODUCT CODE AS SHOWN IN PICTURE - VOLLSTÄNDIGER CODE VOM ARTIKEL IM BILD

**3025COF** | **NE** | **E2** | **B**

Codice  
Code

Finitura  
Finishing  
Lackierung

Diffusore  
Diffuser  
Diffusor

Tonalità  
Hue  
Farbton

**EM** Emergenza - Emergency - Notbeleuchtung

**A** Alimentatore Incorporato - Incorporated Power Supply - Eingebautes Netzteil

\* 7355lm effettivi - effective - effektive con - with - mit **E2**  
8650lm effettivi - effective - effektive con - with - mit **E19**  **+17,5%**



configurazione standard: / basic configuration: / Standard Konfiguration:

E2 Opale - Opal

● B 3000K

BV

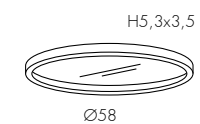

**3027EOFBVE2B**  
**3027EDMBVE2B**  
**3027ETFBVE2B**

45W 3230lm\* - 220V  
DALI (Push) - 45W 3230lm - 220V  
45W 3230lm - 220V

**692,00 €**  
**780,00 €**  
**780,00 €**

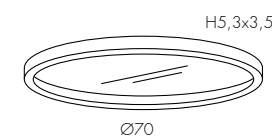

**3027COFBVE2B**  
**3027CDMBVE2B**  
**3027CBTBVE2B**

50W 3808lm - 220V  
DALI (Push) - 50W 3808lm - 220V  
Bluetooth 50W 3808lm - 220V

**803,00 €**  
**895,00 €**  
**895,00 €**

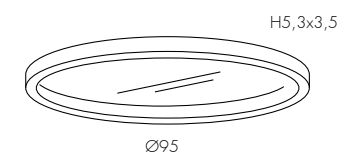

**3027FOFBVE2B**  
**3027FDMBVE2B**  
**3027FBTBVE2B**

65W 5168lm - 220V  
DALI (Push) - 65W 5168lm - 220V  
Bluetooth 65W 5168lm - 220V

**1.014,00 €**  
**1.103,00 €**  
**1.103,00 €**

Configura

Configure / Konfigurieren

[www.teamitaliailluminazione.it](http://www.teamitaliailluminazione.it)



E19 UGR<19 Prism

● A 2700K

NE RU

**CODICE COMPLETO DEL PRODOTTO NELLA FOTO**  
FULL PRODUCT CODE AS SHOWN IN PICTURE - VOLLSTÄNDIGER CODE VOM ARTIKEL IM BILD

**3027COF** **BV** **E2** **B**

Codice  
Code

Finitura  
Finishing  
Lackierung

Diffusore  
Diffuser  
Diffusor

Tonalità  
Hue  
Farbton

**TF** Taglio di Fase - Phase-Cut Dimmer - Phasenabschnittdimmer

**A** Alimentatore Incorporato - Incorporated Power Supply - Eingebautes Netzteil

**BT** Bluetooth - Bluetooth - Bluetooth

\* 3230lm effettivi - effective - effektive con - with - mit **E2**  
3800lm effettivi - effective - effektive con - with - mit **E19** **+17,5%**

INDEX

SECTION

FAMILY 191





configurazione standard: / basic configuration: / Standard Konfiguration:

E2 Opale - Opal

● B 3000K

BV

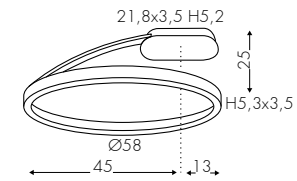

**3027DOFBVE2B**  
**3027DDMBVE2B**  
**3027DTFBVE2B**

42W 3247lm\* + 15.4W 1300lm - 220V  
DALI (Push) 42W 3247lm + 15.4W 1300lm - 220V  
42W 3247lm + 15.4W 1300lm - 220V

**705,00 €**  
**754,00 €**  
**754,00 €**

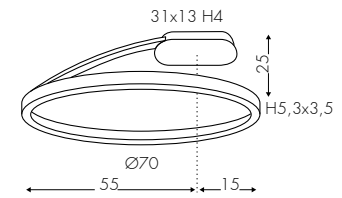

**3027AOFBVE2B**  
**3027ADMBVE2B**  
**3027ABTBVE2B**

50W 3808lm + 24W 2400lm - 220V  
DALI (Push) - 50W 3808lm + 24W 2400lm - 220V  
Bluetooth 50W 3808lm + 24W 2400lm - 220V

**818,00 €**  
**906,00 €**  
**906,00 €**

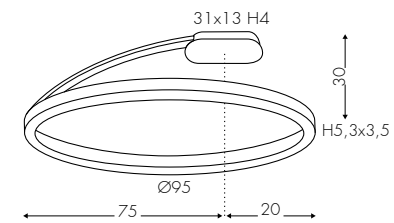

**3027BOFBVE2B**  
**3027BDMBVE2B**  
**3027BBTBVE2B**

65W 5168lm + 24W 2400lm - 220V  
DALI (Push) - 65W 5168lm + 24W 2400lm - 220V  
Bluetooth 65W 5168lm + 24W 2400lm - 220V

**937,00 €**  
**1.029,00 €**  
**1.029,00 €**

Configura

Configure / Konfigurieren

[www.teamitaliailluminazione.it](http://www.teamitaliailluminazione.it)



**A** E19 UGR<19 Prism

● A 2700K

NE RU

**CODICE COMPLETO DEL PRODOTTO NELLA FOTO**  
FULL PRODUCT CODE AS SHOWN IN PICTURE - VOLLSTÄNDIGER CODE VOM ARTIKEL IM BILD

**3027BOF** **NE** **E2** **B**

Codice  
Code

Finitura  
Finishing  
Lackierung

Diffusore  
Diffuser  
Diffusor

Tonalità  
Hue  
Farbton

**TF** Taglio di Fase - Phase-Cut Dimmer - Phasenabschnittdimmer

**A** Alimentatore nel rosone - Power Supply inside the ceiling rose - Netzteil in der Deckendose

**BT** Bluetooth - Bluetooth - Bluetooth

\* 3247lm effettivi - effective - effektive con - with - mit **E2**  
3815lm effettivi - effective - effektive con - with - mit **E19** ↻ +17,5%



configurazione standard: / basic configuration: / Standard Konfiguration:

E2 Opale - Opal

 B 3000K

BV

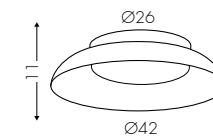

**3087BTFBVE2B**

18W 1620lm\* - 220V

**370,00 €**

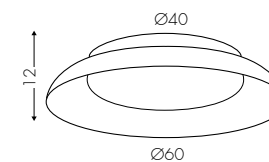

**3087DTFBVE2B**

30W 3000lm - 220V

**495,00 €**

Configura 

Configure / Konfigurieren

[www.teamitaliailluminazione.it](http://www.teamitaliailluminazione.it) 



 **CODICE COMPLETO DEL PRODOTTO NELLA FOTO**  
FULL PRODUCT CODE AS SHOWN IN PICTURE - VOLLSTÄNDIGER CODE VOM ARTIKEL IM BILD

**3087DTF** **OV** **E2** **B**

Codice  
Code

Finitura  
Finishing  
Lackierung

Diffusore  
Diffuser  
Diffusor

Tonalità  
Hue  
Farbton

**TF** Taglio di Fase - Phase-Cut Dimmer - Phasenabschnittdimmer

**A** Alimentatore Incorporato - Incorporated Power Supply - Eingebautes Netzteil

\* 1620lm effettivi - effective - effektiven con - with - mit **E2**



configurazione standard: / basic configuration: / Standard Konfiguration:

E2 Opale - Opal

BV

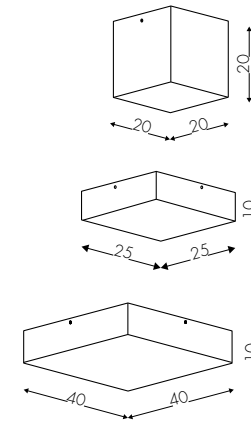

**E321BVE2** 1x E27 max 70W ES / 10W LED - 220V **262,00 €**

[Configura](#) Configure / Konfigurieren [www.teamitaliailluminazione.it](http://www.teamitaliailluminazione.it)

**E322BVE2** 2x E27 max 42W ES / 10W LED - 220V **262,00 €**

[Configura](#) Configure / Konfigurieren [www.teamitaliailluminazione.it](http://www.teamitaliailluminazione.it)

**E323BVE2** 3x E27 max 42W ES / 10W LED - 220V **512,00 €**

**E27** Sorgente E27 non inclusa - E27 light source not included - E27 Lichtquelle nicht enthalten

[Configura](#) Configure / Konfigurieren [www.teamitaliailluminazione.it](http://www.teamitaliailluminazione.it)

BV



configurazione standard: / basic configuration: / Standard Konfiguration:

E2 Opale - Opal

**B 3000K**

BV

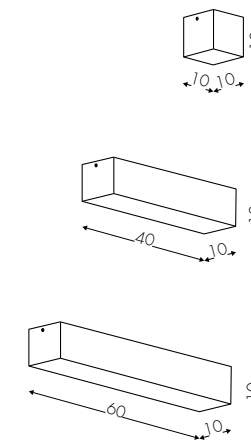

**E320BVE2B** 4W 350lm\* - 220V **182,00 €**

[Configura](#) Configure / Konfigurieren [www.teamitaliailluminazione.it](http://www.teamitaliailluminazione.it)

**D322BVE2B** 21W 2420lm - 220V **392,00 €**

**D322DMBVE2B** DALI (Push) - 21W 2420lm - 220V **462,00 €**

[Configura](#) Configure / Konfigurieren [www.teamitaliailluminazione.it](http://www.teamitaliailluminazione.it)

**D323BVE2B** 29W 3400lm - 220V **512,00 €**

**D323DMBVE2B** DALI (Push) - 29W 3400lm - 220V **597,00 €**

[Configura](#) Configure / Konfigurieren [www.teamitaliailluminazione.it](http://www.teamitaliailluminazione.it)

BV



**A 2700K**

**A** Alimentatore Incorporato - Incorporated Power Supply - Eingebautes Netzteil

\* 350lm effettivi - effective - effektive con - with - mit **E2**

**CODICE COMPLETO DEL PRODOTTO NELLA FOTO**  
FULL PRODUCT CODE AS SHOWN IN PICTURE - VOLLSTÄNDIGER CODE VOM ARTIKEL IM BILD

**E321**

Codice  
Code

**BV**

Finitura  
Finishing  
Lackierung

**E2**

Diffusore  
Diffuser  
Diffusor





configurazione standard: / basic configuration: / Standard Konfiguration:

E2 Opale - Opal

● B 3000K

BV

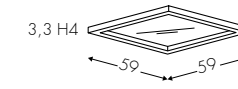

**3028IOFBVE2B**  
**3028IDMBVE2B**

50W 3100lm\* - 220V  
DALI (Push) - 50W 3100lm - 220V

**833,00 €**  
**932,00 €**

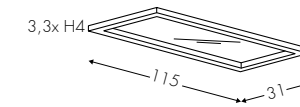

**3028EOFBVE2B**  
**3028EDMBVE2B**

62W 4560lm - 220V  
DALI (Push) - 62W 4560lm - 220V

**877,00 €**  
**977,00 €**

Configura 

Configure / Konfigurieren

[www.teamitaliailluminazione.it](http://www.teamitaliailluminazione.it) 



E19 Prismatico - Prism

● A 2700K

NE RU

A Alimentatore Incorporato - Incorporated Power Supply - Eingebautes Netzteil

\* 3100lm effettivi - effective - effektive con - with - mit **E2**  
3650lm effettivi - effective - effektive con - with - mit **E19** ↻ +17,5%

 **CODICE COMPLETO DEL PRODOTTO NELLA FOTO**  
FULL PRODUCT CODE AS SHOWN IN PICTURE - VOLLSTÄNDIGER CODE VOM ARTIKEL IM BILD

**3028EOF** **NE** **E2** **B**

Codice  
Code

Finitura  
Finishing  
Lackierung

Diffusore  
Diffuser  
Diffusor

Tonalità  
Hue  
Farbton



configurazione standard: / basic configuration: / Standard Konfiguration:

E2 Opale - Opal

● B 3000K

BV

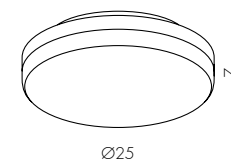

**3080BOFBVE2B**

12W 1300lm\* - 220V

**78,00 €**

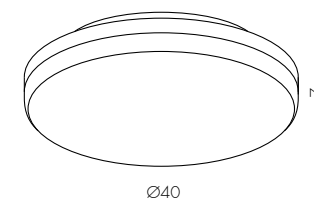

**3080DOFBVE2B**

30W 3000lm - 220V

**148,00 €**

Configura

Configure / Konfigurieren

[www.teamitaliailluminazione.it](http://www.teamitaliailluminazione.it)



BV



A Alimentatore Incorporato - Incorporated Power Supply - Eingebautes Netzteil

\* 1300lm effettivi - effective - effektiven con - with - mit **E2**

**CODICE COMPLETO DEL PRODOTTO NELLA FOTO**  
FULL PRODUCT CODE AS SHOWN IN PICTURE - VOLLSTÄNDIGER CODE VOM ARTIKEL IM BILD

**3080DOF** **BV** **E2** **B**

Codice Code	Finitura Finishing Lackierung	Diffusore Diffuser Diffusor	Tonalità Hue Farbton
----------------	-------------------------------------	-----------------------------------	----------------------------



configurazione standard: / basic configuration: / Standard Konfiguration:

E2 Opale - Opal ● B 3000K

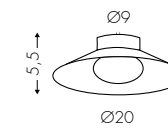

**3076ATFNEE2B** 10W 650lm\* - 220V

**198,00 €**

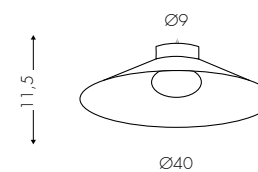

**3076CTFNEE2B** 17W 1100lm - 220V

**315,00 €**

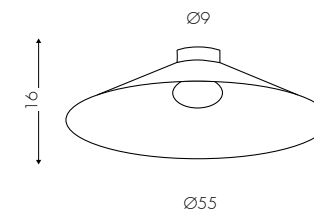

**3076DTFNEE2B** 17W 1100lm - 220V

**368,00 €**

Configura Configure / Konfigurieren

[www.teamitaliailluminazione.it](http://www.teamitaliailluminazione.it)



● A 2700K



**CODICE COMPLETO DEL PRODOTTO NELLA FOTO**  
FULL PRODUCT CODE AS SHOWN IN PICTURE - VOLLSTÄNDIGER CODE VOM ARTIKEL IM BILD

**3076CTF** **ZN** **E2** **A**

Codice Code	Finitura Finishing Lackierung	Diffusore Diffuser Diffusor	Tonalità Hue Farbton
----------------	-------------------------------------	-----------------------------------	----------------------------

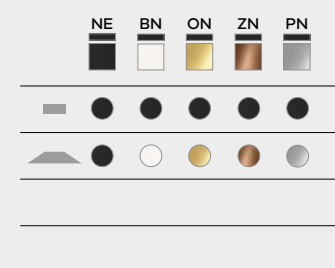

**TF** Taglio di Fase - Phase-Cut Dimmer - Phasenabschnittdimmer  
**A** Alimentatore Incorporato - Incorporated Power Supply - Eingebautes Netzteil

\* 650lm effettivi - effective - effektiven con - with - mit **E2**



# LEGGERA

PLAFONE  
CEILING LIGHT  
DECKENLEUCHE



configurazione standard: / basic configuration: / Standard Konfiguration:

E2 Opale - Opal

● B 3000K

BV

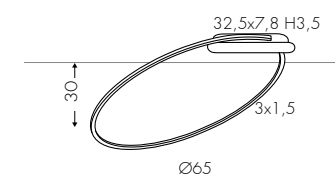

**3032AOFBVE2B**

35W 1740lm\* - 220V

**601,00 €**

**3032ADMBVE2B**

DALI (Push) - 35W 1740lm - 220V

**697,00 €**

**3032ATFBVE2B**

35W 1740lm - 220V

**697,00 €**

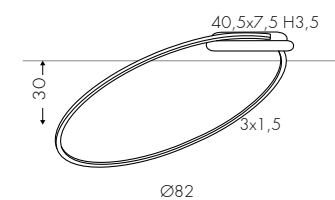

**3032BOFBVE2B**

48W 2580lm - 220V

**709,00 €**

**3032BDMBVE2B**

DALI (Push) - 48W 2580lm - 220V

**808,00 €**

**3032BTFBVE2B**

48W 2580lm - 220V

**808,00 €**

Configura

Configure / Konfigurieren

[www.teamitaliailluminazione.it](http://www.teamitaliailluminazione.it)



● A 2700K



**CODICE COMPLETO DEL PRODOTTO NELLA FOTO**  
FULL PRODUCT CODE AS SHOWN IN PICTURE - VOLLSTÄNDIGER CODE VOM ARTIKEL IM BILD

**3032BOF** | **BR** | **E2** | **B**

Codice  
Code

Finitura  
Finishing  
Lackierung

Diffusore  
Diffuser  
Diffusor

Tonalità  
Hue  
Farbton

**TF** Taglio di Fase - Phase-Cut Dimmer - Phasenabschnittdimmer

**A** Alimentatore Incorporato - Incorporated Power Supply - Eingebautes Netzteil

\* 1740lm effettivi - effective - effektive con - with - mit **E2**

# LEGGERA

PLAFONE  
CEILING LIGHT  
DECKENLEUCHTE



configurazione standard: / basic configuration: / Standard Konfiguration:

E2 Opale - Opal

● B 3000K

BV

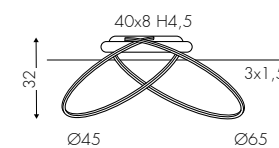

**3032ACTFBVE2B**

60W 2976lm\* - 220V

**979,00 €**

**3032ACDMBVE2B**

DALI (Push) - 60W 2976lm - 220V

**979,00 €**

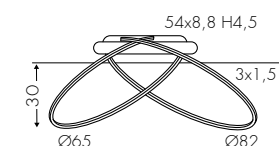

**3032ABOFBVE2B**

83W 4320lm - 220V

**1.236,00 €**

**3032ABDMBVE2B**

DALI (Push) - 83W 4320lm - 220V

**1.380,00 €**

**3032ABTFBVE2B**

83W 4320lm - 220V

**1.380,00 €**

Configura

Configure / Konfigurieren

[www.teamitaliailluminazione.it](http://www.teamitaliailluminazione.it)



● A 2700K



**CODICE COMPLETO DEL PRODOTTO NELLA FOTO**  
FULL PRODUCT CODE AS SHOWN IN PICTURE - VOLLSTÄNDIGER CODE VOM ARTIKEL IM BILD

**3032ABOF** **RV** **E2** **B**

Codice  
Code

Finitura  
Finishing  
Lackierung

Diffusore  
Diffuser  
Diffusor

Tonalità  
Hue  
Farbton

**TF** Taglio di Fase - Phase-Cut Dimmer - Phasenabschnittdimmer

**A** Alimentatore Incorporato - Incorporated Power Supply - Eingebautes Netzteil

\* 2976lm effettivi - effective - effektive con - with - mit **E2**



# LEGGERA

PLAFONE  
CEILING LIGHT  
DECKENLEUCHTE



configurazione standard: / basic configuration: / Standard Konfiguration:

E2 Opale - Opal

● B 3000K

BV



**3032GOFBVE2B**

35W 1740lm\* - 220V

**493,00 €**

**3032GDMBVE2B**

DALI (Push) - 35W 1740lm - 220V

**586,00 €**

**3032GTFBVE2B**

35W 1740lm - 220V

**586,00 €**

Configura

Configure / Konfigurieren

[www.teamitaliailluminazione.it](http://www.teamitaliailluminazione.it)



● A 2700K



**CODICE COMPLETO DEL PRODOTTO NELLA FOTO**  
FULL PRODUCT CODE AS SHOWN IN PICTURE - VOLLSTÄNDIGER CODE VOM ARTIKEL IM BILD

**3032GOF** **NE** **E2** **B**

Codice  
Code

Finitura  
Finishing  
Lackierung

Diffusore  
Diffuser  
Diffusor

Tonalità  
Hue  
Farbton

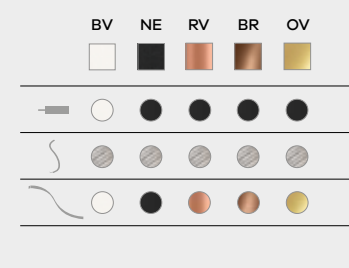

**TF** Taglio di Fase - Phase-Cut Dimmer - Phasenabschnittdimmer

**A** Alimentatore nel rosone - Power Supply inside the ceiling rose - Netzteil in der Deckendose

\* 1740lm effettivi - effective - effektive con - with - mit **E2**

INDEX

SECTION

FAMILY 209





configurazione standard: / basic configuration: / Standard Konfiguration:

24° Ottica - Optic - Optik ● B 3000K

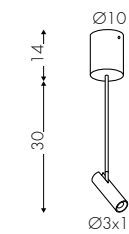

<b>3039AOFBV24B</b>	3W 360lm* - 220V	<b>257,00 €</b>
<b>3039ADMBV24B</b>	DALI (Push) - 3W 360lm - 220V	<b>318,00 €</b>
<b>3039ATFBV24B</b>	3W 360lm - 220V	<b>282,00 €</b>

Configura  Configure / Konfigurieren

[www.teamitaliailluminazione.it](http://www.teamitaliailluminazione.it) 

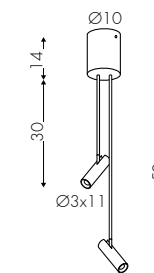

<b>3039BOFBV24B</b>	2x3W 2x360lm - 220V	<b>351,00 €</b>
<b>3039BDMBV24B</b>	DALI (Push) - 2x3W 2x360lm - 220V	<b>398,00 €</b>
<b>3039BTFBV24B</b>	2x3W 2x360lm - 220V	<b>374,00 €</b>

Configura  Configure / Konfigurieren

[www.teamitaliailluminazione.it](http://www.teamitaliailluminazione.it) 



C 4000K



 **CODICE COMPLETO DEL PRODOTTO NELLA FOTO**  
FULL PRODUCT CODE AS SHOWN IN PICTURE - VOLLSTÄNDIGER CODE VOM ARTIKEL IM BILD

**3039BOF** **NE** **24** **B**

Codice Code	Finitura Finishing Lackierung	Diffusore Diffuser Diffusor	Tonalità Hue Farbton
----------------	-------------------------------------	-----------------------------------	----------------------------

**TF** Taglio di Fase - Phase-Cut Dimmer - Phasenabschnittdimmer  
**A** Alimentatore Incorporato - Incorporated Power Supply - Eingebautes Netzteil

\* 360lm effettivi - effective - effektive con - with - mit 24°



# MICRO

PLAFONE  
CEILING LIGHT  
DECKENLEUCHTE



configurazione standard: / basic configuration: / Standard Konfiguration:

+ E2 Opale - Opal  
24° Ottica - Optic - Optik

B 3000K

BV

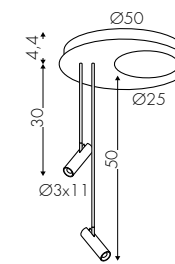

<b>3039EOFBV24B</b>	2x3W 2x360lm* + 15W 1500lm - 220V	<b>557,00 €</b>
<b>3039EDMBV24B</b>	DALI (Push) - 2x3W 2x360lm + 15W 1500lm - 220V	<b>610,00 €</b>
<b>3039ETFBV24B</b>	2x3W 2x360lm + 15W 1500lm - 220V	<b>637,00 €</b>

Configura Configure / Konfigurieren

[www.teamitaliailluminazione.it](http://www.teamitaliailluminazione.it)



C 4000K



**CODICE COMPLETO DEL PRODOTTO NELLA FOTO**  
FULL PRODUCT CODE AS SHOWN IN PICTURE - VOLLSTÄNDIGER CODE VOM ARTIKEL IM BILD

**3039EOF** **ON** **24** **C**

Codice  
Code

Finitura  
Finishing  
Lackierung

Diffusore  
Diffuser  
Diffusor

Tonalità  
Hue  
Farbton

**TF** Taglio di Fase - Phase-Cut Dimmer - Phasenabschnittdimmer  
**A** Alimentatore Incorporato - Incorporated Power Supply - Eingebautes Netzteil

\* 360lm effettivi - effective - effektive con - with - mit **24**





configurazione standard: / basic configuration: / Standard Konfiguration:

+ E2 Opale - Opal  
24° Ottica - Optic - Optik

B 3000K

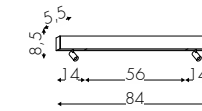

**3030A11OFBVE2B**  
**3030A11DMBVE2B**

Spot 2x7W 2x680lm - 18W 1770lm\* - 220V  
DALI (Push) - Spot 2x7W 2x680lm - 18W 1770lm - 220V

**638,00 €**  
**895,00 €**

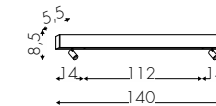

**3030C11OFBVE2B**  
**3030C11DMBVE2B**

Spot 2x7W 2x680lm - 35W 3009lm - 220V  
DALI (Push) - Spot 2x7W 2x680lm - 35W 3009lm - 220V

**852,00 €**  
**1.146,00 €**

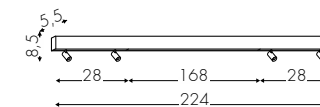

**3030F22OFBVE2B**  
**3030F22DMBVE2B**

Spot 4x7W 4x680lm - 53W 4513lm - 220V  
DALI (Push) - Spot 4x7W 4x680lm - 53W 4513lm - 220V

**1.135,00 €**  
**1.491,00 €**

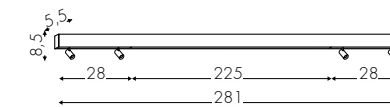

**3030H22OFBVE2B**  
**3030H22DMBVE2B**

Spot 4x7W 4x680lm - 70W 6020lm - 220V  
DALI (Push) - Spot 4x7W 4x680lm - 70W 6020lm - 220V

**1.548,00 €**  
**1.914,00 €**

Configura

Configure / Konfigurieren

[www.teamitaliailluminazione.it](http://www.teamitaliailluminazione.it)



B 3000K



**A** Alimentatore Incorporato - Incorporated Power Supply - Eingebautes Netzteil

\* 1770lm effettivi - effective - effektive con - with - mit E2

**↑** CODICE COMPLETO DEL PRODOTTO NELLA FOTO  
FULL PRODUCT CODE AS SHOWN IN PICTURE - VOLLSTÄNDIGER CODE VOM ARTIKEL IM BILD

**3030F22OF** **NE** **E2** **B**

Codice  
Code

Finitura  
Finishing  
Lackierung

Diffusore  
Diffuser  
Diffusor

Tonalità  
Hue  
Farbton





configurazione standard: / basic configuration: / Standard Konfiguration:

E2 Opale - Opal

● B 3000K

BV

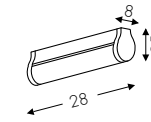

**3060ATFBVE2B**

7W 714lm\* - 220V

**188,00 €**

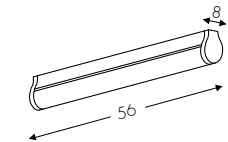

**3060STFBVE2B**

13W 1428lm - 220V

**228,00 €**

**3060SDMBVE2B**

DALI (Push) 13W 1428lm - 220V

**272,00 €**

Configura 

Configure / Konfigurieren

[www.teamitaliailluminazione.it](http://www.teamitaliailluminazione.it) 

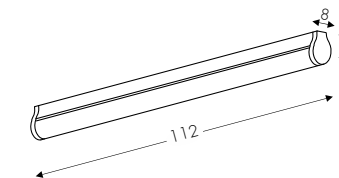

**3060BOFBVE2B**

25W 2856lm - 220V

**299,00 €**

**3060BDMBVE2B**

DALI (Push) - 25W 2856lm - 220V

**350,00 €**

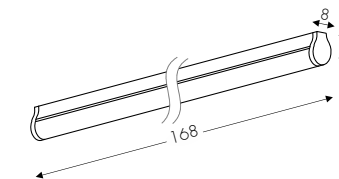

**3060DOFBVE2B**

37W 4290lm - 220V

**345,00 €**

**3060DDMBVE2B**

DALI (Push) - 37W 4290lm - 220V

**399,00 €**

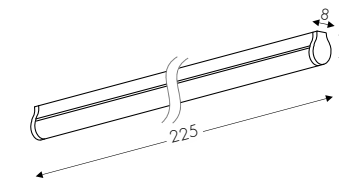

**3060FOFBVE2B**

50W 5738lm - 220V

**437,00 €**

**3060FDMBVE2B**

DALI (Push) - 50W 5738lm - 220V

**495,00 €**

Configura 

Configure / Konfigurieren

[www.teamitaliailluminazione.it](http://www.teamitaliailluminazione.it) 



● A 2700K ○ C 4000K

NE



 **CODICE COMPLETO DEL PRODOTTO NELLA FOTO**  
FULL PRODUCT CODE AS SHOWN IN PICTURE - VOLLSTÄNDIGER CODE VOM ARTIKEL IM BILD

**3060DTF** **NE** **E2** **B**

Codice  
Code

Finitura  
Finishing  
Lackierung

Diffusore  
Diffuser  
Diffusor

Tonalità  
Hue  
Farbton

**TF** Taglio di Fase - Phase-Cut Dimmer - Phasenabschnittdimmer

**A** Alimentatore Incorporato - Incorporated Power Supply - Eingebautes Netzteil

\* 714lm effettivi - effective - effektive con - with - mit **E2**



configurazione standard: / basic configuration: / Standard Konfiguration:

24° Ottica - Optic - Optik ● B 3000K

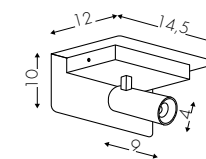

**3033AOFBV24B** 1x7W 680lm\* - 220V

**179,00 €**

**3033ATFBV24B** 1x7W 680lm - 220V

**196,00 €**

Configura Configure / Konfigurieren

[www.teamitaliailluminazione.it](http://www.teamitaliailluminazione.it)

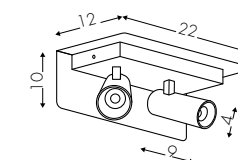

**3033BOFBV24B** 2x7W 2x680lm - 220V

**276,00 €**

**3033BDMBV24B** DALI (Push) - 2x7W 2x680lm - 220V

**318,00 €**

**3033BTFBV24B** 2x7W 2x680lm - 220V

**285,00 €**

Configura Configure / Konfigurieren

[www.teamitaliailluminazione.it](http://www.teamitaliailluminazione.it)

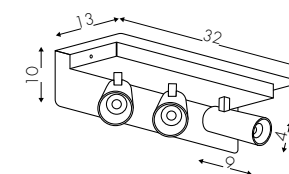

**3033COFBV24B** 3x7W 3x680lm - 220V

**333,00 €**

**3033CDMBV24B** DALI (Push) - 3x7W 3x680lm - 220V

**386,00 €**

**3033CTFBV24B** 3x7W 3x680lm - 220V

**370,00 €**

Configura Configure / Konfigurieren

[www.teamitaliailluminazione.it](http://www.teamitaliailluminazione.it)



○ C 4000K



**CODICE COMPLETO DEL PRODOTTO NELLA FOTO**  
FULL PRODUCT CODE AS SHOWN IN PICTURE - VOLLSTÄNDIGER CODE VOM ARTIKEL IM BILD

**3033BOF** **NE** **24** **B**

Codice  
Code

Finitura  
Finishing  
Lackierung

Diffusore  
Diffuser  
Diffusor

Tonalità  
Hue  
Farbton







configurazione standard: / basic configuration: / Standard Konfiguration:

+ E2 Opale - Opal  
24° Ottica - Optic - Optik

B 3000K

BV

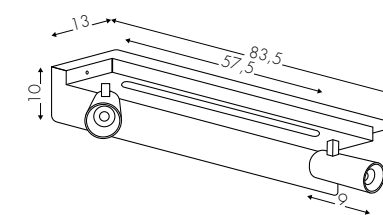

**3033EOFBV24B**

25W 2860lm + 2x7W 2x680lm\* - 220V

**364,00 €**

**3033EDMBV24B**

DALI (Push) - 25W 2860lm + 2x7W 2x680lm - 220V

**434,00 €**

**3033ETFVBV24B**

25W 2860lm + 2x7W 2x680lm - 220V

**393,00 €**

Configura

Configure / Konfigurieren

[www.teamitaliailluminazione.it](http://www.teamitaliailluminazione.it)



C 4000K



**CODICE COMPLETO DEL PRODOTTO NELLA FOTO**  
FULL PRODUCT CODE AS SHOWN IN PICTURE - VOLLSTÄNDIGER CODE VOM ARTIKEL IM BILD

**3033EOF** **NE** **24** **B**

Codice  
Code

Finitura  
Finishing  
Lackierung

Diffusore  
Diffuser  
Diffusor

Tonalità  
Hue  
Farbton

**TF** Taglio di Fase - Phase-Cut Dimmer - Erhältlich Phasenabschnittdimmer

**A** Alimentatore Incorporato - Incorporated Power Supply - Eingebautes Netzteil

\* 680lm effettivi - effective - effektive con - with - mit 24°





configurazione standard: / basic configuration: / Standard Konfiguration:

E28 Satinato  
Frosted - Satiniert ● B 3000K BV

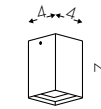

**3009BTFBVE28B** 4.3W 420lm\* - 220V **110,00 €**  
[Configura](#) Configure / Konfigurieren [www.teamitaliailluminazione.it](http://www.teamitaliailluminazione.it)

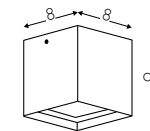

**3009ATFBVE28B** 13W 1000lm - 220V **134,00 €**  
[Configura](#) Configure / Konfigurieren [www.teamitaliailluminazione.it](http://www.teamitaliailluminazione.it)

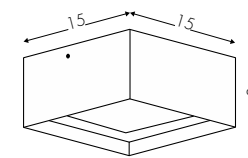

**3009DTFBVE28B** 20W 1700lm - 220V **184,00 €**

[Configura](#) Configure / Konfigurieren [www.teamitaliailluminazione.it](http://www.teamitaliailluminazione.it)



**CODICE COMPLETO DEL PRODOTTO NELLA FOTO**  
**FULL PRODUCT CODE AS SHOWN IN PICTURE - VOLLSTÄNDIGER CODE VOM ARTIKEL IM BILD**

**3009ATF** **BV** **E28** **B**

Codice Code	Finitura Finishing Lackierung	Diffusore Diffuser Diffusor	Tonalità Hue Farbton
----------------	-------------------------------------	-----------------------------------	----------------------------

**TF** Taglio di Fase - Phase-Cut Dimmer - Phasenabschnittdimmer  
**A** Alimentatore Incorporato - Incorporated Power Supply - Eingebautes Netzteil

\* 420lm effettivi - effective - effektive con - with - mit **E28**



configurazione standard: / basic configuration: / Standard Konfiguration:

**E28** Satinato  
Frosted - Satiniert

**B** 3000K

BV

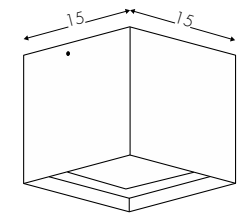

**3009CTFBVE28B** 20W 1700lm\* - 220V  
**3009COFEMBVE28B** 20W 1700lm - 220V

**214,00 €**  
**385,00 €**

Configura Configura / Konfigurieren

[www.teamitaliailluminazione.it](http://www.teamitaliailluminazione.it)



**A** 2700K  **C** 4000K

NE RU

configurazione standard: / basic configuration: / Standard Konfiguration:

**28°** Ottica  
Optics - Optik

**B** 3000K

BV

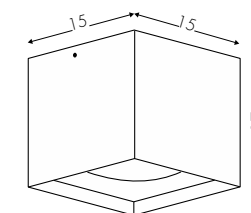

**3009COF28BV28B** 18W 2500lm - 220V  
**3009CDM28BV28B** DALI (Push) - 18W 2500lm - 220V  
**3009CTF28BV28B** 18W 2500lm - 220V

**267,00 €**  
**299,00 €**  
**299,00 €**

Configura Configura / Konfigurieren

[www.teamitaliailluminazione.it](http://www.teamitaliailluminazione.it)



**C** 4000K

NE RU

**CODICE COMPLETO DEL PRODOTTO NELLA FOTO**  
FULL PRODUCT CODE AS SHOWN IN PICTURE  
VOLLSTÄNDIGER CODE VOM ARTIKEL IM BILD

**3009CTF** **BV** **E28** **B**

Codice  
Code

Finitura  
Finishing  
Lackierung

Diffusore  
Diffuser  
Diffusor

Tonalità  
Hue  
Farbton

**EM** Emergenza - Emergency - Notbeleuchtung  
**TF** Taglio di Fase - Phase-Cut Dimmer - Erhältlich Phasenabschnittdimmer  
**A** Alimentatore Incorporato - Incorporated Power Supply - Eingebautes Netzteil

\* 1700lm effettivi - effective - effektive con - with - mit **E28**



configurazione standard: / basic configuration: / Standard Konfiguration:

**E28** Satinato  
Frosted - Satiniert

**B** 3000K

BV

**30090TFBVE28B**

20W 1700lm\* + 8W 950lm - 220V

**286,00 €**

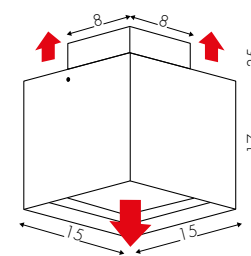

Configura

Configure / Konfigurieren

[www.teamitaliailluminazione.it](http://www.teamitaliailluminazione.it)



**A** 2700K  **C** 4000K

NE RU

**CODICE COMPLETO DEL PRODOTTO NELLA FOTO**  
FULL PRODUCT CODE AS SHOWN IN PICTURE - VOLLSTÄNDIGER CODE VOM ARTIKEL IM BILD

**30090TF** **NE** **E28** **B**

Codice  
Code

Finitura  
Finishing  
Lackierung

Diffusore  
Diffuser  
Diffusor

Tonalità  
Hue  
Farbton

**TF** Taglio di Fase - Phase-Cut Dimmer - Erhältlich Phasenabschnittdimmer

**A** Alimentatore Incorporato - Incorporated Power Supply - Eingebautes Netzteil

\* 1700lm effettivi - effective - effektive con - with - mit **E28**





configurazione standard: / basic configuration: / Standard Konfiguration:

E2 Opale - Opal ● B 3000K

BV

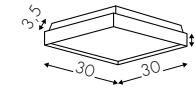

<b>3009EOFBVE2B</b>	18W 1870lm* - 220V	<b>271,00 €</b>
<b>3009EDMBVE2B</b>	DALI (Push) - 18W 1870lm - 220V	<b>324,00 €</b>
<b>3009ETFBVE2B</b>	18W 1870lm - 220V	<b>302,00 €</b>
<b>3009EOFEMBVE2B</b>	18W 1870lm - 220V	<b>455,00 €</b>

Configura Configure / Konfigurieren

[www.teamitaliailluminazione.it](http://www.teamitaliailluminazione.it)

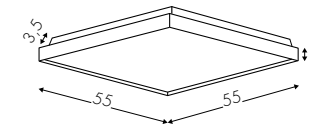

<b>3009FOFBVE2B</b>	50W 5270lm - 220V	<b>476,00 €</b>
<b>3009FDMBVE2B</b>	DALI (Push) - 50W 5270lm - 220V	<b>535,00 €</b>
<b>3009FTFBVE2B</b>	50W 5270lm - 220V	<b>512,00 €</b>
<b>3009FOFEMBVE2B</b>	50W 5270lm - 220V	<b>649,00 €</b>

Configura Configure / Konfigurieren

[www.teamitaliailluminazione.it](http://www.teamitaliailluminazione.it)

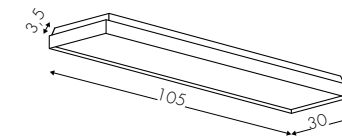

<b>3009LOFBVE2B</b>	50W 5270lm - 220V	<b>476,00 €</b>
<b>3009LDMBVE2B</b>	DALI (Push) - 50W 5270lm - 220V	<b>535,00 €</b>
<b>3009LTFBVE2B</b>	50W 5270lm - 220V	<b>512,00 €</b>
<b>3009LOFEMBVE2B</b>	50W 5270lm - 220V	<b>649,00 €</b>

Configura Configure / Konfigurieren

[www.teamitaliailluminazione.it](http://www.teamitaliailluminazione.it)



E19 UGR<19 Prism ● C 4000K

NE



**CODICE COMPLETO DEL PRODOTTO NELLA FOTO**  
FULL PRODUCT CODE AS SHOWN IN PICTURE - VOLLSTÄNDIGER CODE VOM ARTIKEL IM BILD

**3009FOF** **NE** **E2** **B**

Codice  
Code

Finitura  
Finishing  
Lackierung

Diffusore  
Diffuser  
Diffusor

Tonalità  
Hue  
Farbton

- EM** Emergenza - Emergency - Notbeleuchtung
- TF** Taglio di Fase - Phase-Cut Dimmer - Erhältlich Phasenabschnittdimmer
- A** Alimentatore Incorporato - Incorporated Power Supply - Eingebautes Netzteil

\* 1870lm effettivi - effective - effektive con - with - mit **E2**  
2200lm effettivi - effective - effektive con - with - mit **E19** +17,5%



RV custom finish

configurazione standard: / basic configuration: / Standard Konfiguration:

**E28** Satinato  
Frosted - Satiniert

**B** 3000K

BV

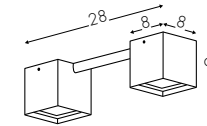

**3009MTFBVE28B** 26W 2000lm\* - 220V

296,00 €

Configura Configura / Konfigurieren

[www.teamitaliailluminazione.it](http://www.teamitaliailluminazione.it)

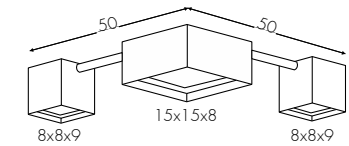

**3009NTFBVE28B** 43W 3500lm - 220V

477,00 €

Configura Configura / Konfigurieren

[www.teamitaliailluminazione.it](http://www.teamitaliailluminazione.it)



NE RU

**CODICE COMPLETO DEL PRODOTTO NELLA FOTO**  
FULL PRODUCT CODE AS SHOWN IN PICTURE - VOLLSTÄNDIGER CODE VOM ARTIKEL IM BILD

**3009MTF** **RV** **E28** **B**

Codice  
Code

Finitura  
Finishing  
Lackierung

Diffusore  
Diffuser  
Diffusor

Tonalità  
Hue  
Farbton

**TF** Taglio di Fase - Phase-Cut Dimmer - Phasenabschnittdimmer

**A** Alimentatore Incorporato - Incorporated Power Supply - Eingebautes Netzteil

\* 2000lm effettivi - effective - effektive con - with - mit **E28**



custom red cable

configurazione standard: / basic configuration: / Standard Konfiguration:

+ E2 Opale - Opal  
E28 Satinato - Frosted - Satiniert ● B 3000K

BV

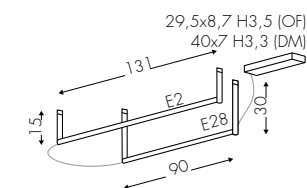

**3015IOFBVE2B**  
**3015IDMBVE2B**

26W 2295lm + 38W 2730lm\* - 220V  
DALI (Push) - 26W 2295lm + 38W 2730lm - 220V

**600,00 €**  
**694,00 €**

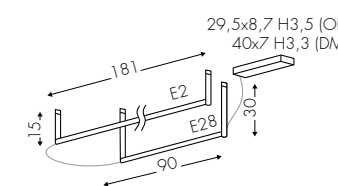

**3015LOFBVE2B**  
**3015LDMBVE2B**

26W 2295lm + 52W 3780lm - 220V  
DALI (Push) - 26W 2295lm + 52W 3780lm - 220V

**686,00 €**  
**794,00 €**

Configura Configure / Konfigurieren

[www.teamitaliailluminazione.it](http://www.teamitaliailluminazione.it)

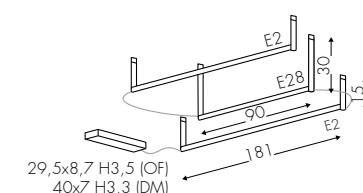

**3015MOFBVE2B**  
**3015MDMBVE2B**

2x52W 7560lm + 26W 2295lm - 220V  
DALI (Push) - 2x52W 7560lm + 26W 2295lm - 220V

**967,00 €**  
**1.097,00 €**

● C005T2BV Custom white cable **8,00 € /MT**

● C005T2RO Custom red cable **8,00 € /MT**

Configura Configure / Konfigurieren

[www.teamitaliailluminazione.it](http://www.teamitaliailluminazione.it)



BV

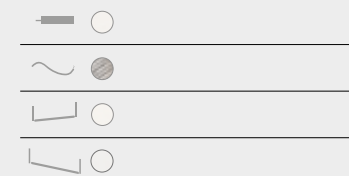

A Alimentatore nel rosone - Power Supply inside the ceiling rose - Netzteil in der Deckendose

\* 2730lm effettivi - effective - effektive con - with - mit E2

**CODICE COMPLETO DEL PRODOTTO NELLA FOTO**  
FULL PRODUCT CODE AS SHOWN IN PICTURE - VOLLSTÄNDIGER CODE VOM ARTIKEL IM BILD

**3015IOF** **BV** **E2** **B** + **C005T2RO**

Codice  
Code

Finitura  
Finishing  
Lackierung

Diffusore  
Diffuser  
Diffusor

Tonalità  
Hue  
Farbton

Codice  
Code

custom RED CABLE



# OVERLAP DECÒ

PLAFONE  
CEILING LIGHT  
DECKENLEUCHE



configurazione standard: / basic configuration: / Standard Konfiguration:

E2 Opale - Opal

● B 3000K

BV

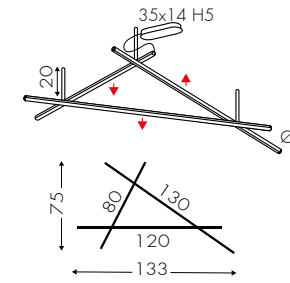

**3015QTFBVE2B**

up 29W 2100lm - down 46W 3400lm\* - 220V

**780,00 €**

**3015QDMBVE2B**

DALI (Push) - up 29W 2100lm - down 46W 3400lm\* - 220V

**860,00 €**

**3015QSDBVE2B**

up 29W 2100lm - down 46W 3400lm\* - 220V

**860,00 €**

Configura

Configure / Konfigurieren

[www.teamitaliailluminazione.it](http://www.teamitaliailluminazione.it)

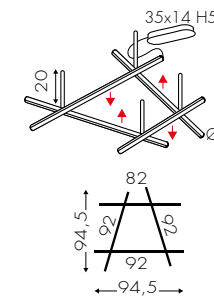

**3015OTFBVE2B**

up 40W 3000lm - down 38W 2900lm - 220V

**780,00 €**

**3015ODMBVE2B**

DALI (Push) - up 40W 3000lm - down 38W 2900lm - 220V

**860,00 €**

**3015OSDBVE2B**

up 40W 3000lm - down 38W 2900lm - 220V

**860,00 €**

Configura

Configure / Konfigurieren

[www.teamitaliailluminazione.it](http://www.teamitaliailluminazione.it)

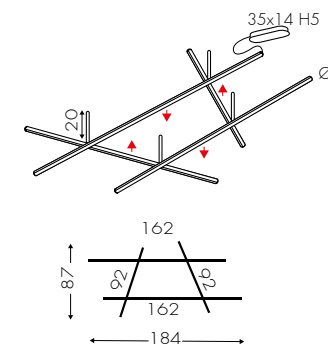

**3015PTFBVE2B**

up 40W 3100lm - down 70W 5400lm - 220V

**890,00 €**

**3015PDMBVE2B**

DALI (Push) - up 40W 3100lm - down 70W 5400lm - 220V

**970,00 €**

**3015PSDBVE2B**

up 40W 3100lm - down 70W 5400lm - 220V

**970,00 €**

Configura

Configure / Konfigurieren

[www.teamitaliailluminazione.it](http://www.teamitaliailluminazione.it)



● A 2700K

NE RU OV BR RV

**CODICE COMPLETO DEL PRODOTTO NELLA FOTO**  
FULL PRODUCT CODE AS SHOWN IN PICTURE - VOLLSTÄNDIGER CODE VOM ARTIKEL IM BILD

**3015OTF BR E2 B**

Codice Code  
Finitura Finishing Lackierung  
Diffusore Diffuser Diffusor  
Tonalità Hue Farbton

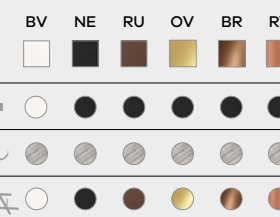

**A** Alimentatore nel rosone - Power Supply inside the ceiling rose - Netzteil in der Deckendose

**TF** Taglio di Fase - Phase-Cut Dimmer - Phasenabschnittdimmer

**SD** Telecomando radio - Smart Dimmer - Smart Dimmer

\* 5500lm effettivi - effective - effektiven con - with - mit **E2**





configurazione standard: / basic configuration: / Standard Konfiguration:

E2 Opale - Opal

B 3000K

BV

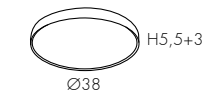

**3067BOFBVE2B**  
**3067BDMBVE2B**

26W 3586lm\* - 220V  
DALI (Push) - 26W 3586lm - 220V

**410,00 €**  
**530,00 €**

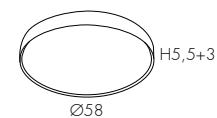

**3067DOFBVE2B**  
**3067DDMBVE2B**

47W 6500lm - 220V  
DALI (Push) - 47W 6500lm - 220V

**595,00 €**  
**695,00 €**

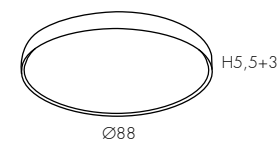

**3067FOFBVE2B**  
**3067FDMBVE2B**

70W 8220lm - 220V  
DALI (Push) - 70W 8220lm - 220V

**890,00 €**  
**990,00 €**

Configura Configure / Konfigurieren

[www.teamitaliailluminazione.it](http://www.teamitaliailluminazione.it)

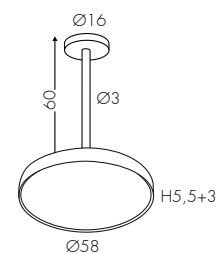

**3067QOFBVE2B**  
**3067QDMBVE2B**

26W 3586lm - 220V  
DALI (Push) - 26W 3586lm - 220V

**675,00 €**  
**775,00 €**

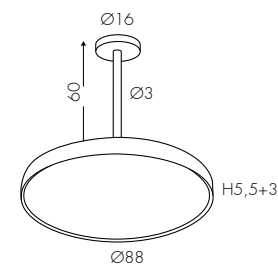

**3067ROFBVE2B**  
**3067RDMBVE2B**

47W 6500lm - 220V  
DALI (Push) - 47W 6500lm - 220V

**970,00 €**  
**1.070,00 €**

Configura Configure / Konfigurieren

[www.teamitaliailluminazione.it](http://www.teamitaliailluminazione.it)



E19 UGR<19 Prism

C 4000K

NE

**A** Alimentatore Incorporato - Incorporated Power Supply - Eingebautes Netzteil

\* 3586lm effettivi - effective - effektive con - with - mit **E2**  
4220lm effettivi - effective - effektive con - with - mit **E19** +17,5%

CODICE COMPLETO DEL PRODOTTO NELLA FOTO  
FULL PRODUCT CODE AS SHOWN IN PICTURE - VOLLSTÄNDIGER CODE VOM ARTIKEL IM BILD

**3067BOF** **NE** **E2** **B**

Codice  
Code

Finitura  
Finishing  
Lackierung

Diffusore  
Diffuser  
Diffusor

Tonalità  
Hue  
Farbton





# SHAPE

PLAFONE  
CEILING LIGHT  
DECKENLEUCHTE



configurazione standard: / basic configuration: / Standard Konfiguration:

E2 Opale - Opal

B 3000K

BV

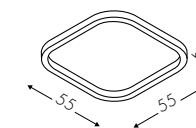

**3031AOFBVE2B**  
**3031ADMBVE2B**

52W 4510lm\* - 220V  
DALI (Push) - 52W 4510lm - 220V

**855,00 €**  
**936,00 €**

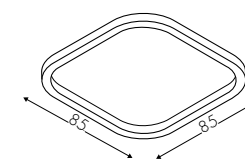

**3031BOFBVE2B**  
**3031BDMBVE2B**

83W 6800lm - 220V  
DALI (Push) - 83W 6800lm - 220V

**1.493,00 €**  
**1.604,00 €**

Configura

Configure / Konfigurieren

[www.teamitaliailluminazione.it](http://www.teamitaliailluminazione.it)

E19 UGR<19 Prism

A 2700K  C 4000K

NE RU

**CODICE COMPLETO DEL PRODOTTO NELLA FOTO**  
FULL PRODUCT CODE AS SHOWN IN PICTURE - VOLLSTÄNDIGER CODE VOM ARTIKEL IM BILD

**3031BOF** **NE** **E2** **B**

Codice  
Code

Finitura  
Finishing  
Lackierung

Diffusore  
Diffuser  
Diffusor

Tonalità  
Hue  
Farbton

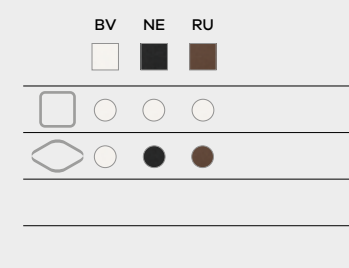

Alimentatore Incorporato - Incorporated Power Supply - Eingebautes Netzteil

\* 4510lm effettivi - effective - effektive con - with - mit **E2**  
5300lm effettivi - effective - effektive con - with - mit **E19** **+17,5%**

INDEX

SECTION

FAMILY 239



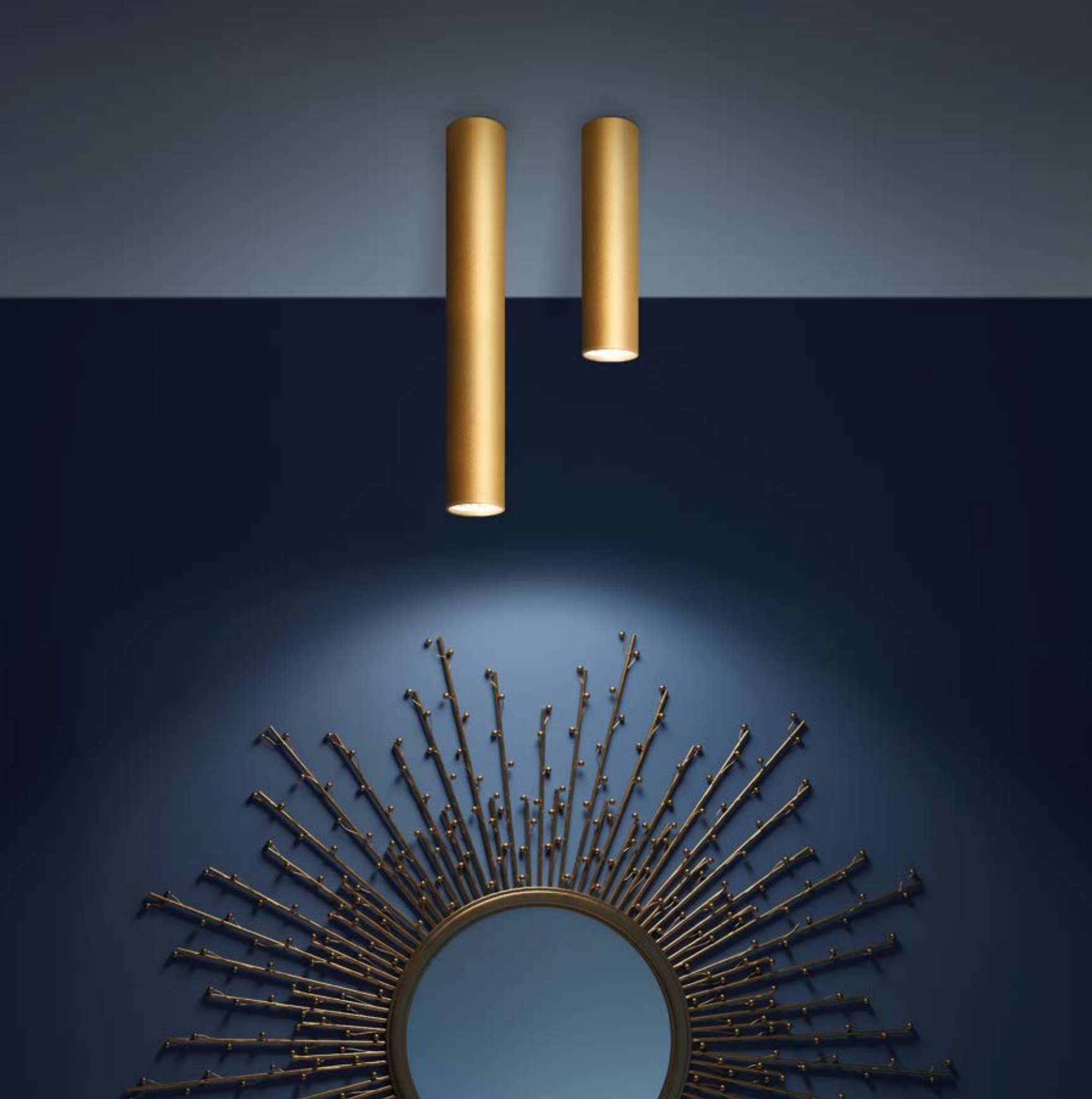

configurazione standard: / basic configuration: / Standard Konfiguration:

GU10

BV

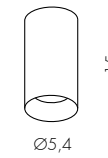

3018COFBV

1x GU10 max 7W LED - 220V

53,00 €

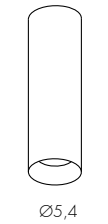

3018DOFBV

1x GU10 max 7W LED - 220V

70,00 €

Configura

Configure / Konfigurieren

[www.teamitaliailluminazione.it](http://www.teamitaliailluminazione.it)

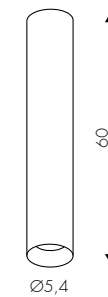

3018EOFBV

1x GU10 max 7W LED - 220V

96,00 €

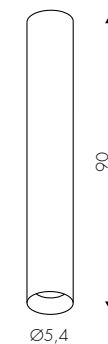

3018FOFBV

1x GU10 max 7W LED - 220V

170,00 €

Configura

Configure / Konfigurieren

[www.teamitaliailluminazione.it](http://www.teamitaliailluminazione.it)

NE RV BR OV



GU10 Sorgente GU10 non inclusa - GU10 light source not included - GU10 Lichtquelle nicht enthalten

CODICE COMPLETO DEL PRODOTTO NELLA FOTO  
FULL PRODUCT CODE AS SHOWN IN PICTURE - VOLLSTÄNDIGER CODE VOM ARTIKEL IM BILD

**3018EOF**

Codice  
Code

**OV**

Finitura  
Finishing  
Lackierung



configurazione standard: / basic configuration: / Standard Konfiguration:

**E28** Satinato  
Frosted - Satiniert BV

● **B** 3000K

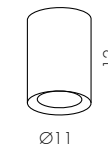

**3018ATFBVE28B** 17W 1500lm\* - 220V **172,00 €**

Configura Configura / Konfigurieren

[www.teamitaliailluminazione.it](http://www.teamitaliailluminazione.it)



○ **C** 4000K

NE RU



configurazione standard: / basic configuration: / Standard Konfiguration:

**24°** Ottica  
Optic - Optik BV

● **B** 3000K

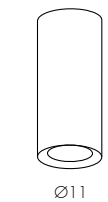

**3018BOFBV24B** 26W 3400lm - 220V **251,00 €**

**3018BDMBV24B** DALI (Push) - 26W 3400lm - 220V **308,00 €**

**3018BTFBV24B** 26W 3400lm - 220V **283,00 €**

Configura Configura / Konfigurieren

[www.teamitaliailluminazione.it](http://www.teamitaliailluminazione.it)



○ **C** 4000K

NE RU



**CODICE COMPLETO DEL PRODOTTO NELLA FOTO**  
FULL PRODUCT CODE AS SHOWN IN PICTURE - VOLLSTÄNDIGER CODE VOM ARTIKEL IM BILD

**3018ATF** **NE** **E28** **B**

Codice  
Code

Finitura  
Finishing  
Lackierung

Diffusore  
Diffuser  
Diffusor

Tonalità  
Hue  
Farbton

**TF** Taglio di Fase - Phase-Cut Dimmer - Erhältlich Phasenabschnittdimmer

**A** Alimentatore Incorporato - Incorporated Power Supply - Eingebautes Netzteil

\* 1500lm effettivi - effective - effektive con - with - mit **E28**

# S-POT

PLAFONE  
CEILING LIGHT  
DECKENLEUCHTE



configurazione standard: / basic configuration: / Standard Konfiguration:

E2 Opale - Opal

 B 3000K

BV

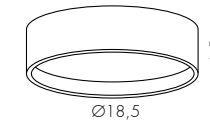

**3018GOFBVE2B**

26W 2600lm\* - 220V

**238,00 €**

**3018GDMBVE2B**

DALI (Push) - 26W 2600lm - 220V

**295,00 €**

**3018GTFBVE2B**

26W 2600lm - 220V

**295,00 €**

Configura 

Configure / Konfigurieren

[www.teamitaliailluminazione.it](http://www.teamitaliailluminazione.it) 



 **CODICE COMPLETO DEL PRODOTTO NELLA FOTO**  
FULL PRODUCT CODE AS SHOWN IN PICTURE - VOLLSTÄNDIGER CODE VOM ARTIKEL IM BILD

**3018GOF** **BV** **E2** **B**

Codice  
Code

Finitura  
Finishing  
Lackierung

Diffusore  
Diffuser  
Diffusor

Tonalità  
Hue  
Farbton

**TF** Taglio di Fase - Phase-Cut Dimmer - Erhältlich Phasenabschnittdimmer

**A** Alimentatore Incorporato - Incorporated Power Supply - Eingebautes Netzteil

\* 2600lm effettivi - effective - effektive con - with - mit **E2**

 INDEX

 SECTION

 FAMILY 245



# TABLET ROUND

PLAFONE  
CEILING LIGHT  
DECKENLEUCHTE



configurazione standard: / basic configuration: / Standard Konfiguration:

24° Ottica  
Optic - Optik

**B** 3000K

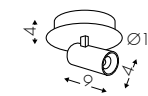

**3044POFBV24B** 7W 680lm\* - 220V

**130,00 €**

Configura Configure / Konfigurieren

[www.teamitaliailluminazione.it](http://www.teamitaliailluminazione.it)

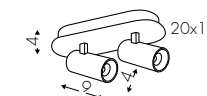

**3044QOFBV24B** 2x7W 2x680lm - 220V

**244,00 €**

**3044QDMBV24B** DALI (Push) 2x7W 2x680lm - 220V

**280,00 €**

**3044QTFBV24B** 2x7W 2x680lm - 220V

**251,00 €**

Configura Configure / Konfigurieren

[www.teamitaliailluminazione.it](http://www.teamitaliailluminazione.it)

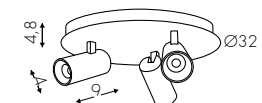

**3044GOFBV24B** 3x7W 3x680lm - 220V

**368,00 €**

**3044GDMBV24B** DALI (Push) 3x7W 3x680lm - 220V

**407,00 €**

Configura Configure / Konfigurieren

[www.teamitaliailluminazione.it](http://www.teamitaliailluminazione.it)



**C** 4000K



**TF** Taglio di Fase - Phase-Cut Dimmer - Erhältlich Phasenabschrittdimmer

**A** Alimentatore Incorporato - Incorporated Power Supply - Eingebautes Netzteil

\* 680lm effettivi - effective - effektive con - with - mit 24°



# TABLET ROUND

PLAFONE  
CEILING LIGHT  
DECKENLEUCHTE



configurazione standard: / basic configuration: / Standard Konfiguration:

+ E2 Opale - Opal  
24° Ottica - Optic - Optik

B 3000K

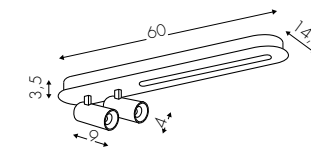

<b>3044SOFBV24B</b>	25W 2860lm + 2x7W 2x680lm* - 220V	<b>353,00</b>	€
<b>3044SDMBV24B</b>	DALI (Push) - 25W 2860lm + 2x7W 2x680lm - 220V	<b>420,00</b>	€
<b>3044STFBV24B</b>	25W 2860lm + 2x7W 2x680lm - 220V	<b>381,00</b>	€

Configura Configura / Konfigurieren

[www.teamitaliailluminazione.it](http://www.teamitaliailluminazione.it)



C 4000K



**CODICE COMPLETO DEL PRODOTTO NELLA FOTO**  
FULL PRODUCT CODE AS SHOWN IN PICTURE - VOLLSTÄNDIGER CODE VOM ARTIKEL IM BILD

**3044SOF** **NE** **24** **B**

Codice  
Code

Finitura  
Finishing  
Lackierung

Diffusore  
Diffuser  
Diffusor

Tonalità  
Hue  
Farbton

**TF** Taglio di Fase - Phase-Cut Dimmer - Erhältlich Phasenabschrittdimmer

**A** Alimentatore Incorporato - Incorporated Power Supply - Eingebautes Netzteil

\* 680lm effettivi - effective - effektive con - with - mit **24**



# TABLET ROUND

PLAFONE  
CEILING LIGHT  
DECKENLEUCHTE



configurazione standard: / basic configuration: / Standard Konfiguration:

BV

GU10

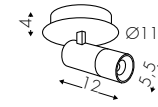

3044TBV

GU10 max 7W LED - 220V

92,00 €

Configura

Configure / Konfigurieren

[www.teamitaliailluminazione.it](http://www.teamitaliailluminazione.it)

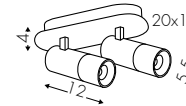

3044UBV

2xGU10 max 7W LED - 220V

174,00 €

Configura

Configure / Konfigurieren

[www.teamitaliailluminazione.it](http://www.teamitaliailluminazione.it)

NE



GU10 Sorgente non inclusa - Not included light source - Lichtquelle nicht enthalten







ON custom finish

# TABLET SQUARE

PLAFONE  
CEILING LIGHT  
DECKENLEUCHE



configurazione standard: / basic configuration: / Standard Konfiguration:

24° Ottica  
Optic - Optik

**B** 3000K

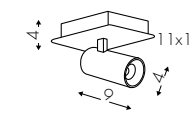

**3044MOFBV24B** 7W 680lm\* - 220V

**130,00** €

Configura Configure / Konfigurieren

[www.teamitaliailluminazione.it](http://www.teamitaliailluminazione.it)

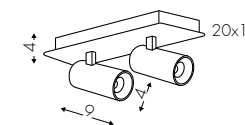

**3044NOFBV24B** 2x7W 2x680lm - 220V  
**3044NDMBV24B** DALI (Push) 2x7W 2x680lm - 220V  
**3044NTFBV24B** 2x7W 2x680lm - 220V

**244,00** €

**280,00** €

**251,00** €

Configura Configure / Konfigurieren

[www.teamitaliailluminazione.it](http://www.teamitaliailluminazione.it)

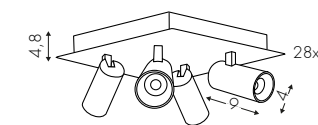

**3044FOFBV24B** 4x7W 4x680lm - 220V  
**3044FDMBV24B** DALI (Push) - 4x7W 4x680lm - 220V

**401,00** €

**445,00** €

Configura Configure / Konfigurieren

[www.teamitaliailluminazione.it](http://www.teamitaliailluminazione.it)



**C** 4000K



**CODICE COMPLETO DEL PRODOTTO NELLA FOTO**  
FULL PRODUCT CODE AS SHOWN IN PICTURE - VOLLSTÄNDIGER CODE VOM ARTIKEL IM BILD

**3044FOF** **ON** **24** **B**

Codice  
Code

Finitura  
Finishing  
Lackierung

Diffusore  
Diffuser  
Diffusor

Tonalità  
Hue  
Farbton

**TF** Taglio di Fase - Phase-Cut Dimmer - Erhältlich Phasenabschnittdimmer

**A** Alimentatore Incorporato - Incorporated Power Supply - Eingebautes Netzteil

\* 680lm effettivi - effective - effektive con - with - mit 24°

# TABLET SQUARE

PLAFONE  
CEILING LIGHT  
DECKENLEUCHE



configurazione standard: / basic configuration: / Standard Konfiguration:

GU10

BV

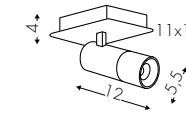

3044OBV

GU10 max 7W LED - 220V

92,00 €

Configura

Configure / Konfigurieren

[www.teamitaliailluminazione.it](http://www.teamitaliailluminazione.it)

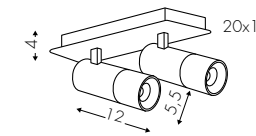

3044VBV

2xGU10 max 7W LED - 220V

174,00 €

Configura

Configure / Konfigurieren

[www.teamitaliailluminazione.it](http://www.teamitaliailluminazione.it)

NE



GU10 Sorgente non inclusa - Not included light source - Lichtquelle nicht enthalten

CODICE COMPLETO DEL PRODOTTO NELLA FOTO  
FULL PRODUCT CODE AS SHOWN IN PICTURE - VOLLSTÄNDIGER CODE VOM ARTIKEL IM BILD

**3044O**

Codice  
Code

**NE**

Finitura  
Finishing  
Lackierung



INDEX

SECTION

FAMILY 255



configurazione standard: / basic configuration: / Standard Konfiguration:

38° Offica  
Optic - Optik

● B 3000K

BV

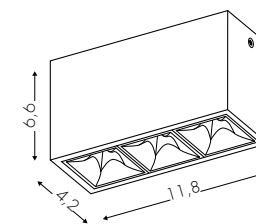

**3048COFBV38B** 10W 960lm\* - 220V

**125,00 €**

Configura Configura / Konfigurieren

[www.teamitaliailluminazione.it](http://www.teamitaliailluminazione.it)

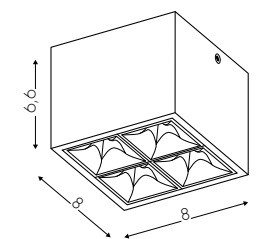

**3048DOFBV38B** 12W - 1200lm - 220V

**163,00 €**

Configura Configura / Konfigurieren

[www.teamitaliailluminazione.it](http://www.teamitaliailluminazione.it)



NE

**A** Alimentatore Incorporato - Incorporated power supply - Eingebautes Netzteil

\* 960lm effettivi - effective - effektive con - with - mit **38°**



**CODICE COMPLETO DEL PRODOTTO NELLA FOTO**  
FULL PRODUCT CODE AS SHOWN IN PICTURE - VOLLSTÄNDIGER CODE VOM ARTIKEL IM BILD

**3048COF** **BV** **38** **B**

Codice  
Code

Finitura  
Finishing  
Lackierung

Diffusore  
Diffuser  
Diffusor

Tonalità  
Hue  
Farbton







configurazione standard: / basic configuration: / Standard Konfiguration:

E28 Satinato  
Frosted - Satiniert ● B 3000K BV

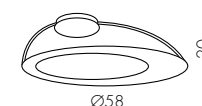

<b>3038AOFBVE28B</b>	25W 3700lm* - 220V	<b>644,00 €</b>
<b>3038ADMBVE28B</b>	DALI (Push) - 25W 3700lm - 220V	<b>692,00 €</b>
<b>3038ATFBVE28B</b>	25W 3700lm - 220V	<b>692,00 €</b>

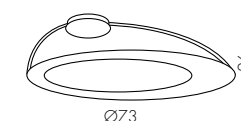

<b>3038BOFBVE28B</b>	50W 6400lm - 220V	<b>752,00 €</b>
<b>3038BDMBVE28B</b>	DALI (Push) - 50W 6400lm - 220V	<b>836,00 €</b>
<b>3038BTFBVE28B</b>	50W 6400lm - 220V	<b>836,00 €</b>

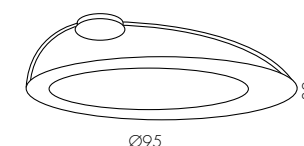

<b>3038COFBVE28B</b>	75W 7800lm - 220V	<b>860,00 €</b>
<b>3038CDMBVE28B</b>	DALI (Push) - 75W 7800lm - 220V	<b>948,00 €</b>
<b>3038CBTVE28B</b>	Bluetooth 75W 7800lm - 220V	<b>948,00 €</b>

Configura Configura / Konfigurieren

[www.teamitaliailluminazione.it](http://www.teamitaliailluminazione.it)



● A 2700K



**CODICE COMPLETO DEL PRODOTTO NELLA FOTO**  
FULL PRODUCT CODE AS SHOWN IN PICTURE - VOLLSTÄNDIGER CODE VOM ARTIKEL IM BILD

**3038COF** **BV** **E28** **B**

Codice Code	Finitura Finishing Lackierung	Diffusore Diffuser Diffusor	Tonalità Hue Farbton
----------------	-------------------------------------	-----------------------------------	----------------------------

**TF** Taglio di Fase - Phase-Cut Dimmer - Phasenabschnittdimmer  
**A** Alimentatore Incorporato - Incorporated Power Supply - Eingebautes Netzteil  
**BT** Bluetooth - Bluetooth - Bluetooth

\* 3700lm effettivi - effective - effektive con - with - mit **E28**





PIANTANA  
FLOOR LAMP  
STEHLAMPE





**Curve** 265  
laterale H185



**Riflessa** 277  
laterale H180



**Riflessa** 277  
laterale H180 + spotlight



**Edge** 267  
downlight H204xL92



**Edge** 267  
downlight/uplight H204xL92



**Edge** 267  
2x downlight H204xL152

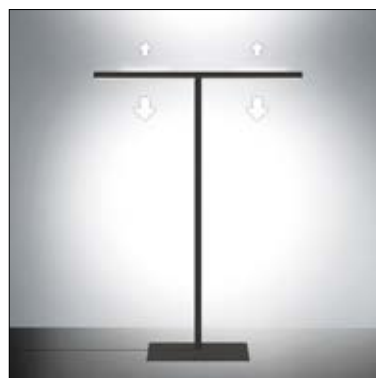

**Edge** 267  
2x downlight/uplight H204xL152



**Lambda** 269  
uplight H195



**Lambda** 271  
downlight H195x82



**Lambda** 273  
downlight H195x190



**Overlap** 275  
orientabile H185





# CURVE

PIANTANA  
FLOOR LAMP  
STEHLAMP 

configurazione standard: / basic configuration: / Standard Konfiguration:

E2 Opale - Opal

 B 3000K

BV



5022MDMBVE2B

DIM (Push) - 62W 5100lm\* - 220V

726,00 €

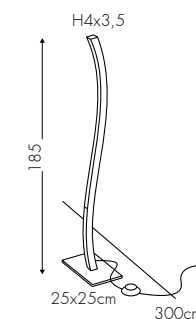

Configura 

Configure / Konfigurieren

[www.teamitaliailluminazione.it](http://www.teamitaliailluminazione.it) 



 A 2700K

NE RU 

 Alimentatore Incorporato - Incorporated Power Supply - Eingebautes Netzteil

\* 5100lm effettivi - effective - effektive con - with - mit E2

 CODICE COMPLETO DEL PRODOTTO NELLA FOTO  
FULL PRODUCT CODE AS SHOWN IN PICTURE - VOLLSTÄNDIGER CODE VOM ARTIKEL IM BILD

**5022MDM** **NE** **E2** **B**

Codice  
Code

Finitura  
Finishing  
Lackierung

Diffusore  
Diffuser  
Diffusor



Tonalità  
Hue  
Farbton



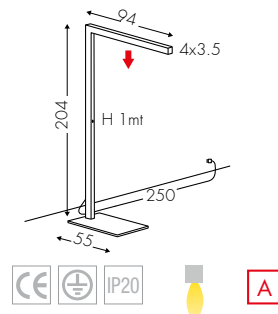

configurazione standard: / basic configuration: / Standard Konfiguration:

E19 UGR<19 Prism ● B 3000K BV



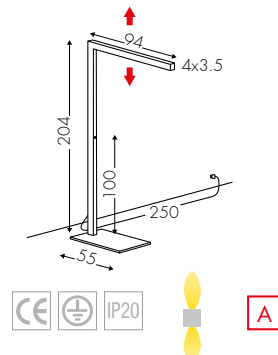

**5028BDMBVE19B** DIM (Push) - 51W 4400lm\* - 220V **925,00 €**  
[Configura](#)  Configure / Konfigurieren [www.teamitaliailluminazione.it](http://www.teamitaliailluminazione.it) 



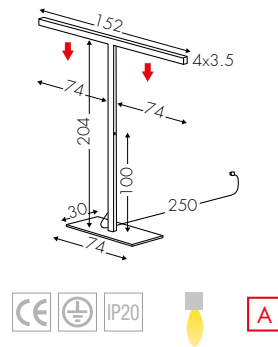

**5028CDMBVE19B** DIM (Push) - down 51W 4400lm - up 20W 2200lm - 220V **955,00 €**  
[Configura](#)  Configure / Konfigurieren [www.teamitaliailluminazione.it](http://www.teamitaliailluminazione.it) 

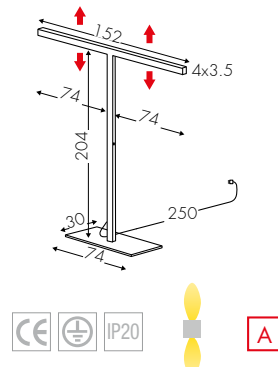

**5028DDMBVE19B** DIM (Push) - down 2x32W 2x3500lm **1.530,00 €**  
[Configura](#)  Configure / Konfigurieren [www.teamitaliailluminazione.it](http://www.teamitaliailluminazione.it) 



**5028EDMBVE19B** DIM (Push) - down 2x32W 2x3500lm - up 2x12W 2x1200lm **1.730,00 €**  
[Configura](#)  Configure / Konfigurieren [www.teamitaliailluminazione.it](http://www.teamitaliailluminazione.it) 

● A 2700K ○ C 4000K

NE RU 

A Alimentatore Incorporato - Incorporated Power Supply - Eingebautes Netzteil

\* 4400lm effettivi - effective - effektive con - with - mit **E19**

 **CODICE COMPLETO DEL PRODOTTO NELLA FOTO**  
**FULL PRODUCT CODE AS SHOWN IN PICTURE - VOLLSTÄNDIGER CODE VOM ARTIKEL IM BILD**

<b>5028BDM</b>	<b>NE</b>	<b>E19</b>	<b>B</b>
Codice Code	Finitura Finishing Lackierung	Diffusore Diffuser Diffusor	Tonalità Hue Farbton

# LAMBDA

PIANTANA  
FLOOR LAMP  
STEHLAMP 

configurazione standard: / basic configuration: / Standard Konfiguration:

E2 Opale - Opal  B 3000K 

**5071EDPONE2B** 35W 3800lm\* - 220V **680,00 €**

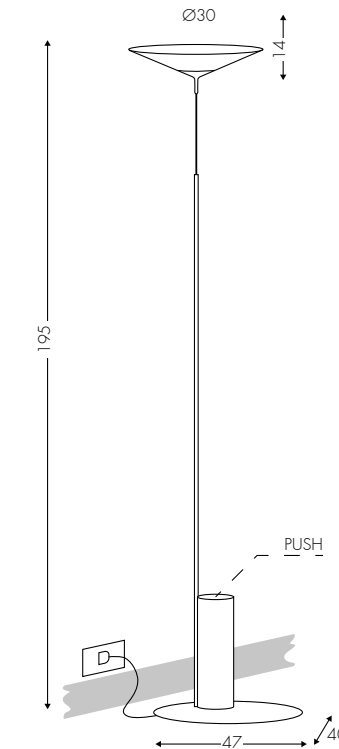

Configura  Configure / Konfigurieren

[www.teamitaliailluminazione.it](http://www.teamitaliailluminazione.it) 

 A 2700K 

 **CODICE COMPLETO DEL PRODOTTO NELLA FOTO**  
FULL PRODUCT CODE AS SHOWN IN PICTURE - VOLLSTÄNDIGER CODE VOM ARTIKEL IM BILD

**5071EDP** **ZN** **E2** **B**



Codice  
Code

Finitura  
Finishing  
Lackierung

Diffusore  
Diffuser  
Diffusor

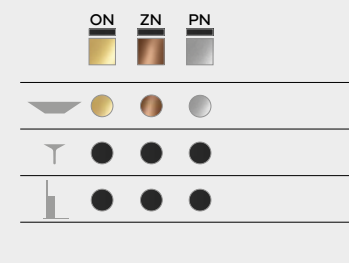
Tonalità  
Hue  
Farbton



 Alimentatore Incorporato - Incorporated Power Supply - Eingebautes Netzteil  
 Dim Push

\* 3800lm effettivi - effective - effektive con - with - mit **E2**



# LAMBDA

PIANTANA  
FLOOR LAMP  
STEHLAMP 



configurazione standard: / basic configuration: / Standard Konfiguration:

E2 Opale - Opal  B 3000K 

5071CDPONE2B 9W 1200lm\* - 220V

818,00 €

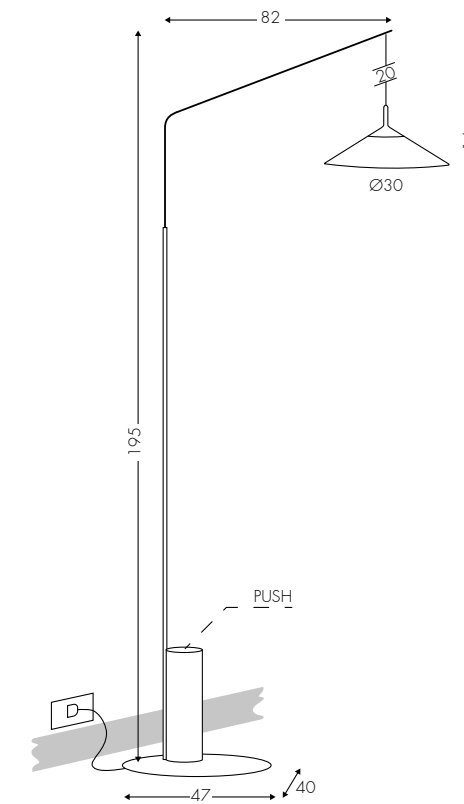

Configura  Configure / Konfigurieren

[www.teamitaliailluminazione.it](http://www.teamitaliailluminazione.it) 



 A 2700K 

 CODICE COMPLETO DEL PRODOTTO NELLA FOTO  
FULL PRODUCT CODE AS SHOWN IN PICTURE - VOLLSTÄNDIGER CODE VOM ARTIKEL IM BILD

**5071CDP** **ON** **E2** **B**

Codice  
Code

Finitura  
Finishing  
Lackierung

Diffusore  
Diffuser  
Diffusor

Tonalità  
Hue  
Farbton

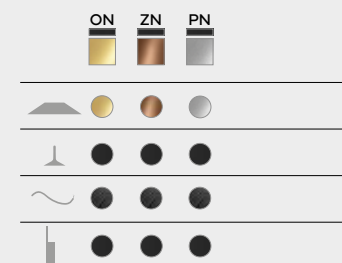

**A** Alimentatore Incorporato - Incorporated Power Supply - Eingebautes Netzteil  
**DP** Dim Push

\* 1200lm effettivi - effective - effektive con - with - mit **E2**



# LAMBDA

PIANTANA  
FLOOR LAMP  
STEHLAMP

configurazione standard: / basic configuration: / Standard Konfiguration:

E2 Opale - Opal B 3000K

5071DDPONE2B 9W 1200lm\* - 220V

1.070,00 €

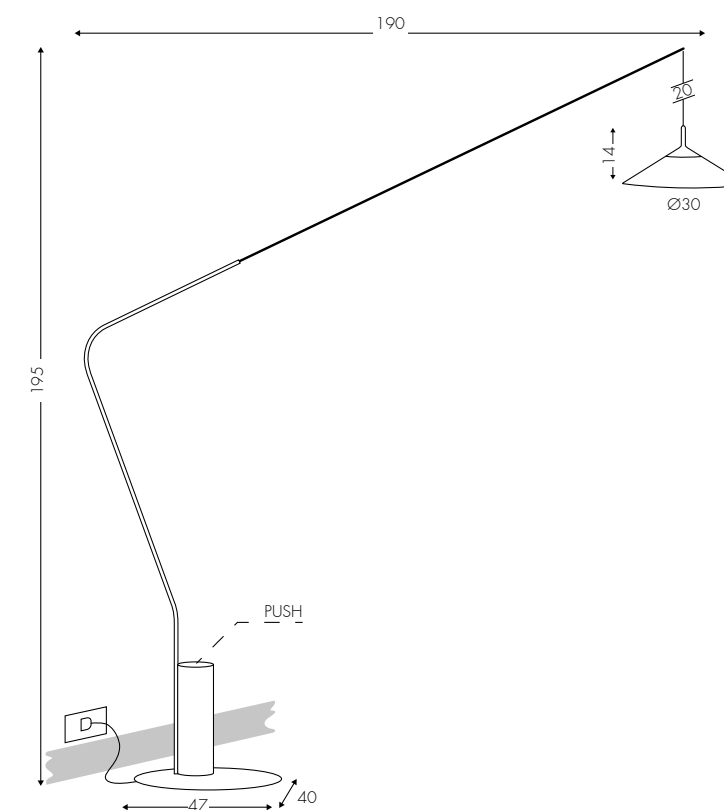

Configura Configure / Konfigurieren

[www.teamitaliailluminazione.it](http://www.teamitaliailluminazione.it)

A 2700K

CODICE COMPLETO DEL PRODOTTO NELLA FOTO  
FULL PRODUCT CODE AS SHOWN IN PICTURE - VOLLSTÄNDIGER CODE VOM ARTIKEL IM BILD

**5071DDP** **PN** **E2** **B**

Codice  
Code

Finitura  
Finishing  
Lackierung

Diffusore  
Diffuser  
Diffusor

Tonalità  
Hue  
Farbton

Alimentatore Incorporato - Incorporated Power Supply - Eingebautes Netzteil  
 Dim Push

\* 1200lm effettivi - effective - effektive con - with - mit E2

# OVERLAP

PIANTANA  
FLOOR LAMP  
STEHLAMP



configurazione standard: / basic configuration: / Standard Konfiguration:

E2 Opale - Opal

B 3000K

BV



5015AOFBVE2B

52W 3645lm\* - 220V

526,00 €

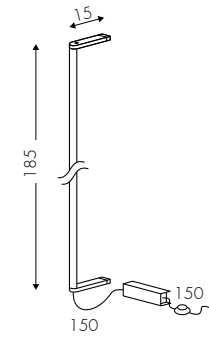

5015ADMBVE2B

DIM (RF) - 52W 3645lm - 220V

668,00 €

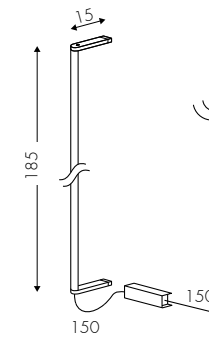

C005T2BV

Custom white cable

8,00 € /MT

C005T2RO

Custom red cable

8,00 € /MT

Configura

Configure / Konfigurieren

[www.teamitaliailluminazione.it](http://www.teamitaliailluminazione.it)



A 2700K

BV



A Alimentatore nel rosone - Power Supply inside the ceiling rose - Netzteil in der Deckendose

\* 3645lm effettivi - effective - effektive con - with - mit E2

CODICE COMPLETO DEL PRODOTTO NELLA FOTO  
FULL PRODUCT CODE AS SHOWN IN PICTURE - VOLLSTÄNDIGER CODE VOM ARTIKEL IM BILD

**5015ADM** **BV** **E2** **B** + **C005T2RO**

Codice  
Code

Finitura  
Finishing  
Lackierung

Diffusore  
Diffuser  
Diffusor

Tonalità  
Hue  
Farbton

Codice  
Code

custom RED CABLE

BV

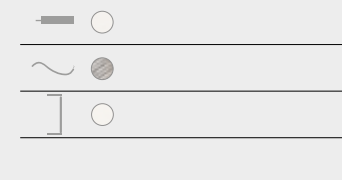

INDEX

SECTION

FAMILY 275



# RIFLESSA

PIANTANA  
FLOOR LAMP  
STEHLAMP



configurazione standard: / basic configuration: / Standard Konfiguration:

**E28** Satinato  
Frosted - Satinert

**B** 3000K



**5052ADM**BVE28B

DIM (Push) - 37W 4500lm\* - 220V

**837,00 €**

**5052ABT**BVE28B

Bluetooth 37W 4500lm - 220V

**948,00 €**

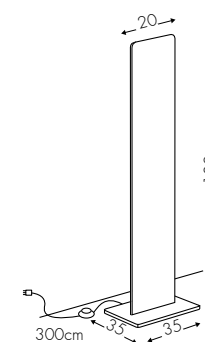

Configura

Configure / Konfigurieren

[www.teamitaliailluminazione.it](http://www.teamitaliailluminazione.it)



**A** 2700K



configurazione standard: / basic configuration: / Standard Konfiguration:

**E28** Satinato - Frosted - Satinert  
**24°** Ottica - Optic - Optik

**B** 3000K



**5054ADM**BVE28B

DIM (Push) - 37W 4500lm + 1x13W 1x1300lm - 220V

**948,00 €**

**5054ABT**BVE28B

Bluetooth 37W 4500lm + 1x13W 1x1300lm - 220V

**1.059,00 €**

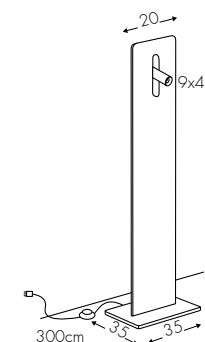

Configura

Configure / Konfigurieren

[www.teamitaliailluminazione.it](http://www.teamitaliailluminazione.it)



**A** 2700K

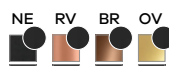

**CODICE COMPLETO DEL PRODOTTO NELLA FOTO**  
FULL PRODUCT CODE AS SHOWN IN PICTURE - VOLLSTÄNDIGER CODE VOM ARTIKEL IM BILD

**5054ADM** **OV** **E28** **B**

Codice  
Code

Finitura  
Finishing  
Lackierung

Diffusore  
Diffuser  
Diffusor

Tonalità  
Hue  
Farbton

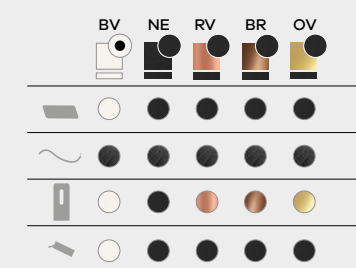

**A** Alimentatore Incorporato - Incorporated Power Supply - Eingebautes Netzteil

**BT** Bluetooth - Bluetooth - Bluetooth

\* 4500lm effettivi - effective - effektive con - with - mit **E28**

INDEX

SECTION

FAMILY 277

# Incassi/recessed Einbauleuchte





**Bellai Home** 285  
downlight cartongesso Ø58/Ø95

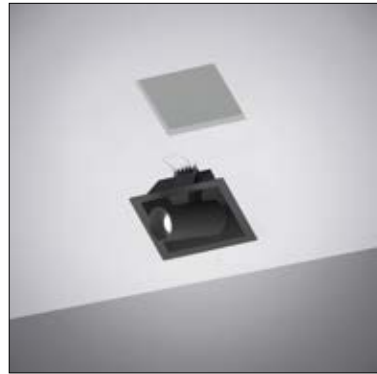

**Operà** 297  
orientabile cartongesso - 1x7W



**Operà** 297  
orientabile cartongesso - 2x7W



**Operà** 297  
orientabile cartongesso - 3x7W



**Operà** 299  
orientabile cartongesso - 2x7W +25W



**Operà** 299  
orientabile cartongesso - 2x7W +25W



**Retrò** 301  
downlight cartongesso L23/L37/L65



**Micro** 295  
orientabile cartongesso Ø10 - 1x3W



**Micro** 295  
orientabile cartongesso Ø10 - 2x3W



**S-Pot** 311  
downlight cartongesso/muratura Ø12,5 - 13W



**Side** 303  
downlight cartongesso 9,5x9,5 - 13W



**Side** 303  
downlight cartongesso Ø9 - 13W



**S-Pot** 307  
downlight cartongesso 8x8 - 9W



**S-Pot** 305  
downlight cartongesso Ø9 - 9W



**S-Pot** 305  
downlight cartongesso Ø15 - 18W /26W



**Expo** 289  
downlight cartongesso Ø14 18W/Ø20 36W



**S-Pot** 313  
downlight cartongesso Ø4 - 4W



**S-Pot** 313  
downlight cartongesso Ø6 - 9W



**S-Pot** 313  
downlight cartongesso Ø7 - 13,5W



**S-Pot** 309  
downlight cartongesso Ø5 - 7W





**Tablet Round** 314  
orientabile cartongesso 1x7W GU10



**Tablet Round** 314  
orientabile cartongesso 2x7W GU10



**Tablet Round** 315  
orientabile cartongesso 1x7W



**Tablet Round** 315  
orientabile cartongesso 2x7W



**Tablet Round** 315  
orientabile cartongesso 1x13W



**Tablet Square** 316  
orientabile cartongesso 1x7W GU10



**Tablet Square** 316  
orientabile cartongesso 2x7W GU10

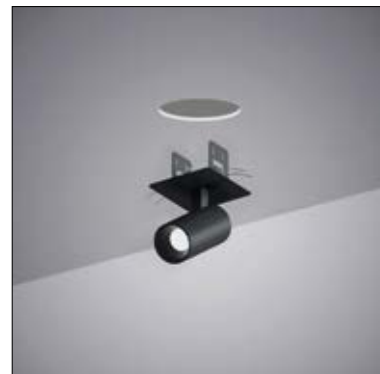

**Tablet Square** 317  
orientabile cartongesso 1x7W



**Tablet Square** 317  
orientabile cartongesso 2x7W



**Tablet Square** 317  
orientabile cartongesso 1x13W

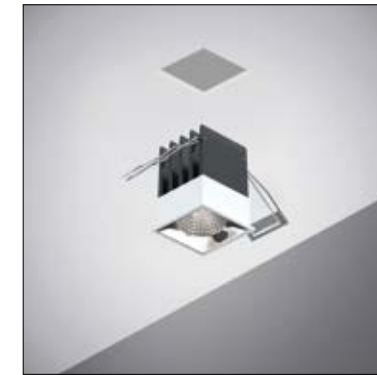

**Task** 319  
downlight cartongesso L4,5x4,5 - 4W

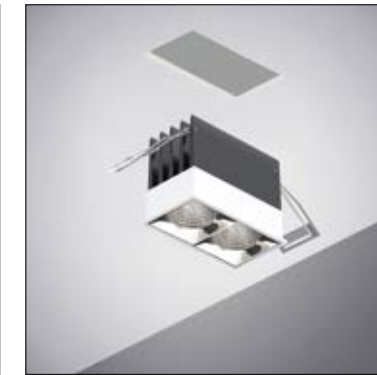

**Task** 319  
downlight cartongesso L4,5x8 - 7,5W

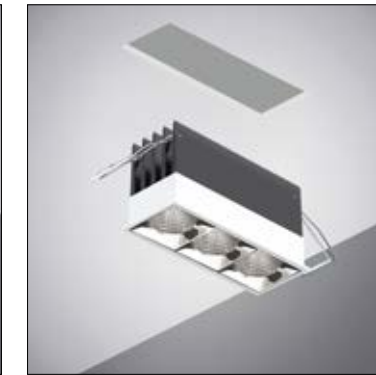

**Task** 319  
downlight cartongesso L4,5x11,5 - 15W

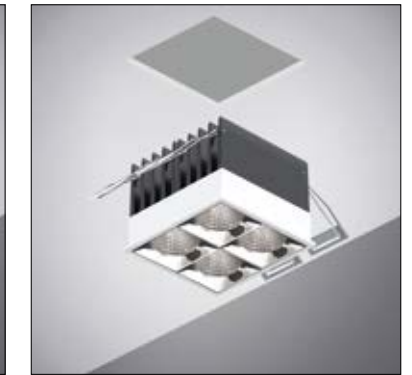

**Task** 319  
downlight cartongesso L8x8 - 18W



**Bulbe** 287  
downlight Ø15/Ø20 versione singola



**Lambda** 291  
downlight versione singola incasso Ø20/Ø30



**Venis** 323  
downlight Ø20 incasso



**Licis** 293  
downlight Ø20 incasso



**Tubico** 321  
downlight versione singola incasso 1x



**Tubico** 321  
downlight composizione incasso 2x



configurazione standard: / basic configuration: / Standard Konfiguration:

E2 Opale - Opal - Opal ● B 3000K

BV

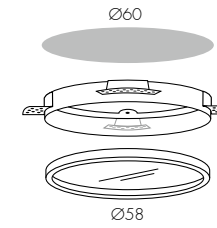

<b>4027EOFBVE2B</b>	45W 3230lm* - 220V	<b>897,00</b> €
<b>4027EDMBVE2B</b>	DALI (Push) - 45W 3230lm - 220V	<b>981,00</b> €
<b>4027ETFBVE2B</b>	45W 3230lm - 220V	<b>981,00</b> €

Configura Configure / Konfigurieren

[www.teamitaliailluminazione.it](http://www.teamitaliailluminazione.it) NE RU

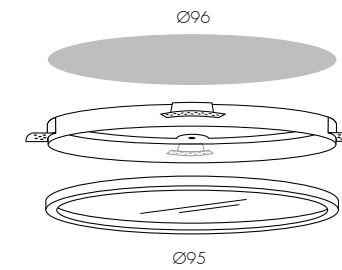

<b>4027FOFBVE2B</b>	65W 5168lm - 220V	<b>1.230,00</b> €
<b>4027FDMBVE2B</b>	DALI (Push) - 65W 5168lm - 220V	<b>1.315,00</b> €
<b>4027FBTBVE2B</b>	Bluetooth 65W 5168lm - 220V	<b>1.315,00</b> €

Configura Configure / Konfigurieren

[www.teamitaliailluminazione.it](http://www.teamitaliailluminazione.it) NE RU



● A 2700K



**CODICE COMPLETO DEL PRODOTTO NELLA FOTO**  
FULL PRODUCT CODE AS SHOWN IN PICTURE - VOLLSTÄNDIGER CODE VOM ARTIKEL IM BILD

**4027EOF** **BV** **E2** **B**

Codice Code	Finitura Finishing Lackierung	Diffusore Diffuser Diffusor	Tonalità Hue Farbton
----------------	-------------------------------------	-----------------------------------	----------------------------

**BT** Bluetooth - Bluetooth - Bluetooth  
**A** Alimentatore Incorporato - Incorporated Power Supply - Eingebautes Netzteil

\* 3230lm effettivi - effective - effektive con - with - mit **E2**



# BULBE

INCASSO  
RECESSED LIGHT  
EINBAULEUCHTE



configurazione standard: / basic configuration: / Standard Konfiguration:

GU10



4078A0B

1x GU10 max 7W LED - 220V

240,00 €

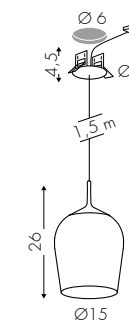

4078B0B

1x GU10 max 7W LED - 220V

275,00 €

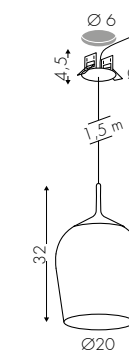

Configura

Configure / Konfigurieren

[www.teamitaliailluminazione.it](http://www.teamitaliailluminazione.it)



CODICE COMPLETO DEL PRODOTTO NELLA FOTO  
FULL PRODUCT CODE AS SHOWN IN PICTURE - VOLLSTÄNDIGER CODE VOM ARTIKEL IM BILD

**4078B**

Codice  
Code

**ZN**

Finitura  
Finishing  
Lackierung

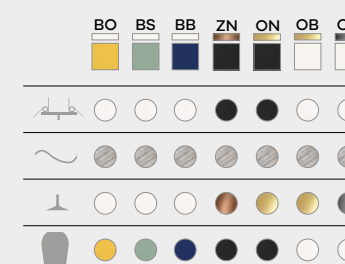

GU10 Sorgente GU10 non inclusa - GU10 light source not included - GU10 Lichtquelle nicht enthalten

INDEX

SECTION

FAMILY 287





configurazione standard: / basic configuration: / Standard Konfiguration:

Ottica 45° (45)

B 3000K

BV

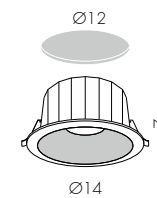

**4089BOFBV45B**  
**4089BDMBV45B**

18W 1674lm\* - 220V  
DALI (Push) - 18W 1674lm - 220V

**53,00 €**  
**98,00 €**

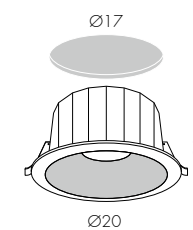

**4089COFBV45B**  
**4089CDMBV45B**

36W 2800lm - 220V  
DALI (Push) - 36W 2800lm - 220V

**99,00 €**  
**144,00 €**

Configura

Configure / Konfigurieren

[www.teamitaliailluminazione.it](http://www.teamitaliailluminazione.it)



C 4000K

BV



Alimentatore incluso in remoto - Included Power Supply in remote - Fernspeisung enthalten

\* 1674lm effettivi - effective - effektive con - with - mit E2

**CODICE COMPLETO DEL PRODOTTO NELLA FOTO**  
FULL PRODUCT CODE AS SHOWN IN PICTURE - VOLLSTÄNDIGER CODE VOM ARTIKEL IM BILD

**4089COF** **BV** **45** **B**

Codice  
Code

Finitura  
Finishing  
Lackierung

Diffusore  
Diffuser  
Diffusor

Tonalità  
Hue  
Farbton



# LAMBDA

INCASSO  
RECESSED LIGHT  
EINBAULEUCHTE



configurazione standard: / basic configuration: / Standard Konfiguration:

E19 Prismatico - Prism ● B 3000K



**4071PTFONE19B** 6,5W 800lm\* - 220V

**306,00 €**

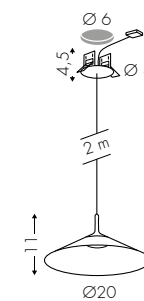

**4071QTFONE19B** 6,5W 800lm - 220V

**386,00 €**

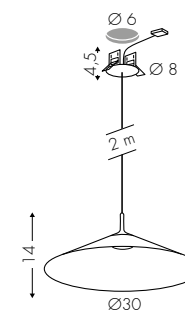

**C005A2TR** Custom transparent cable

**7,00 € /MT**

Configura Configure / Konfigurieren

[www.teamitaliailluminazione.it](http://www.teamitaliailluminazione.it)



● A 2700K



**CODICE COMPLETO DEL PRODOTTO NELLA FOTO**  
FULL PRODUCT CODE AS SHOWN IN PICTURE - VOLLSTÄNDIGER CODE VOM ARTIKEL IM BILD

**4071PTF** **ZN** **E19** **A**

Codice Code	Finitura Finishing Lackierung	Diffusore Diffuser Diffusor	Tonalità Hue Farbton
----------------	-------------------------------------	-----------------------------------	----------------------------

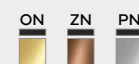

**TF** Taglio di Fase - Phase-Cut Dimmer - Phasenabschnittdimmer  
**A↑** Alimentatore incluso in remoto - Included Power Supply in remote - Fernspeisung enthalten

\* 800lm effettivi - effective - effektiven con - with - mit **E2**

INDEX

SECTION

FAMILY 291



# LICIS

INCASSO  
RECESSED LIGHT  
EINBAULEUCHTE



configurazione standard: / basic configuration: / Standard Konfiguration:

E2 Opale - Opal - Opal ● B 3000K



**4073ATF**NTE2B 6,5W 800lm\* - 220V

**350,00 €**

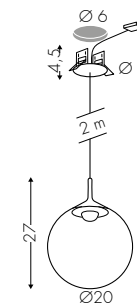

● **C005T2NE** Custom black cable

**8,00 € /MT**

Configura Configure / Konfigurieren

[www.teamitaliailluminazione.it](http://www.teamitaliailluminazione.it)



● A 2700K



**CODICE COMPLETO DEL PRODOTTO NELLA FOTO**  
FULL PRODUCT CODE AS SHOWN IN PICTURE - VOLLSTÄNDIGER CODE VOM ARTIKEL IM BILD

**4073ATF** **NT** **E2** **A**

Codice Code	Finitura Finishing Lackierung	Diffusore Diffuser Diffusor	Tonalità Hue Farbton
----------------	-------------------------------------	-----------------------------------	----------------------------

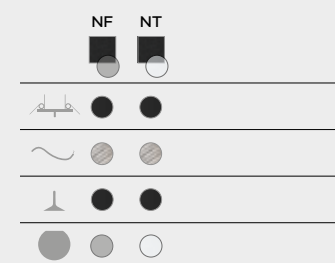

**TF** Taglio di Fase - Phase-Cut Dimmer - Phasenabschnittdimmer

**A↑** Alimentatore incluso in remoto - Included Power Supply in remote - Fernspeisung enthalten

\* 800lm effettivi - effective - effektive con - with - mit **E2**

INDEX

SECTION

FAMILY 293





# MICRO

INCASSO  
RECESSED LIGHT  
EINBAULEUCHTE



configurazione standard: / basic configuration: / Standard Konfiguration:

24° Ottica - Optic - Optik ● B 3000K

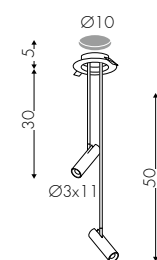
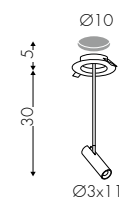

**4039ABV24B** 3W 360lm\* - 350mA - 9V **196,00 €**

Alimentatore - Power supply - Netzteil

**AE006A** OnOff 10W 350mA / 1-3 art. 4039A **16,00 €**

**AE007A** DALI (Push) 19,2W 350mA / 1-5 art. 4039A **65,00 €**

**AE008D** PHASE CUT (Dimmer) 10,5W 350mA / 1-2 art. 4039A **18,00 €**

**AE008B** PHASE CUT (Dimmer) 18W 350mA / 3-5 art. 4039A **26,00 €**

Configura

Configure / Konfigurieren

[www.teamitaliailluminazione.it](http://www.teamitaliailluminazione.it)

**4039BBV24B** 2x3W 2x360lm - 350mA - 18V **284,00 €**

Alimentatore - Power supply - Netzteil

**AE006A** OnOff 10W 350mA / 1 art. 4039B **16,00 €**

**AE007A** DALI (Push) 19,2W 350mA / 1-2 art. 4039B **65,00 €**

**AE008A** PHASE CUT (Dimmer) 10,5W 350mA / 1 art. 4039B **26,00 €**

**AE008B** PHASE CUT (Dimmer) 18W 350mA / 2 art. 4039B **26,00 €**

Configura

Configure / Konfigurieren

[www.teamitaliailluminazione.it](http://www.teamitaliailluminazione.it)



○ C 4000K



Alimentatore non incluso - Power Supply not included - Netzteil nicht inbegriffen

\* 360lm effettivi - effective - effektive con - with - mit 24°

**CODICE COMPLETO DEL PRODOTTO NELLA FOTO**  
FULL PRODUCT CODE AS SHOWN IN PICTURE - VOLLSTÄNDIGER CODE VOM ARTIKEL IM BILD

**4039A** **NE** **24** **B**

Codice Code	Finitura Finishing Lackierung	Diffusore Diffuser Diffusor	Tonalità Hue Farbton
----------------	-------------------------------------	-----------------------------------	----------------------------



configurazione standard: / basic configuration: / Standard Konfiguration:

24° Ottica - Optic - Optik ● B 3000K

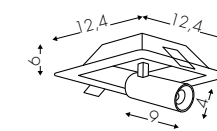

<b>4033AOFBV24B</b>	7W 680lm* - 220V	<b>174,00 €</b>
<b>4033ADMBV24B</b>	DALI (Push) - 7W 680lm - 220V	<b>213,00 €</b>
<b>4033ATFBV24B</b>	7W 680lm - 220V	<b>190,00 €</b>

Configura Configure / Konfigurieren

[www.teamitaliailluminazione.it](http://www.teamitaliailluminazione.it)

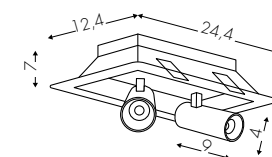

<b>4033BOFBV24B</b>	2x7W 2x680lm - 220V	<b>268,00 €</b>
<b>4033BDMBV24B</b>	DALI (Push) - 2x7W 2x680lm - 220V	<b>308,00 €</b>
<b>4033BTFBV24B</b>	2x7W 2x680lm - 220V	<b>277,00 €</b>

Configura Configure / Konfigurieren

[www.teamitaliailluminazione.it](http://www.teamitaliailluminazione.it)

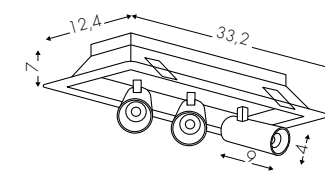

<b>4033COFBV24B</b>	3x7W 3x680lm - 220V	<b>323,00 €</b>
<b>4033CDMBV24B</b>	DALI (Push) - 3x7W 3x680lm - 220V	<b>374,00 €</b>
<b>4033CTFBV24B</b>	3x7W 3x680lm - 220V	<b>359,00 €</b>

Configura Configure / Konfigurieren

[www.teamitaliailluminazione.it](http://www.teamitaliailluminazione.it)



C 4000K



**TF** Taglio di Fase - Phase-Cut Dimmer - Erhältlich Phasenabschnittdimmer

**A↑** Alimentatore Incluso in remoto - Included Power Supply in remote - Fernspeisung enthalten

\* 680lm effettivi - effective - effektive con - with - mit 24°



**CODICE COMPLETO DEL PRODOTTO NELLA FOTO**  
FULL PRODUCT CODE AS SHOWN IN PICTURE - VOLLSTÄNDIGER CODE VOM ARTIKEL IM BILD

**4033BOF** **ON** **24** **B**

Codice Code	Finitura Finishing Lackierung	Diffusore Diffuser Diffusor	Tonalità Hue Farbton
----------------	-------------------------------------	-----------------------------------	----------------------------





configurazione standard: / basic configuration: / Standard Konfiguration:

+ E2 Opale - Opal  
24° Ottica - Optic - Optik ● B 3000K

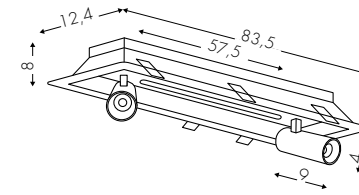

<b>4033EOFBV24B</b>	25W 2860lm* + 2x7W 2x680lm - 220V	<b>347,00 €</b>
<b>4033EDMBV24B</b>	DALI (Push) - 25W 2860lm + 2x7W 2x680lm - 220V	<b>414,00 €</b>
<b>4033ETFBV24B</b>	25W 2860lm + 2x7W 2x680lm - 220V	<b>374,00 €</b>

Configura Configure / Konfigurieren

[www.teamitaliailluminazione.it](http://www.teamitaliailluminazione.it)

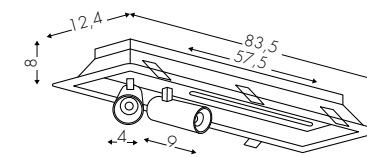

<b>4033FOFBV24B</b>	25W 2860lm + 2x7W 2x680lm - 220V	<b>347,00 €</b>
<b>4033FDMBV24B</b>	DALI (Push) - 25W 2860lm + 2x7W 2x680lm - 220V	<b>414,00 €</b>
<b>4033FTFBV24B</b>	25W 2860lm + 2x7W 2x680lm - 220V	<b>374,00 €</b>

Configura Configure / Konfigurieren

[www.teamitaliailluminazione.it](http://www.teamitaliailluminazione.it)



C 4000K



**CODICE COMPLETO DEL PRODOTTO NELLA FOTO**  
FULL PRODUCT CODE AS SHOWN IN PICTURE - VOLLSTÄNDIGER CODE VOM ARTIKEL IM BILD

**4033FOF** **NE** **24** **B**

Codice  
Code

Finitura  
Finishing  
Lackierung

Diffusore  
Diffuser  
Diffusor

Tonalità  
Hue  
Farbton

**TF** Taglio di Fase - Phase-Cut Dimmer - Erhältlich Phasenabschrittdimmer

**A↑** Alimentatore Incluso in remoto - Included Power Supply in remote - Fernspeisung enthalten

\* 2860lm effettivi - effective - effektive con - with - mit 24°





# RETRO

INCASSO  
RECESSED LIGHT  
EINBAULEUCHTE



configurazione standard: / basic configuration: / Standard Konfiguration:

E19 UGR<19 Prism

B 3000K

BV

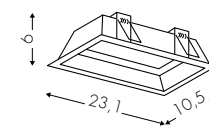

**4041GOFBVE19B**  
**4041GDMBVE19B**  
**4041GTFBVE19B**

15W - 1800lm\* - 220V  
DALI(Push) 15W - 1800lm - 220V  
(TAGLIO DI FASE) 15W - 1800lm - 220V

**186,00 €**  
**223,00 €**  
**223,00 €**

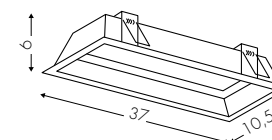

**4041HOFBVE19B**  
**4041HDMBVE19B**  
**4041HTFBVE19B**

25W - 3300lm - 220V  
DALI(Push) 25W - 3300lm - 220V  
(TAGLIO DI FASE) 25W - 3300lm - 220V

**227,00 €**  
**266,00 €**  
**266,00 €**

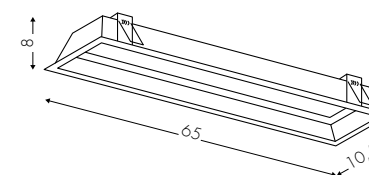

**4041IOFBVE19B**  
**4041IDMBVE19B**

50W - 6000lm - 220V  
DALI(Push) 50W - 6000lm - 220V

**290,00 €**  
**340,00 €**

Configura

Configure / Konfigurieren

[www.teamitaliailluminazione.it](http://www.teamitaliailluminazione.it)



A 2700K  C 4000K

NE



**CODICE COMPLETO DEL PRODOTTO NELLA FOTO**  
FULL PRODUCT CODE AS SHOWN IN PICTURE  
VOLLSTÄNDIGER CODE VOM ARTIKEL IM BILD

**4041GOF** **NE** **E19** **B**

Codice  
Code

Finitura  
Finishing  
Lackierung

Diffusore  
Diffuser  
Diffusor

Tonalità  
Hue  
Farbton

**TF** Taglio di Fase - Phase-Cut Dimmer - Phasenabschrittdimmer

**A↑** Alimentatore Incluso remoto - Included Power Supply in remote - Fernspeisung enthalten

\* 1800lm effettivi - effective - effektive con - with - mit **E19**

INDEX

SECTION

FAMILY 301

# SIDE

INCASSO  
RECESSED LIGHT  
EINBAULEUCHTE



configurazione standard: / basic configuration: / Standard Konfiguration:

24° Ottica - Optic Optik ● B 3000K

BV

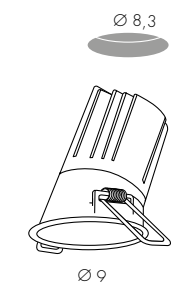
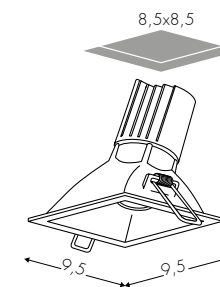

<b>4057ABV24B</b>	13W 1300lm* - 350mA 36V	<b>103,00 €</b>
Alimentatore - Power supply - Netzteil		
<b>AE006B</b>	OnOff 16W 350mA / 1 art. 4057A	<b>28,00 €</b>
<b>AE007A</b>	DALI (Push) 19,2W 350mA / 1 art. 4057A	<b>65,00 €</b>
<b>AE008B</b>	PHASE CUT (Dimmer) 18W 350mA / 1 art. 4057A	<b>26,00 €</b>

Configura Configure / Konfigurieren

[www.teamitaliailluminazione.it](http://www.teamitaliailluminazione.it)

<b>4057BBV24B</b>	10W 1300lm - 500mA 20V	<b>103,00 €</b>
Alimentatore - Power supply - Netzteil		
<b>AE006F</b>	OnOff 20W 500mA / 1 art. 4057B	<b>27,00 €</b>
<b>AE007B</b>	DALI (Push) 25W 500mA / 1 art. 4057B	<b>62,00 €</b>
<b>AE008F</b>	PHASE CUT (Dimmer) 20W 500mA / 1 art. 4057B	<b>44,00 €</b>

Configura Configure / Konfigurieren

[www.teamitaliailluminazione.it](http://www.teamitaliailluminazione.it)



Alimentatore non incluso - Power supply not included - Netzteil nicht inbegriffen

\* 1300lm effettivi - effective - effektive con - with - mit 24°



**CODICE COMPLETO DEL PRODOTTO NELLA FOTO**  
FULL PRODUCT CODE AS SHOWN IN PICTURE  
VOLLSTÄNDIGER CODE VOM ARTIKEL IM BILD

**4057A** **BV** **24** **B**

Codice Code	Finitura Finishing Lackierung	Diffusore Diffuser Diffusor	Tonalità Hue Farbton
----------------	-------------------------------------	-----------------------------------	----------------------------







# S-POT

INCASSO  
RECESSED LIGHT  
EINBAULEUCHE



configurazione standard: / basic configuration: / Standard Konfiguration:

36° Ottica - Optic - Optik ● B 3000K

BV

**4017IOFBV36B** 9W 1000lm\* - 220V 103,00 €  
**4017ITFBV36B** 9W 1000lm - 220V 129,00 €

Configura Configure / Konfigurieren

[www.teamitaliailluminazione.it](http://www.teamitaliailluminazione.it)

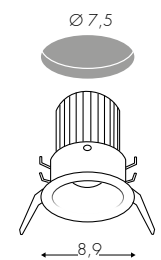

**4017LOFBV36B** 18W 2000lm - 220V 150,00 €  
**4017LTFBV36B** 18W 2000lm - 220V 177,00 €

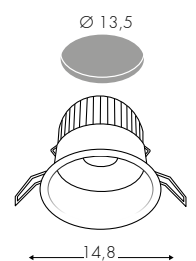

**4017MOFBV36B** 26W 3000lm - 220V 160,00 €  
**4017MTFBV36B** 26W 3000lm - 220V 187,00 €

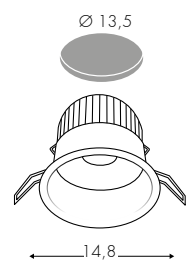

Configura Configure / Konfigurieren

[www.teamitaliailluminazione.it](http://www.teamitaliailluminazione.it)



○ C 4000K

NE

**CODICE COMPLETO DEL PRODOTTO NELLA FOTO**  
**FULL PRODUCT CODE AS SHOWN IN PICTURE - VOLLSTÄNDIGER CODE VOM ARTIKEL IM BILD**

**4017LOF** **NE** **36** **B**

Codice  
Code

Finitura  
Finishing  
Lackierung

Diffusore  
Diffuser  
Diffusor

Tonalità  
Hue  
Farbton



**TF** Taglio di Fase - Phase-Cut Dimmer - Erhältlich Phasenabschnittdimmer

**A↑** Alimentatore Incluso in remoto - Included Power Supply in remote - Fernspeisung enthalten

\* 1000lm effettivi - effective - effektive con - with - mit 36°



# S-POT

INCASSO  
RECESSED LIGHT  
EINBAULEUCHTE



configurazione standard: / basic configuration: / Standard Konfiguration:

36° Ottica - Optic - Optik ● B 3000K

BV

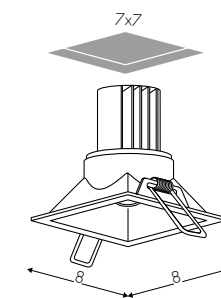

**4017NBV36B**

Max 9W 1000lm - 350mA 30V

**103,00 €**

Alimentatore - Power supply - Netzteil

**AE006A**

OnOff 10W 350mA / 1 art. 4017N

**16,00 €**

**AE007A**

DALI (Push) 19,2W 350mA / 1 art. 4017N

**65,00 €**

**AE008D**

PHASE CUT (Dimmer) 10W 350mA / 1 art. 4017N

**18,00 €**

Configura

Configure / Konfigurieren

[www.teamitaliailluminazione.it](http://www.teamitaliailluminazione.it)



C 4000K

Alimentatore non incluso - Power Supply not included - Netzteil nicht inbegriffen

\* 1000lm effettivi - effective - effektive con - with - mit 36°

CODICE COMPLETO DEL PRODOTTO NELLA FOTO  
FULL PRODUCT CODE AS SHOWN IN PICTURE - VOLLSTÄNDIGER CODE VOM ARTIKEL IM BILD

**4017N**

Codice  
Code

**BV**

Finitura  
Finishing  
Lackierung

**36**

Diffusore  
Diffuser  
Diffusor

**B**

Tonalità  
Hue  
Farbton

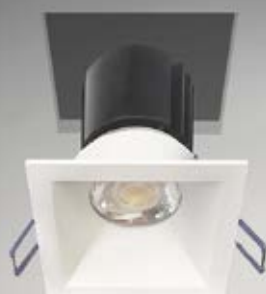

INDEX

SECTION

FAMILY 307



configurazione standard: / basic configuration: / Standard Konfiguration:

24° Ottica - Optic - Optik ● B 3000K

BV

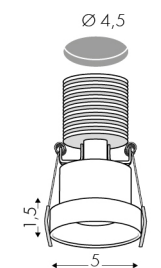

<b>4017SBV24B</b>	Max 7W 680lm* - 350mA 20V	<b>56,00 €</b>
Alimentatore - Power supply - Netzteil		
<b>AE006A</b>	OnOff 10W 350mA / 1 art. 4017S	<b>16,00 €</b>
<b>AE006B</b>	OnOff 16W 350mA / 2 art. 4017S	<b>28,00 €</b>
<b>AE007A</b>	DALI (Push) 19,2W 350mA / 1-2 art. 4017S	<b>65,00 €</b>
<b>AE008A</b>	PHASE CUT (Dimmer) 10W 350mA / 1 art. 4017S	<b>26,00 €</b>
<b>AE008B</b>	PHASE CUT (Dimmer) 18W 350mA / 1-2 art. 4017S	<b>26,00 €</b>



Configura Configure / Konfigurieren

[www.teamitaliailluminazione.it](http://www.teamitaliailluminazione.it)



**↑** CODICE COMPLETO DEL PRODOTTO NELLA FOTO  
FULL PRODUCT CODE AS SHOWN IN PICTURE  
VOLLSTÄNDIGER CODE VOM ARTIKEL IM BILD

**4017S** **OV** **24** **B**

Codice Code	Finitura Finishing Lackierung	Diffusore Diffuser Diffusor	Tonalità Hue Farbton
----------------	-------------------------------------	-----------------------------------	----------------------------

Alimentatore non incluso - Power Supply not included - Netzteil nicht inbegriffen

\* 680lm effettivi - effective - effektive con - with - mit 24°



# S-POT

INCASSO  
RECESSED LIGHT  
EINBAULEUCHTE



configurazione standard: / basic configuration: / Standard Konfiguration:

E28 Satinato - Satin - Satiniert ● B 3000K

BV



**4017TFBVE28B**

13W 1300lm\* - 220V

**185,00 €**

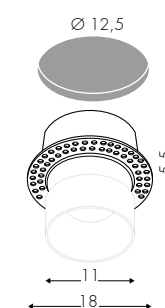
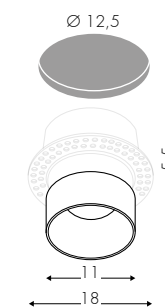

**9017F**

Controcassa - Outer Casing - Einbauhülse

**34,00 €**

Configura

Configure / Konfigurieren

[www.teamitaliailluminazione.it](http://www.teamitaliailluminazione.it)



C 4000K



**CODICE COMPLETO DEL PRODOTTO NELLA FOTO**  
FULL PRODUCT CODE AS SHOWN IN PICTURE  
VOLLSTÄNDIGER CODE VOM ARTIKEL IM BILD

**4017TF OV E28 B + 9017F**

Codice  
Code

Finitura  
Finishing  
Lackierung

Diffusore  
Diffuser  
Diffusor

Tonalità  
Hue  
Farbton

Codice  
Code

INDEX

SECTION

FAMILY 311





# S-POT

INCASSO  
RECESSED LIGHT  
EINBAULEUCHE



configurazione standard: / basic configuration: / Standard Konfiguration:

24° Ottica - Optic - Optik ● B 3000K

BV

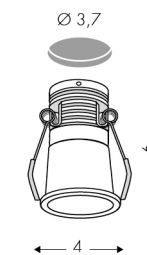

**4017TBV24B** Max 4W 480lm\* - 300mA 10V **50,00 €**

Alimentatore - Power supply - Netzteil

**AE008F** PHASE CUT (Dimmer) 20W 300mA / 1-4 art. 4017T **44,00 €**

**AE007A** DALI (Push) 30W 300mA / 1-5 art. 4017T **65,00 €**

[Configura](#) Configure / Konfigurieren

[www.teamitaliailluminazione.it](http://www.teamitaliailluminazione.it)

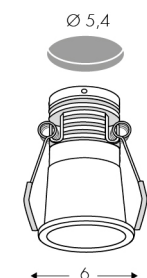

**4017UBV24B** Max 9W 860lm - 300mA 30V **54,00 €**

Alimentatore - Power supply - Netzteil

**AE008G** PHASE CUT (Dimmer) 20W 300mA/max 1 art. 4017U **25,00 €**

**AE007C** DALI (Push) - 20W 300mA/max 1 art. 4017U **55,00 €**

[Configura](#) Configure / Konfigurieren

[www.teamitaliailluminazione.it](http://www.teamitaliailluminazione.it)

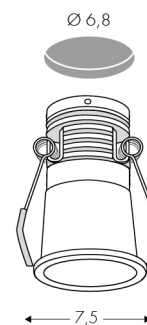

**4017VBV24B** Max 13,5W 1290lm - 300mA 45V **67,00 €**

Alimentatore - Power supply - Netzteil

**AE008H** PHASE CUT (Dimmer) - 20W 300mA/max 1 art. 4017V **46,00 €**

**AE007F** DALI (Push) - 20W 300mA/max 1 art. 4017V **56,00 €**

[Configura](#) Configure / Konfigurieren

[www.teamitaliailluminazione.it](http://www.teamitaliailluminazione.it)



NE RV BR OV



Alimentatore non incluso - Power Supply not included - Netzteil nicht inbegriffen

\* 480lm effettivi - effective - effektive con - with - mit 24°

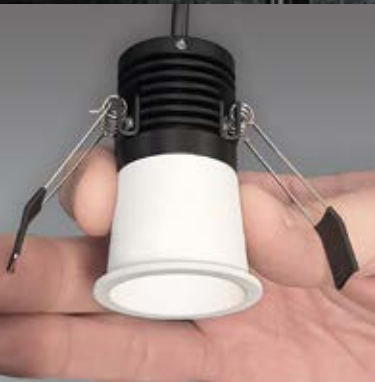

**CODICE COMPLETO DEL PRODOTTO NELLA FOTO**  
FULL PRODUCT CODE AS SHOWN IN PICTURE - VOLLSTÄNDIGER CODE VOM ARTIKEL IM BILD

**4017V**

Codice  
Code

**BV**

Finitura  
Finishing  
Lackierung

**24**

Diffusore  
Diffuser  
Diffusor

**B**

Tonalità  
Hue  
Farbton



configurazione standard: / basic configuration: / Standard Konfiguration:

GU10

BV

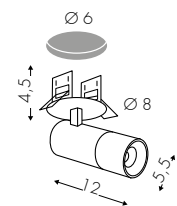

**4044DBV**

GU10 max 1x7W LED - 220V

**82,00 €**

Configura Configure / Konfigurieren

[www.teamitaliailluminazione.it](http://www.teamitaliailluminazione.it)

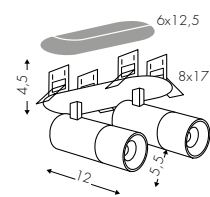

**4044EBV**

GU10 max 2x7W LED - 220V

**163,00 €**

Configura Configure / Konfigurieren

[www.teamitaliailluminazione.it](http://www.teamitaliailluminazione.it)



NE



configurazione standard: / basic configuration: / Standard Konfiguration:

24° Ottica - Optic - Optik ● B 3000K

BV

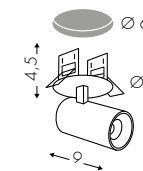

**4044PBV24B**

7W 680lm\* - 350mA 20V

**104,00 €**

Alimentatore - Power supply - Netzteil

<b>AE006A</b>	OnOff 10W 350mA / 1 art. 4044P	<b>16,00 €</b>
<b>AE006B</b>	OnOff 16W 350mA / 2 art. 4044P	<b>28,00 €</b>
<b>AE007A</b>	DALI (Push) 19,2W 350mA / 1-2 art. 4044P	<b>65,00 €</b>
<b>AE008A</b>	PHASE CUT (Dimmer) 10W 350mA / 1 art. 4044P	<b>26,00 €</b>
<b>AE008B</b>	PHASE CUT (Dimmer) 18W 350mA / 2 art. 4044P	<b>26,00 €</b>

Configura Configure / Konfigurieren

[www.teamitaliailluminazione.it](http://www.teamitaliailluminazione.it)

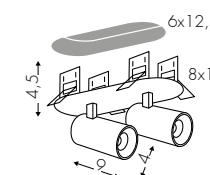

**4044QBV24B**

2x7W 2x680lm - 350mA 40V

**214,00 €**

Alimentatore - Power supply - Netzteil

<b>AE006B</b>	OnOff 16W 350mA / 1 art. 4044Q	<b>28,00 €</b>
<b>AE007A</b>	DALI (Push) 19,2W 350mA / 1 art. 4044Q	<b>65,00 €</b>
<b>AE008B</b>	PHASE CUT (Dimmer) 18W 350mA / 1 art. 4044Q	<b>26,00 €</b>

Configura Configure / Konfigurieren

[www.teamitaliailluminazione.it](http://www.teamitaliailluminazione.it)

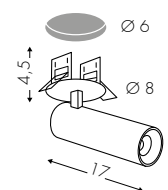

**4044UBV24B**

13W 1300lm - 350mA 36V

**119,00 €**

Alimentatore - Power supply - Netzteil

<b>AE006B</b>	OnOff 16W 350mA / 1 art. 4044U	<b>28,00 €</b>
<b>AE007A</b>	DALI (Push) 19,2W 350mA / 1 art. 4044U	<b>65,00 €</b>
<b>AE008B</b>	PHASE CUT (Dimmer) 18W 350mA / 1 art. 4044U	<b>26,00 €</b>

Configura Configure / Konfigurieren

[www.teamitaliailluminazione.it](http://www.teamitaliailluminazione.it)



○ C 4000K

NE



GU10 Sorgente non inclusa - Not included light source - Lichtquelle nicht enthalten

**CODICE COMPLETO DEL PRODOTTO NELLA FOTO**  
FULL PRODUCT CODE AS SHOWN IN PICTURE • VOLLSTÄNDIGER CODE VOM ARTIKEL IM BILD

**4044E**

Codice  
Code

**NE**

Finitura  
Finishing  
Lackierung

Alimentatore non incluso - Power Supply not included  
Netzteil nicht inbegriffen

\* 680lm effettivi - effective - effektive con - with - mit 24°

INDEX

SECTION

FAMILY



GU10



configurazione standard: / basic configuration: / Standard Konfiguration:

BV

GU10

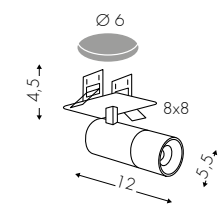

**4044ABV**

GU10 max 1x7W LED - 220V

**82,00 €**

Configura Configure / Konfigurieren

[www.teamitaliailluminazione.it](http://www.teamitaliailluminazione.it)

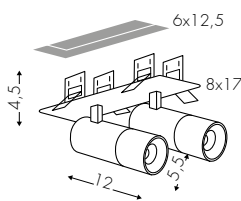

**4044BBV**

GU10 max 2x7W LED - 220V

**163,00 €**

Configura Configure / Konfigurieren

[www.teamitaliailluminazione.it](http://www.teamitaliailluminazione.it)



NE

GU10 Sorgente non inclusa - Not included light source - Lichtquelle nicht enthalten

**CODICE COMPLETO DEL PRODOTTO NELLA FOTO**  
FULL PRODUCT CODE AS SHOWN IN PICTURE • VOLLSTÄNDIGER CODE VOM ARTIKEL IM BILD

**4044B**

Codice  
Code

**NE**

Finitura  
Finishing  
Lackierung

configurazione standard: / basic configuration: / Standard Konfiguration:

BV

24° Ottica - Optic - Optik B 3000K

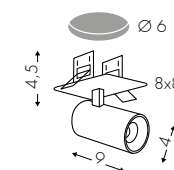

**4044MBV24B**

7W 680lm\* - 350mA 20V

**104,00 €**

Alimentatore - Power supply - Netzteil

**AE006A** OnOff 10W 350mA / 1 art. 4044M **16,00 €**

**AE006B** OnOff 16W 350mA / 2 art. 4044M **28,00 €**

**AE007A** DALI (Push) 19,2W 350mA / 1-2 art. 4044M **65,00 €**

**AE008A** PHASE CUT (Dimmer) 10W 350mA / 1 art. 4044M **26,00 €**

**AE008B** PHASE CUT (Dimmer) 18W 350mA / 2 art. 4044M **26,00 €**

Configura Configure / Konfigurieren

[www.teamitaliailluminazione.it](http://www.teamitaliailluminazione.it)

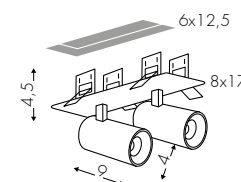

**4044NBV24B**

2x7W 2x680lm - 350mA 40V

**214,00 €**

Alimentatore - Power supply - Netzteil

**AE006B** OnOff 16W 350mA / 1 art. 4044N **28,00 €**

**AE007A** DALI (Push) 19,2W 350mA / 1 art. 4044N **65,00 €**

**AE008B** PHASE CUT (Dimmer) 18W 350mA / 1 art. 4044N **26,00 €**

Configura Configure / Konfigurieren

[www.teamitaliailluminazione.it](http://www.teamitaliailluminazione.it)

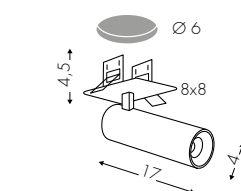

**4044RBV24B**

13W 1300lm - 350mA 36V

**119,00 €**

Alimentatore - Power supply - Netzteil

**AE006B** OnOff 16W 350mA / 1 art. 4044R **28,00 €**

**AE007A** DALI (Push) 19,2W 350mA / 1 art. 4044R **65,00 €**

**AE008B** PHASE CUT (Dimmer) 18W 350mA / 1 art. 4044R **26,00 €**

Configura Configure / Konfigurieren

[www.teamitaliailluminazione.it](http://www.teamitaliailluminazione.it)



NE

C 4000K

Alimentatore non incluso  
Power Supply not included - Netzteil nicht inbegriffen

\* 680lm effettivi - effective - effektive con - with - mit 24°

INDEX

SECTION

FAMILY







configurazione standard: / basic configuration: / Standard Konfiguration:

24° Ottica - Optic Optik ● B 3000K

BV

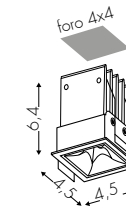

<b>4048ABV24B</b>	4W 400lm* - 150mA 30V	<b>52,00 €</b>
Alimentatore - Power supply - Netzteil		
<b>AE006E</b>	OnOff 6W 150mA / 1 art. 4048A	<b>22,00 €</b>
<b>AE008F</b>	PHASE CUT (Dimmer) 20W 150mA / 1 art. 4048A	<b>44,00 €</b>

Configura Configure / Konfigurieren [www.teamitaliailluminazione.it](http://www.teamitaliailluminazione.it)

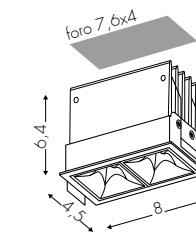

<b>4048BBV24B</b>	7,5W 900lm - 250mA - 30V	<b>83,00 €</b>
Alimentatore - Power supply - Netzteil		
<b>AE006D</b>	OnOff 9W 250mA / 1 art. 4048B	<b>22,00 €</b>
<b>AE007C</b>	DALI (Push) 10W 250mA / 1 art. 4048B	<b>55,00 €</b>
<b>AE008F</b>	PHASE CUT (Dimmer) 20W 250mA / 1 art. 4048B	<b>44,00 €</b>

Configura Configure / Konfigurieren [www.teamitaliailluminazione.it](http://www.teamitaliailluminazione.it)

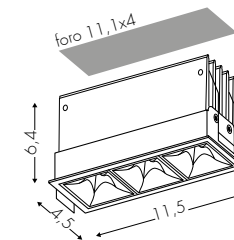

<b>4048CBV24B</b>	15W 1500lm - 500mA - 36V	<b>125,00 €</b>
Alimentatore - Power supply - Netzteil		
<b>AE006F</b>	OnOff 20W 500mA / 1 art. 4048C	<b>27,00 €</b>
<b>AE007B</b>	DALI (Push) 25W 500mA / 1 art. 4048C	<b>62,00 €</b>
<b>AE008F</b>	PHASE CUT (Dimmer) 20W 500mA / 1 art. 4048C	<b>44,00 €</b>

Configura Configure / Konfigurieren [www.teamitaliailluminazione.it](http://www.teamitaliailluminazione.it)

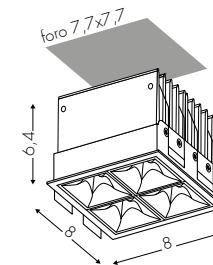

<b>4048DBV24B</b>	18W - 1800lm - 600mA - 30V	<b>163,00 €</b>
Alimentatore - Power supply - Netzteil		
<b>AE006G</b>	OnOff 24W 600mA / 1 art. 4048D	<b>35,00 €</b>
<b>AE007B</b>	DALI (Push) 25W 600mA / 1 art. 4048D	<b>62,00 €</b>
<b>AE008F</b>	PHASE CUT (Dimmer) 20W 600mA / 1 art. 4048D	<b>44,00 €</b>

Configura Configure / Konfigurieren [www.teamitaliailluminazione.it](http://www.teamitaliailluminazione.it)



Alimentatore non incluso - Power supply not included - Netzteil nicht inbegriffen

\* 400lm effettivi - effective - effektive con - with - mit 24°



**CODICE COMPLETO DEL PRODOTTO NELLA FOTO**  
FULL PRODUCT CODE AS SHOWN IN PICTURE - VOLLSTÄNDIGER CODE VOM ARTIKEL IM BILD

**4048D**

Codice  
Code

**BV**

Finitura  
Finishing  
Lackierung

**24**

Diffusore  
Diffuser  
Diffusor

**B**

Tonalità  
Hue  
Farbton





configurazione standard: / basic configuration: / Standard Konfiguration:

E8 Trasparente - Transparent ● B 3000K



**4069IOFONE8B** 3W 350lm\* - 220V

**248,00 €**

[Configura](#) Configure / Konfigurieren

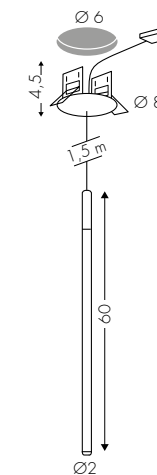

**4069UTFONE8B** 2x3W 2x350lm - 220V

**454,00 €**

**C005T2NE** Custom black cable

**8,00 € /MT**

[Configura](#) Configure / Konfigurieren

[www.teamitaliailluminazione.it](http://www.teamitaliailluminazione.it)



E19 ● A 2700K

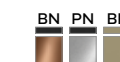

**CODICE COMPLETO DEL PRODOTTO NELLA FOTO**  
FULL PRODUCT CODE AS SHOWN IN PICTURE - VOLLSTÄNDIGER CODE VOM ARTIKEL IM BILD

**4069IOF** **PN** **E8** **B** + **C005T2NE**

Codice  
Code

Finitura  
Finishing  
Lackierung

Diffusore  
Diffuser  
Diffusor

Tonalità  
Hue  
Farbton

Codice  
Code

custom BLACK CABLE

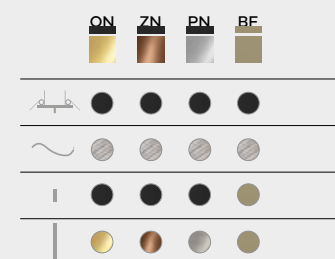

**A** ↑ Alimentatore incluso in remoto - Included Power Supply in remote - Fernspeisung enthalten  
**TF** Taglio di Fase - Phase-Cut Dimmer - Phasenabschrittdimmer

\* 350lm effettivi - effective - effektive con - with - mit E8



E8



# VENIS

INCASSO  
RECESSED LIGHT  
EINBAULEUCHE



configurazione standard: / basic configuration: / Standard Konfiguration:

E2 Opale - Opal - Opal ● B 3000K



**4064ATFNTE2B** 6,5W 800lm\* - 220V

**350,00 €**

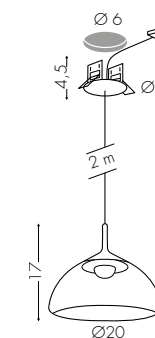

● **C005T2NE** Custom black cable

**8,00 € /MT**

Configura Configure / Konfigurieren

[www.teamitaliailluminazione.it](http://www.teamitaliailluminazione.it)



● **A 2700K**



**CODICE COMPLETO DEL PRODOTTO NELLA FOTO**  
FULL PRODUCT CODE AS SHOWN IN PICTURE - VOLLSTÄNDIGER CODE VOM ARTIKEL IM BILD

**1064ATF** **NZ** **E2** **A**

Codice Code	Finitura Finishing Lackierung	Diffusore Diffuser Diffusor	Tonalità Hue Farbton
----------------	-------------------------------------	-----------------------------------	----------------------------

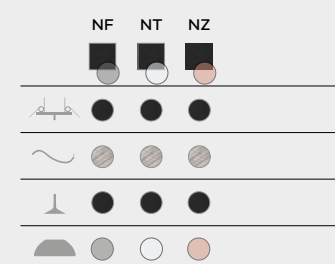

Alimentatore incluso in remoto - Included Power Supply in remote - Fernspeisung enthalten  
**TF** Taglio di Fase - Phase-Cut Dimmer - Phasenabschrittdimmer

\* 800lm effettivi - effective - effektive con - with - mit **E2**



# Profili/Profiles/Profile

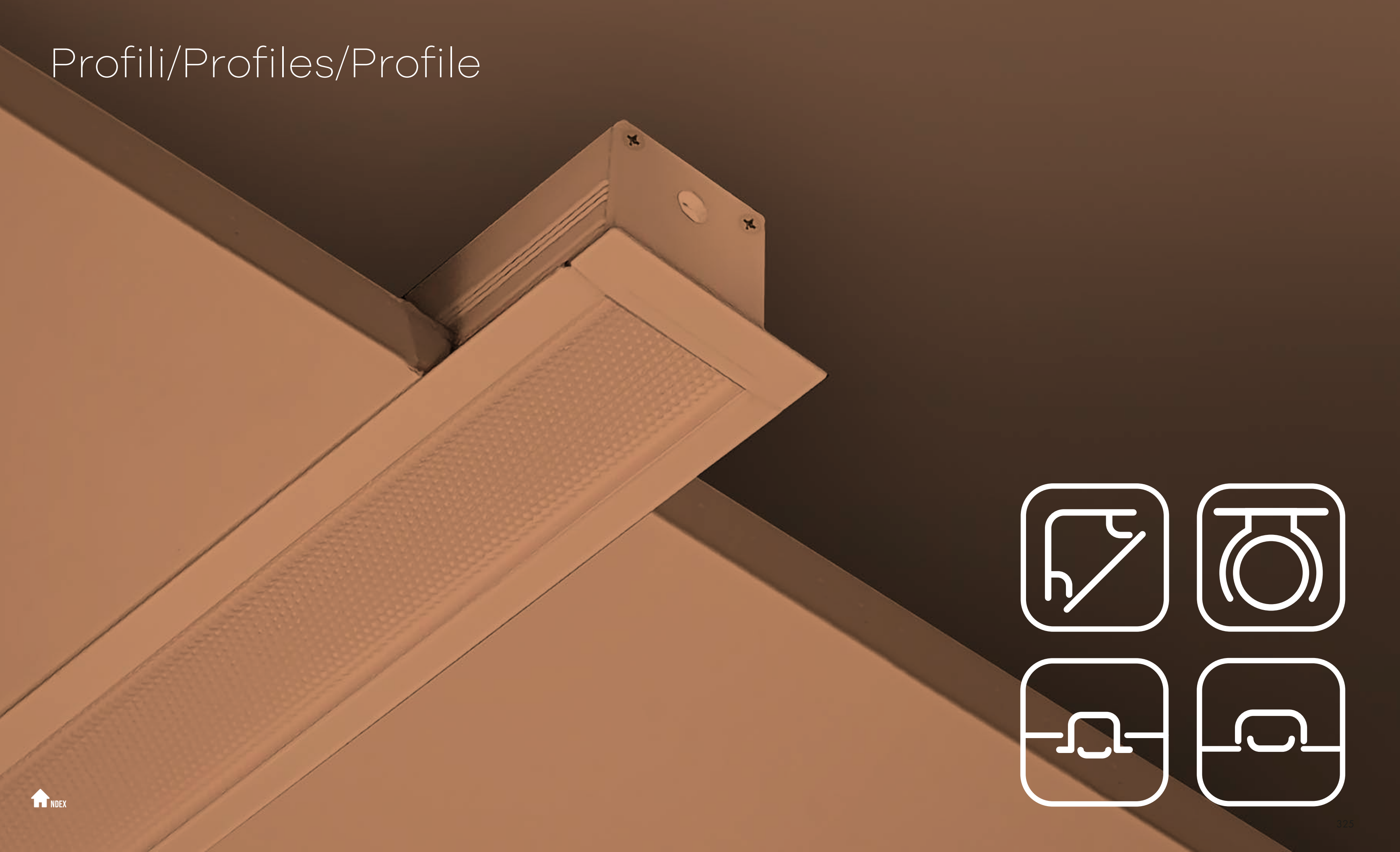

**Universali/Universal/Universal**



**Profili universali** 329  
orientabile 360° downlight [100-250cm]

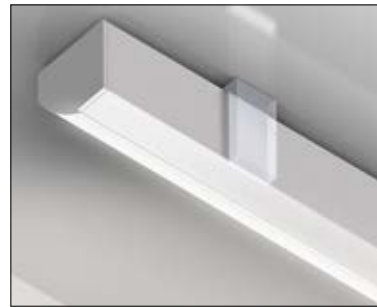

**Profili universali** 331  
angolare [100-250cm]



**Profili universali** 333  
basic [100-300cm]



**Profili universali** 335  
plafone S [100-250cm]

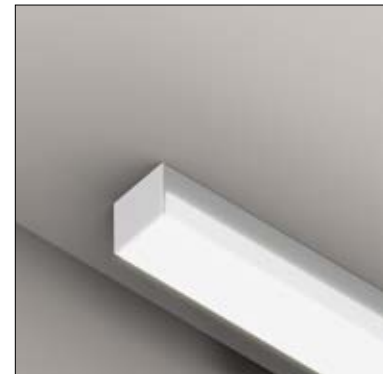

**Profili universali** 337  
profilo multiuso [100-250cm]

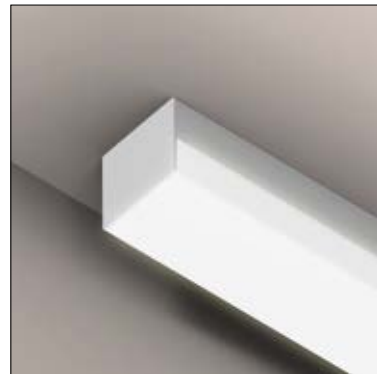

**Profili universali** 339  
profilo multiuso M [100-300cm]

**Velette luminose/Wall washing effect/Wall washer-effekt**



**Velette luminose** 341  
veletta luminosa O [100-300cm]



**Velette luminose** 343  
veletta luminosa H [100-300cm]

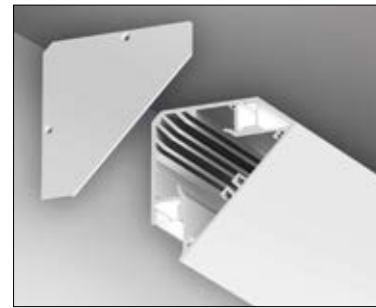

**Velette luminose** 345  
biemissione [100-300cm]

**Incasso con cornice/Recessed profile/Einbau profile**



**Incasso con cornice** 347  
incasso con cornice [100-250cm]



**Incasso con cornice** 349  
incasso con cornice C [100-250cm]



**Incasso con cornice** 351  
incasso con cornice M [100-250cm]



**Incasso con cornice** 353  
incasso con cornice L [100-250cm]

**Incasso filomuro/Recessed wall flush effect/Einbauchte bündig mit der wand**



**Incasso a raso** 355  
incasso filomuro I [100-300cm]  
Cartongesso ESCLUSO



**Incasso a raso** 357  
incasso filomuro N [100-300cm]  
Cartongesso INCLUSO

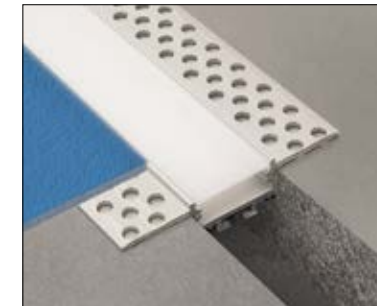

**Incasso a raso** 359  
incasso filomuro F [100-300cm]  
Cartongesso ESCLUSO

**Complementi/Complements/Ergänzungen**



**Striped** 360



**Drivers** 362

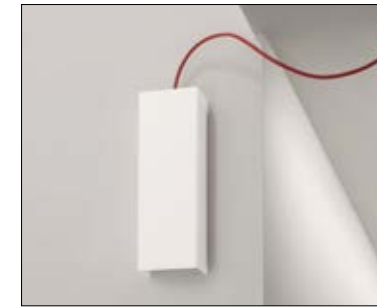

**Rosoni / Canopy** 363

**Sistemi di gestione della luce/Light system management/Lichtsteuersysteme**

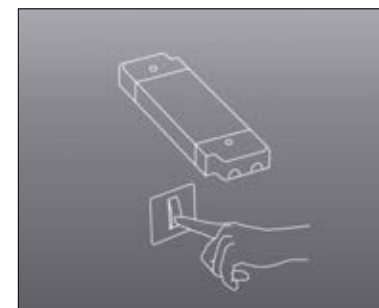

**PLC Push Light Control** 362  
Gestione della luce con pulsante Push



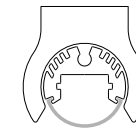

## 6010 - ORIENTABILE 360°



<b>6010Z0MT1</b>	profile 100 cm (NO LED)	<b>43,00 €</b>	<b>31,00 €</b>
<b>6010Z0MT2</b>	profile 200 cm (NO LED)	<b>86,00 €</b>	<b>61,00 €</b>
<b>6010Z0MT25</b>	profile 250 cm (NO LED)	<b>108,00 €</b>	<b>76,00 €</b>

 E2 Opale - Opal  
 E28 Satinato - Frosted - Satiniert

 Led non incluso - Led not included - Led nicht inbegriffen  
 Alimentatore non incluso - Power Supply not included - Netzteil nicht inbegriffen



Accessori inclusi  
Accessories included  
Einschließlich Zubehör

SERVIZIO SU MISURA



**001001A** Taglio Profilo - Cut service **10,00 €**

Configura  Configure / Konfigurieren

[www.teamitaliailluminazione.it](http://www.teamitaliailluminazione.it) 

CODICE COMPLETO • COMPLETE CODE • VOLLSTÄNDIGE CODE

**6010Z0MT25** **BV** **E2** + **001001A**

Codice  
Code  
Code

Finitura  
Finishing  
Lackierung

Diffusore  
Diffuser  
Diffusor

SERVICE

**STRIP E ROLLE LED** pag. 360-361  
**DRIVERS & DIMMER**  
**E ROSONI** pag. 362-363







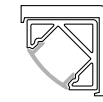

## 8010 - ANGOLARE



<b>8010ZOMT1</b>	profile 100 cm (NO LED)	<b>41,00 €</b>	<b>30,00 €</b>
<b>8010ZOMT2</b>	profile 200 cm (NO LED)	<b>82,00 €</b>	<b>59,00 €</b>
<b>8010ZOMT25</b>	profile 250 cm (NO LED)	<b>102,00 €</b>	<b>74,00 €</b>

-  E2 Opale - Opal
-  E28 Satinato - Frosted - Satiniert

-  Led non incluso - Led not included - Led nicht inbegriffen
-  Alimentatore non incluso - Power Supply not included - Netzteil nicht inbegriffen



Accessori inclusi  
Accessories included  
Einschließlich Zubehör

## SERVIZIO SU MISURA



**001001A** Taglio Profilo - Cut service **10,00 €**

[Configura](#)  [Configure / Konfigurieren](#)

[www.teamitaliailluminazione.it](http://www.teamitaliailluminazione.it) 

CODICE COMPLETO • COMPLETE CODE • VOLLSTÄNDIGE CODE

**8010ZOMT25** **BV** **E2** + **001001A**

Code	Finitura	Diffusore	SERVICE
Code	Finishing	Diffuser	
Code	Lackierung	Diffusor	

**STRIP E ROLLE LED** pag. 360-361  
**DRIVERS & DIMMER**  
**E ROSONI** pag. 362-363





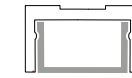

## 3010F - BASIC



<b>3010FZ0MT1</b>	profile 100 cm (NO LED)	<b>34,00 €</b>	<b>25,00 €</b>
<b>3010FZ0MT2</b>	profile 200 cm (NO LED)	<b>68,00 €</b>	<b>49,00 €</b>
<b>3010FZ0MT3</b>	profile 300 cm (NO LED)	<b>102,00 €</b>	<b>74,00 €</b>

-  E2 Opale - Opal
-  E28 Satinato - Frosted - Satiniert

-  Led non incluso - Led not included - Led nicht inbegriffen
-  Alimentatore non incluso - Power Supply not included - Netzteil nicht inbegriffen

<b>3010FTP</b>	KIT TAPPI PROFILO 3010 F	<b>8,00 €</b>
<b>AE002A</b>	SENSORE TOUCH ON/OFF	<b>52,00 €</b>

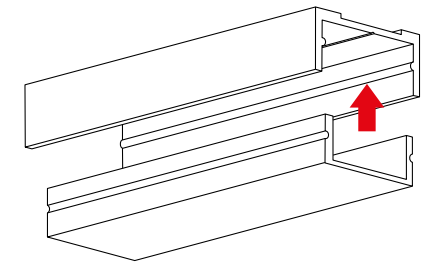
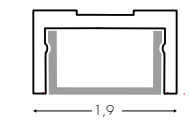

## SERVIZIO SU MISURA

<b>001001A</b>	Taglio Profilo - Cut service	<b>10,00 €</b>
----------------	------------------------------	----------------



Configura  Configure / Konfigurieren

[www.teamitaliailluminazione.it](http://www.teamitaliailluminazione.it) 

CODICE COMPLETO • COMPLETE CODE • VOLLSTÄNDIGE CODE

**3010FZ0MT2** **BV** **E2** + **001001A**

Code	Finitura	Diffusore	SERVICE
Code	Finishing	Diffuser	
Code	Lackierung	Diffusor	

**STRIP E ROLLE LED** pag. 360-361  
**DRIVERS & DIMMER**  
**E ROSONI** pag. 362-363







# PROFILI

## 3010E - PLAFONE S

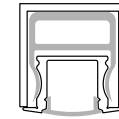

<b>3010EZ0MT1</b>	profile 100 cm (NO LED)	<b>63,00 €</b>	<b>72,00 €</b>
<b>3010EZ0MT2</b>	profile 200 cm (NO LED)	<b>125,00 €</b>	<b>144,00 €</b>
<b>3010EZ0MT25</b>	profile 250 cm (NO LED)	<b>156,00 €</b>	<b>180,00 €</b>

- E2 Opale - Opal
- E28 Satinato - Frosted - Satiniert

- Led non incluso - Led not included - Led nicht inbegriffen
- Alimentatore non incluso - Power Supply not included - Netzteil nicht inbegriffen

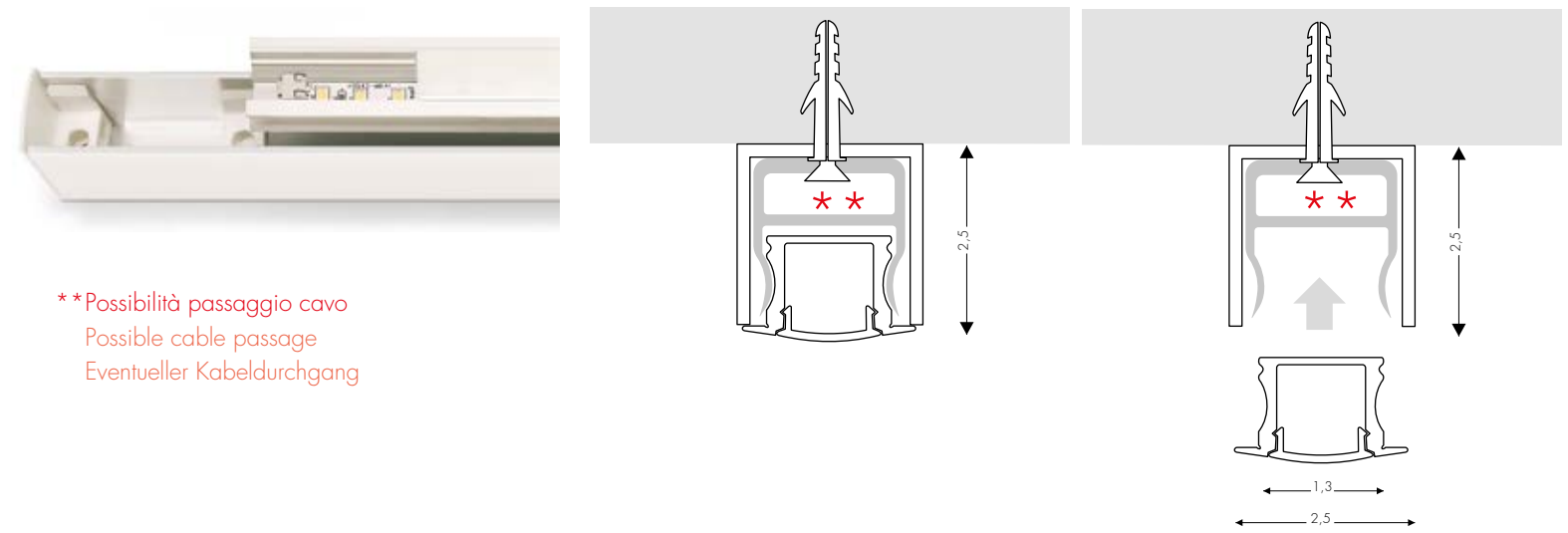

\*\*Possibilità passaggio cavo  
Possible cable passage  
Eventueller Kabeldurchgang

SERVIZIO SU MISURA



001001A

Taglio Profilo - Cut service

**10,00 €**

Configura Configure / Konfigurieren

[www.teamitaliailluminazione.it](http://www.teamitaliailluminazione.it)

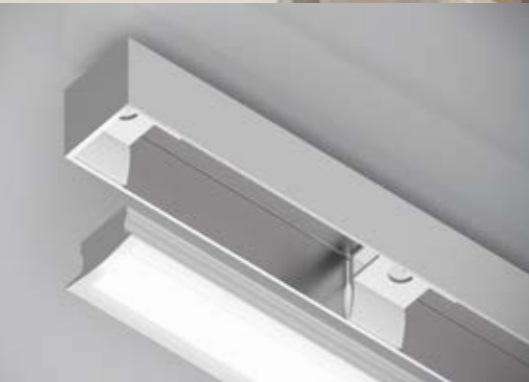

**STRIP E ROLLE LED** pag. 360-361  
**DRIVERS & DIMMER**  
**E ROSONI** pag. 362-363





## 3010 - PROFILO MULTIUSO

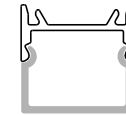

<b>3010ZOMT1</b>	profile 100 cm (NO LED)	<b>46,00 €</b>	<b>31,00 €</b>
<b>3010ZOMT2</b>	profile 200 cm (NO LED)	<b>92,00 €</b>	<b>61,00 €</b>
<b>3010ZOMT25</b>	profile 250 cm (NO LED)	<b>115,00 €</b>	<b>76,00 €</b>

 **E2 Opale - Opal**

 Led non incluso - Led not included - Led nicht inbegriffen

 Alimentatore non incluso - Power Supply not included - Netzteil nicht inbegriffen



Accessori inclusi  
Accessories included  
Einschließlich Zubehör

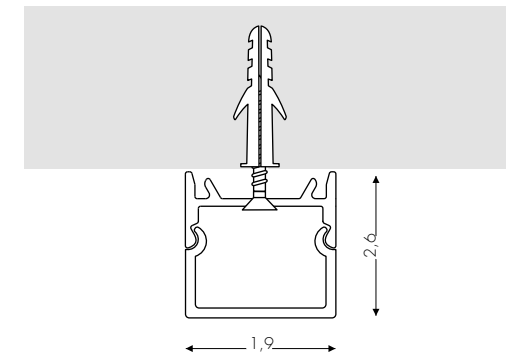

SERVIZIO SU MISURA



**001001A**

Taglio Profilo - Cut service

**10,00 €**

[Configura](#)  Configure / Konfigurieren

[www.teamitaliailluminazione.it](http://www.teamitaliailluminazione.it) 

CODICE COMPLETO • COMPLETE CODE • VOLLSTÄNDIGE CODE

**3010ZOMT25** **BV** **E2** + **001001A**

Code	Finitura	Diffusore	SERVICE
Code	Finishing	Diffuser	
Code	Lackierung	Diffusor	

**STRIP E ROLLE LED** pag. 360-361  
**DRIVERS & DIMMER**  
**E ROSONI** pag. 362-363

 INDEX

 SECTION

 FAMILY 337

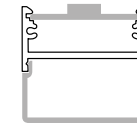

## 3010M - PROFILO MULTIUSO

BV



<b>3010MZOMT1</b>	profile 100 cm (NO LED)	<b>48,00 €</b>
<b>3010MZOMT2</b>	profile 200 cm (NO LED)	<b>96,00 €</b>
<b>3010MZOMT3</b>	profile 300 cm (NO LED)	<b>144,00 €</b>

 E2 Opale - Opal

 Led non incluso - Led not included - Led nicht inbegriffen  
 Alimentatore non incluso - Power Supply not included - Netzteil nicht inbegriffen



2 testate incluse  
2 end caps included  
2 Endkappen enthalten

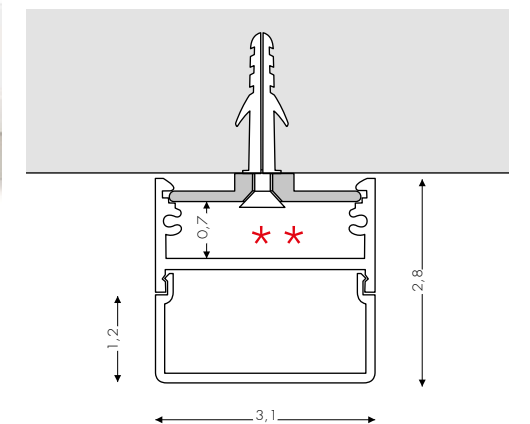

\*\* Possibilità passaggio cavo  
Possible cable passage  
Eventueller Kabeldurchgang

SERVIZIO SU MISURA

001001A

Taglio Profilo - Cut service

**10,00 €**



Configura  Configure / Konfigurieren

[www.teamitaliailluminazione.it](http://www.teamitaliailluminazione.it) 

CODICE COMPLETO • COMPLETE CODE • VOLLSTÄNDIGE CODE

**3010MZOMT2** **BV** **E2** + **001001A**

Codice  
Code  
Code

Finitura  
Finishing  
Lackierung

Diffusore  
Diffuser  
Diffusor

SERVICE

**STRIP E ROLLE LED** pag. 360-361  
**DRIVERS & DIMMER**  
**E ROSONI** pag. 362-363

 INDEX

 SECTION

 FAMILY 339



## 40100 - VELETTA LUMINOSA

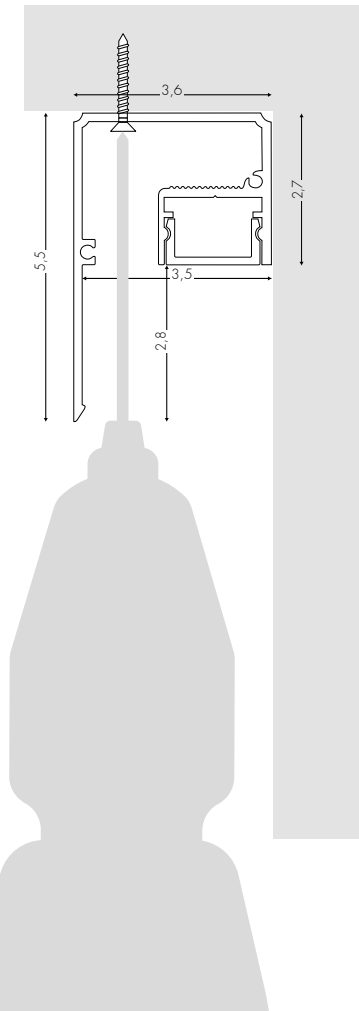

<b>40100Z0MT1</b>	profile 100 cm (NO LED)	<b>52,00 €</b>	<b>58,00 €</b>
<b>40100Z0MT2</b>	profile 200 cm (NO LED)	<b>104,00 €</b>	<b>116,00 €</b>
<b>40100Z0MT3</b>	profile 300 cm (NO LED)	<b>156,00 €</b>	<b>174,00 €</b>

■ E2 Opale - Opal  
● L30 Lente 30° - Lens 30° - Linse 30°

✗ Led non incluso - Led not included - Led nicht inbegriffen  
✗ Alimentatore non incluso - Power Supply not included - Netzteil nicht inbegriffen

**40100GL** confezione di giunti meccanici da 5 pz. **48,00 €**

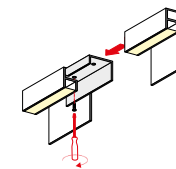

2 testate incluse  
2 end caps included  
2 Endkappen enthalten



SERVIZIO SU MISURA



**001001A** Taglio Profilo - Cut service **10,00 €**

Configura Configura / Konfigurieren

[www.teamitaliailluminazione.it](http://www.teamitaliailluminazione.it)

CODICE COMPLETO • COMPLETE CODE • VOLLSTÄNDIGE CODE

**40100Z0MT3** **BV** **E2** + **001001A**

Codice  
Code  
Code

Finitura  
Finishing  
Lackierung

Diffusore  
Diffuser  
Diffusor

SERVICE

**STRIP E ROLLE LED** pag. 360-361  
**DRIVERS & DIMMER**  
**E ROSONI** pag. 362-363







## 4010H - VELETTA LUMINOSA

RASOMURO

BV

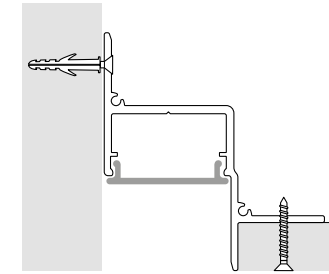

<b>4010HZ0MT1</b>	profile 100 cm (NO LED)	<b>48,00 €</b>
<b>4010HZ0MT2</b>	profile 200 cm (NO LED)	<b>96,00 €</b>
<b>4010HZ0MT3</b>	profile 300 cm (NO LED)	<b>144,00 €</b>

E2 Opale - Opal

Led non incluso - Led not included - Led nicht inbegriffen

Alimentatore non incluso - Power Supply not included - Netzteil nicht inbegriffen



## 4010HTS

coppia di testate - kit of end-caps - Endkappe

**11,00 €** A COPPIA

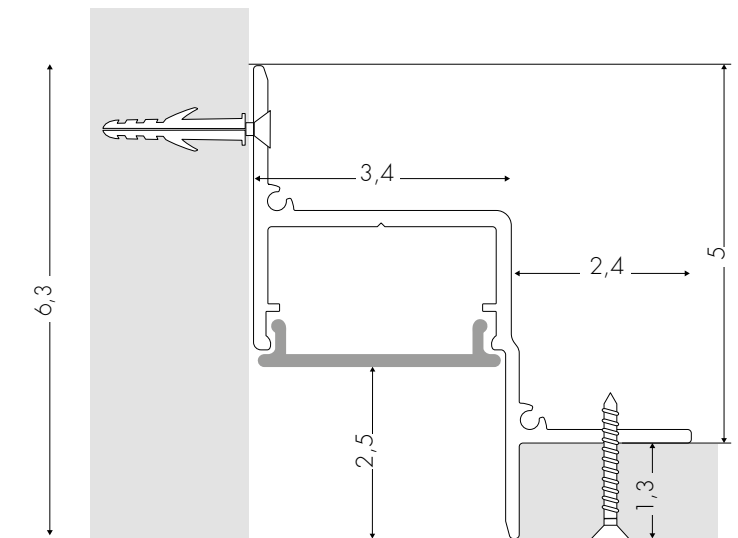

## SERVIZIO SU MISURA



## 001001A

Taglio Profilo - Cut service

**10,00 €**

Configura

Configure / Konfigurieren

[www.teamitaliailluminazione.it](http://www.teamitaliailluminazione.it)

CODICE COMPLETO • COMPLETE CODE • VOLLSTÄNDIGE CODE

**4010HZ0MT3** **BV** **E2** + **001001A**

Codice  
Code  
Code

Finitura  
Finishing  
Lackierung

Diffusore  
Diffuser  
Diffusor

SERVICE

**STRIP E ROLLE LED** pag. 360-361  
**DRIVERS & DIMMER**  
**E ROSONI** pag. 362-363

INDEX

SECTION

FAMILY 343



## 8010D - BIEMISSIONE

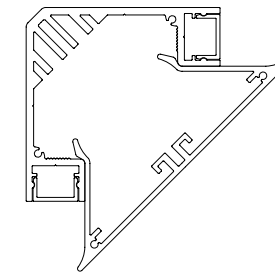

<b>8010DZ0MT1</b>	profile 100 cm (NO LED)	<b>94,00 €</b>	<b>100,00 €</b>
<b>8010DZ0MT2</b>	profile 200 cm (NO LED)	<b>188,00 €</b>	<b>200,00 €</b>
<b>8010DZ0MT3</b>	profile 300 cm (NO LED)	<b>280,00 €</b>	<b>298,00 €</b>

E2 Opale - Opal

Led non incluso - Led not included - Led nicht inbegriffen

Alimentatore non incluso - Power Supply not included - Netzteil nicht inbegriffen



**8010DTS** coppia di testate - kit of end-caps - Endkappe **20,00 €** A COPPIA

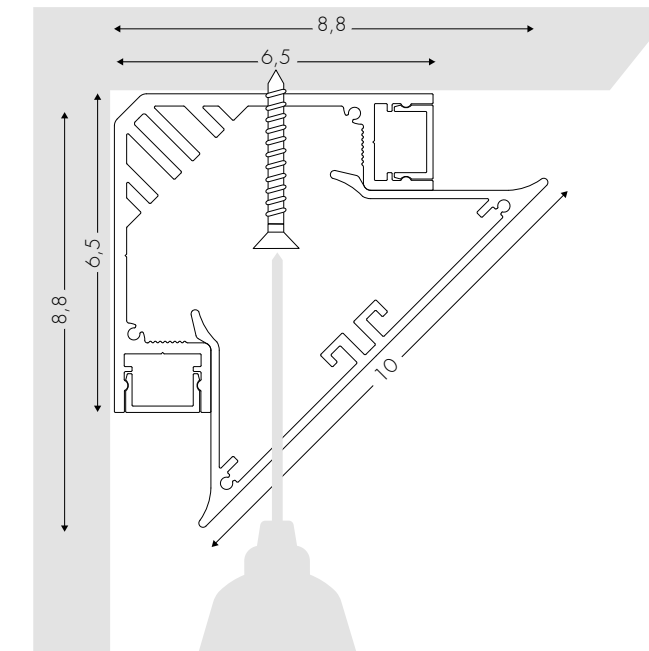

SERVIZIO SU MISURA



**001001A** Taglio Profilo - Cut service **10,00 €**

Configura Configure / Konfigurieren

[www.teamitaliailluminazione.it](http://www.teamitaliailluminazione.it)

CODICE COMPLETO • COMPLETE CODE • VOLLSTÄNDIGE CODE

**8010DZ0MT3** **BV** **E2** + **001001A**

Codice  
Code  
Code

Finitura  
Finishing  
Lackierung

Diffusore  
Diffuser  
Diffusor

SERVICE

**STRIP E ROLLE LED** pag. 360-361  
**DRIVERS & DIMMER**  
**E ROSONI** pag. 362-363





## 4010 - INCASSO BASIC CON CORNICE

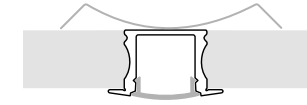

<b>4010ZOMT1</b>	profile 100 cm (NO LED)	<b>41,00 €</b>	<b>30,00 €</b>
<b>4010ZOMT2</b>	profile 200 cm (NO LED)	<b>82,00 €</b>	<b>59,00 €</b>
<b>4010ZOMT25</b>	profile 250 cm (NO LED)	<b>102,00 €</b>	<b>74,00 €</b>

- E2 Opale - Opal
- E28 Satinato - Frosted - Satiniert

- Led non incluso - Led not included - Led nicht inbegriffen
- Alimentatore non incluso - Power Supply not included - Netzteil nicht inbegriffen



2 testate incluse  
2 end caps included  
2 Endkappen enthalten

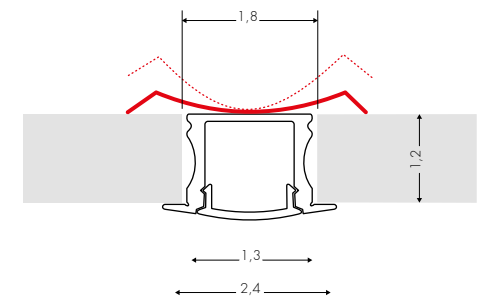

SERVIZIO SU MISURA



001001A

Taglio Profilo - Cut service

**10,00 €**

Configura Configure / Konfigurieren

[www.teamitaliailluminazione.it](http://www.teamitaliailluminazione.it)

CODICE COMPLETO • COMPLETE CODE • VOLLSTÄNDIGE CODE

**4010ZOMT25** **BV** **E2** + **001001A**

Codice  
Code  
Code

Finitura  
Finishing  
Lackierung

Diffusore  
Diffuser  
Diffusor

SERVICE

**STRIP E ROLLE LED** pag. 360-361  
**DRIVERS & DIMMER**  
**E ROSONI** pag. 362-363







# PROFILI

INCASSO CON CORNICE  
RECESSED PROFILE  
EINBAU PROFILE



4010C - INCASSO  
CON CORNICE

MURATURA

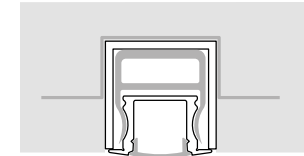

4010CZ0MT1	profile 100 cm (NO LED)	67,00 €	53,00 €
4010CZ0MT2	profile 200 cm (NO LED)	134,00 €	106,00 €
4010CZ0MT25	profile 250 cm (NO LED)	168,00 €	132,00 €

- E2 Opale - Opal
- E28 Satinato - Frosted - Satiniert

- Led non incluso - Led not included - Led nicht inbegriffen
- Alimentatore non incluso - Power Supply not included - Netzteil nicht inbegriffen

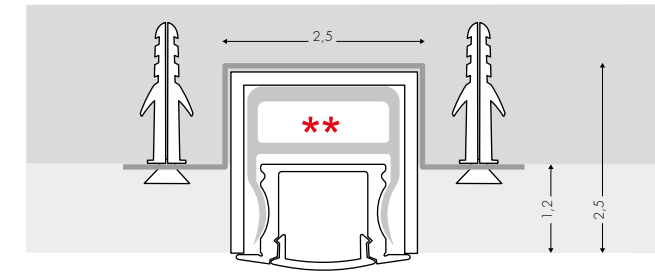

\*\*Possibilità passaggio cavo  
Passage for electrical cables  
Durchgang für elektrische Kabel

SERVIZIO SU MISURA

001001A

Taglio Profilo - Cut service

10,00 €



Configura Configure / Konfigurieren

[www.teamitaliailluminazione.it](http://www.teamitaliailluminazione.it)

CODICE COMPLETO • COMPLETE CODE • VOLLSTÄNDIGE CODE

**4010CZ0MT25** **BV** **E2** + **001001A**

Codice  
Code  
Code

Finitura  
Finishing  
Lackierung

Diffusore  
Diffuser  
Diffusor

SERVICE

STRIP E ROLLE LED pag. 360-361  
DRIVERS & DIMMER  
E ROSONI pag. 362-363





## 4010M - INCASSO CON CORNICE

BV  
□

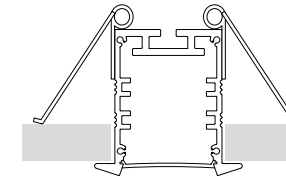

<b>4010MZ0MT1</b>	profile 100 cm (NO LED)	<b>130,00 €</b>
<b>4010MZ0MT2</b>	profile 200 cm (NO LED)	<b>260,00 €</b>
<b>4010MZ0MT25</b>	profile 250 cm (NO LED)	<b>325,00 €</b>

- E2 Opale - Opal
- E19 Prismatico - Prismatic - Prismatisch

- ✗ Led non incluso - Led not included - Led nicht inbegriffen
- ✗ Alimentatore non incluso - Power Supply not included - Netzteil nicht inbegriffen

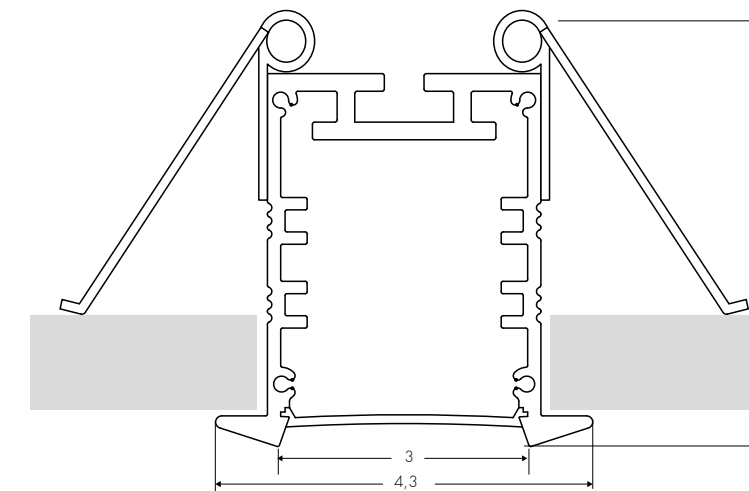

2 testate incluse  
2 end caps included  
2 Endkappen enthalten

SERVIZIO SU MISURA

001001A

Taglio Profilo - Cut service

**10,00 €**



Configura Configura / Konfigurieren

[www.teamitaliailluminazione.it](http://www.teamitaliailluminazione.it)

CODICE COMPLETO • COMPLETE CODE • VOLLSTÄNDIGE CODE

**4010MZ0MT25** **BV** **E2** + **001001A**

Codice  
Code  
Code

Finitura  
Finishing  
Lackierung

Diffusore  
Diffuser  
Diffusor

SERVICE

**STRIP E ROLLE LED** pag. 360-361  
**DRIVERS & DIMMER**  
**E ROSONI** pag. 362-363

INDEX

SECTION

FAMILY 351



# PROFILI

INCASSO CON CORNICE  
RECESSED PROFILE  
EINBAU PROFILE



## 4010L - INCASSO CON CORNICE

BV  
□

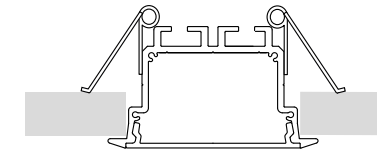

<b>4010LZ0MT1</b>	profile 100 cm (NO LED)	<b>139,00 €</b>
<b>4010LZ0MT2</b>	profile 200 cm (NO LED)	<b>278,00 €</b>
<b>4010LZ0MT25</b>	profile 250 cm (NO LED)	<b>348,00 €</b>

- E2 Opale - Opal
- E19 Prismatico - Prismatic - Prismatisch
- ✗ Led non incluso - Led not included - Led nicht inbegriffen
- ✗ Alimentatore non incluso - Power Supply not included - Netzteil nicht inbegriffen

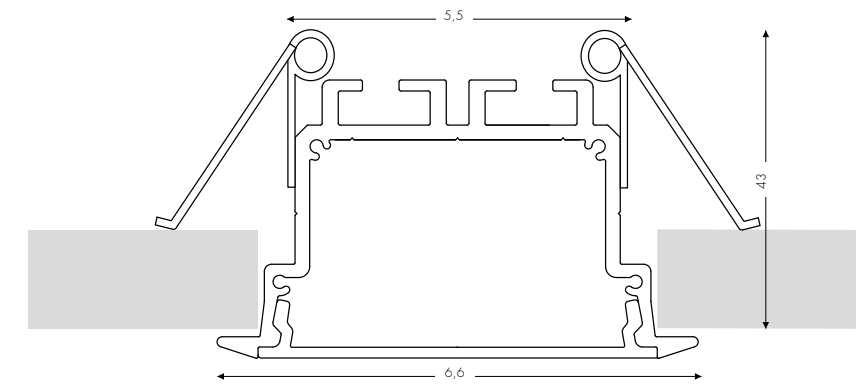

2 testate incluse  
2 end caps included  
2 Endkappen enthalten

SERVIZIO SU MISURA

001001A

Taglio Profilo - Cut service

10,00 €



Configura Configure / Konfigurieren

[www.teamitaliailluminazione.it](http://www.teamitaliailluminazione.it)

CODICE COMPLETO • COMPLETE CODE • VOLLSTÄNDIGE CODE

**4010LZ0MT25** **BV** **E2** + **001001A**

Code	Finitura	Diffusore	SERVICE
Code	Finishing	Diffuser	
Code	Lackierung	Diffusor	

**STRIP E ROLLE LED** pag. 360-361  
**DRIVERS & DIMMER**  
**E ROSONI** pag. 362-363

INDEX

SECTION

FAMILY 353





## 4010I - INCASSO A RASO

CARTONGESSO  
ESCLUSO

BV

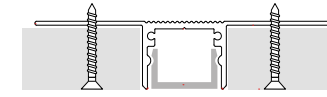

<b>4010IZOMT1</b>	profile 100 cm (NO LED)	<b>40,00 €</b>
<b>4010IZOMT2</b>	profile 200 cm (NO LED)	<b>80,00 €</b>
<b>4010IZOMT3</b>	profile 300 cm (NO LED)	<b>120,00 €</b>

E2 Opale - Opal

Led non incluso - Led not included - Led nicht inbegriffen

Alimentatore non incluso - Power Supply not included - Netzteil nicht inbegriffen

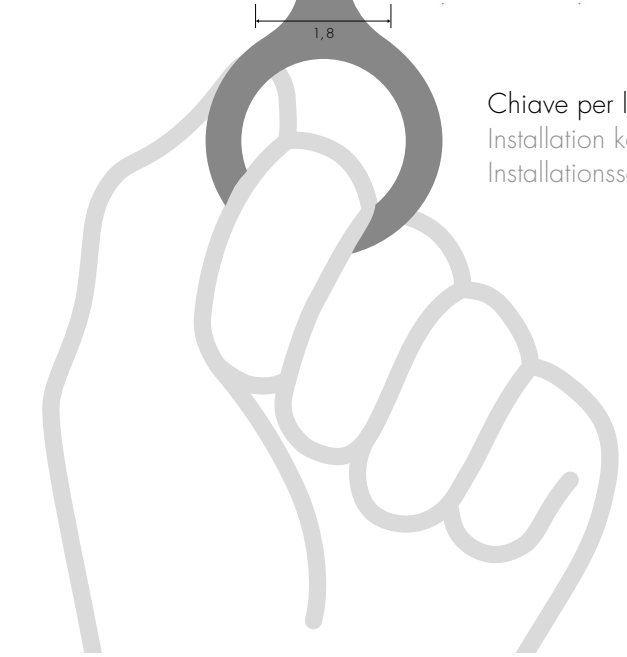
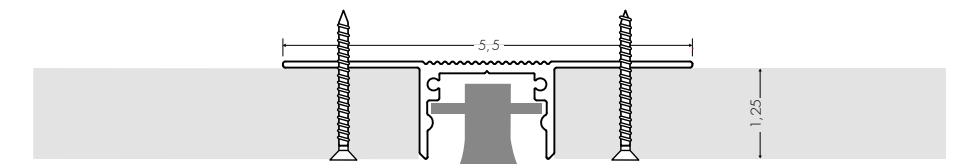

Chiave per l'installazione  
Installation key  
Installationschlüssel

SERVIZIO SU MISURA



**001001A** Taglio Profilo - Cut service **10,00 €**

Configura Configure / Konfigurieren

[www.teamitaliailluminazione.it](http://www.teamitaliailluminazione.it)

CODICE COMPLETO • COMPLETE CODE • VOLLSTÄNDIGE CODE

**4010IZOMT2** **BV** **E2** + **001001A**

Codice  
Code  
Code

Finitura  
Finishing  
Lackierung

Diffusore  
Diffuser  
Diffusor

SERVICE

**STRIP E ROLLE LED** pag. 360-361  
**DRIVERS & DIMMER**  
**E ROSONI** pag. 362-363

INDEX

SECTION

FAMILY 355



## 4010N - INCASSO A RASO

CARTONGESSO  
INCLUSO

BV

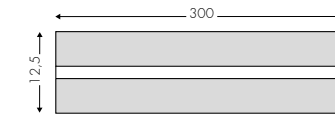

**4010NZ0MT1**  
**4010NZ0MT2**  
**4010NZ0MT3**

profile 100 cm (NO LED)  
profile 200 cm (NO LED)  
profile 300 cm (NO LED)

**52,00 €**  
**104,00 €**  
**156,00 €**

E2 Opale - Opal

Led non incluso - Led not included - Led nicht inbegriffen

Alimentatore non incluso - Power Supply not included - Netzteil nicht inbegriffen

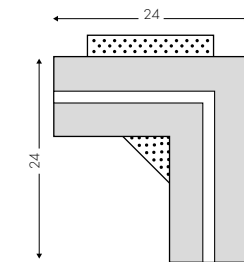

**4010NAZO**

24x24 cm. (NO LED)

**84,00 €**

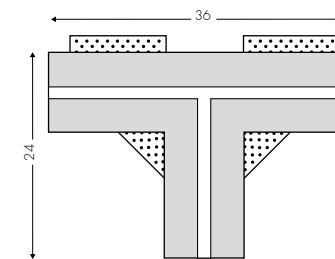

**4010NTZO**

36x24 cm. (NO LED)

**104,00 €**

SERVIZIO SU MISURA

**001001A**

Taglio Profilo - Cut service

**10,00 €**



Configura

Configure / Konfigurieren

[www.teamitaliailluminazione.it](http://www.teamitaliailluminazione.it)

CODICE COMPLETO • COMPLETE CODE • VOLLSTÄNDIGE CODE

**4010NZ0MT3** **BV** **E2** + **001001A**

Codice  
Code  
Code

Finitura  
Finishing  
Lackierung

Diffusore  
Diffuser  
Diffusor

SERVICE

**STRIP E ROLLE LED** pag. 360-361  
**DRIVERS & DIMMER**  
**E ROSONI** pag. 362-363

INDEX

SECTION

FAMILY 357



4010F - INCASSO A RASO

MURATURA

BV

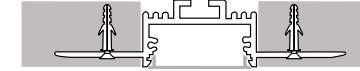

**4010FZ0MT1**  
**4010FZ0MT2**  
**4010FZ0MT3**

profile 100 cm (NO LED)  
profile 200 cm (NO LED)  
profile 300 cm (NO LED)

**46,00 €**  
**92,00 €**  
**138,00 €**

E2 Opale - Opal

Led non incluso - Led not included - Led nicht inbegriffen

Alimentatore non incluso - Power Supply not included - Netzteil nicht inbegriffen

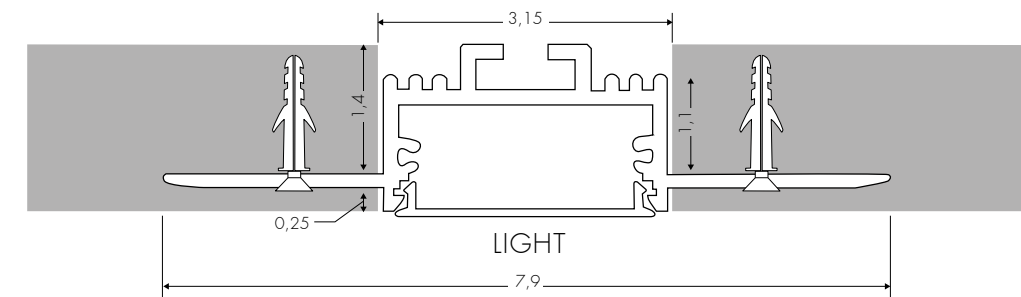

2 testate incluse  
2 end caps included  
2 Endkappen enthalten

SERVIZIO SU MISURA

001001A

Taglio Profilo - Cut service

**10,00 €**



Configura

Configure / Konfigurieren

[www.teamitaliailluminazione.it](http://www.teamitaliailluminazione.it)

CODICE COMPLETO • COMPLETE CODE • VOLLSTÄNDIGE CODE

**4010FZ0MT2** **BV** **E2** + **001001A**

Code  
Code  
Code

Finitura  
Finishing  
Lackierung

Diffusore  
Diffuser  
Diffusor

SERVICE

**STRIP E ROLLE LED** pag. 360-361  
**DRIVERS & DIMMER**  
**E ROSONI** pag. 362-363

INDEX

SECTION

FAMILY 359



## STRIPLED IP20

14.4W/mt



●	90101427K20MT	14,4W 1900lm/mt - 24VDC 2700K IP20 (1 mt)	13,00 € /mt
●	90101430K20MT	14,4W 1900lm/mt - 24VDC 3000K IP20 (1 mt)	13,00 € /mt
○	90101440K20MT	14,4W 1900lm/mt - 24VDC 4000K IP20 (1 mt)	13,00 € /mt
●	901014RGB20MT	14,4W 600lm/mt - 24VDC RGB IP20 (1 mt)	14,00 € /mt

Configura Configura / Konfigurieren [www.teamitaliailluminazione.it](http://www.teamitaliailluminazione.it)

22W/mt



●	90102227K20MT	22W 2880lm/mt - 24VDC 2700K IP20 (1 mt)	32,00 € /mt
●	90102230K20MT	22W 2880lm/mt - 24VDC 3000K IP20 (1 mt)	32,00 € /mt
○	90102240K20MT	22W 2880lm/mt - 24VDC 4000K IP20 (1 mt)	32,00 € /mt

Configura Configura / Konfigurieren [www.teamitaliailluminazione.it](http://www.teamitaliailluminazione.it)

## STRIPLED IP65

14.4W/mt



●	90101427K65MT	14,4W 1900lm/mt - 24VDC 2700K IP65 (1 mt)	15,00 € /mt
●	90101430K65MT	14,4W 1900lm/mt - 24VDC 3000K IP65 (1 mt)	15,00 € /mt
○	90101440K65MT	14,4W 1900lm/mt - 24VDC 4000K IP65 (1 mt)	15,00 € /mt
●	901014RGB65MT	14,4W 600lm/mt - 24VDC RGB IP65 (1 mt)	16,00 € /mt

Configura Configura / Konfigurieren [www.teamitaliailluminazione.it](http://www.teamitaliailluminazione.it)

22W/mt



●	90102227K65MT	22W 2880lm/mt - 24VDC 2700K IP65 (1 mt)	37,00 € /mt
●	90102230K65MT	22W 2880lm/mt - 24VDC 3000K IP65 (1 mt)	37,00 € /mt
○	90102240K65MT	22W 2880lm/mt - 24VDC 4000K IP65 (1 mt)	37,00 € /mt

Configura Configura / Konfigurieren [www.teamitaliailluminazione.it](http://www.teamitaliailluminazione.it)

\*SERVIZIO SU MISURA (S.M.)



001002A Taglio strip e saldatura - Cut service and soldering 12,00 €

## ROLLE 5MT IP20

14.4W/mt



●	90101442700	14,4W 1900lm/mt - 24VDC 2700K IP20 (5mt)	60,00 €
●	90101443000	14,4W 1900lm/mt - 24VDC 3000K IP20 (5mt)	60,00 €
○	90101444000	14,4W 1900lm/mt - 24VDC 4000K IP20 (5mt)	60,00 €
●	9010144RGB	14,4W 600lm/mt - 24VDC RGB IP20 (5mt)	66,00 €

Configura Configura / Konfigurieren [www.teamitaliailluminazione.it](http://www.teamitaliailluminazione.it)

22W/mt



●	9010222700	22W 2880lm/mt - 24VDC 2700K IP20 (5mt)	152,00 €
●	9010223000	22W 2880lm/mt - 24VDC 3000K IP20 (5mt)	152,00 €
○	9010224000	22W 2880lm/mt - 24VDC 4000K IP20 (5mt)	152,00 €

Configura Configura / Konfigurieren [www.teamitaliailluminazione.it](http://www.teamitaliailluminazione.it)

## ROLLE 5MT IP65

14.4W/mt



●	90101442700IP65	14,4W 1900lm/mt - 24VDC 2700K IP65 (5mt)	72,00 €
●	90101443000IP65	14,4W 1900lm/mt - 24VDC 3000K IP65 (5mt)	72,00 €
○	90101444000IP65	14,4W 1900lm/mt - 24VDC 4000K IP65 (5mt)	72,00 €
●	9010144RGBIP65	14,4W 600lm/mt - 24VDC RGB IP65 (5mt)	79,00 €

Configura Configura / Konfigurieren [www.teamitaliailluminazione.it](http://www.teamitaliailluminazione.it)

22W/mt



●	9010222700IP65	22W 2880lm/mt - 24VDC 2700K IP65 (5mt)	180,00 €
●	9010223000IP65	22W 2880lm/mt - 24VDC 3000K IP65 (5mt)	180,00 €
○	9010224000IP65	22W 2880lm/mt - 24VDC 4000K IP65 (5mt)	180,00 €

Configura Configura / Konfigurieren [www.teamitaliailluminazione.it](http://www.teamitaliailluminazione.it)

CODICE COMPLETO • COMPLETE CODE • VOLLSTÄNDIGE CODE

4 X **90101427K20MT** + 1 X **001002A**  
STRIPLED SERVICE

CODICE COMPLETO • COMPLETE CODE • VOLLSTÄNDIGE CODE

**90101442700IP65**  
ROLLE

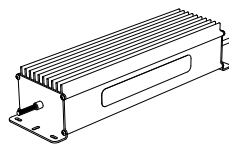

### DRIVERS 24V ON/OFF

<b>AE003A</b>	Driver 30W - On/Off 24V / IP20	<b>29,00 €</b>
<b>AE003B</b>	Driver 75W - On/Off 24V / IP20	<b>45,00 €</b>
<b>AE003C</b>	Driver 100W - On/Off 24V / IP65	<b>74,00 €</b>
<b>AE003D</b>	Driver 150W - On/Off 24V / IP65	<b>98,00 €</b>
<b>AE003E</b>	Driver 240W - On/Off 24V / IP65	<b>127,00 €</b>

### DRIVERS 24V TRIAC

<b>AE005A</b>	Driver 100W - Triac 24V / IP20	<b>124,00 €</b>
<b>AE005B</b>	Driver 200W - Triac 24V / IP65	<b>198,00 €</b>

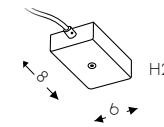

### AM002A

Solo collegamento elettrico rettangolo  
Only electrical connection rectangle  
Nur elektrische Verbindung Rechteck

**28,00 €**

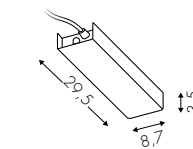

### 9010XS

Può contenere alimentatore: 30W/75W-24VDC  
It can contains power supply: 30W/75W-24VDC  
Es kann Netzteil enthalten: 30W/75W-24VDC

**72,00 €**

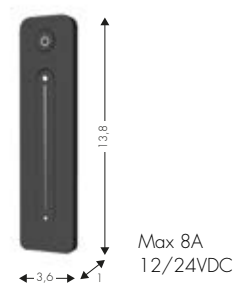

### DIMMER (Alimentatore escluso)

**9010SMARTMD** **74,00 €**

**9010SMARTRGB** **86,00 €**

Dispositivo per la gestione di sorgenti led con Radiocomando.  
Led light remote control.  
Gerät für die Verwaltung Led-Lichtquellen mit Fernsteuerung.

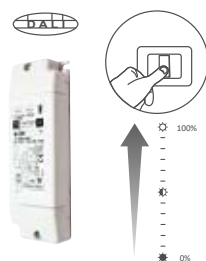

**90106002** **79,00 €**

Dispositivo per la gestione di sorgenti led a luce monocromatica con Pulsante o con sistema Domotico DALI.  
Monochromatic led light manager with button or DALI domotic system.  
Gerät für die Verwaltung von monochromatischem Led-Lichtquellen mit Druckknopfschaltung oder DALI Domotik.



**9010BTMD** **163,00 €**

Da utilizzare con Dimmer 90106002 (non incluso)  
Mit Dimmer 90106002 (nicht enthalten)  
With Dimmer 90106002 (not included)

Dispositivo Bluetooth per rendere dimmerabili Wireless da remoto i nostri prodotti in versione "DM" (DALI).  
Our products DM dimmable (DALI) products are compatible with Tridonic module for remote bluetooth dimming.  
Bluetooth-Gerät, um unsere "DM" (DALI) Produkte Wireless dimmbar zu machen.

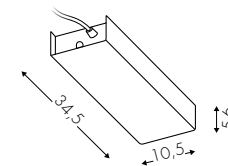

### 9010M

Può contenere alimentatore: 75W, 100W, 150W  
It can contains power supply: 75W, 100W, 150W  
Es kann Netzteil enthalten: 240W

**86,00 €**

75W + 90106002  
100W + 90106002  
150W + 90106002  
240W + 90106002

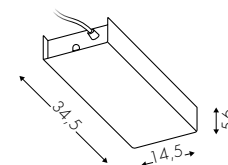

### 9010L

Può contenere alimentatore: 2x150W - 2x240W  
It can contains power supply: 2x150W - 2x240W  
Es kann Netzteil enthalten: 2x150W - 2x240W

**97,00 €**

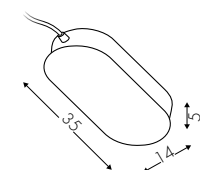

### AM004A

Può contenere alimentatore: 75W, 100W, 150W  
It can contains power supply: 75W, 100W, 150W  
Es kann Netzteil enthalten: 240W

**68,00 €**

75W + 90106002  
100W + 90106002  
150W + 90106002  
240W + 90106002

CODICE COMPLETO • COMPLETE CODE • VOLLSTÄNDIGE CODE

**AE003A**

Codice  
Code  
Code

CODICE COMPLETO • COMPLETE CODE • VOLLSTÄNDIGE CODE

**9010L** **BV**

Codice  
Code  
Code  
Finitura  
Finishing  
Lackierung



# Outdoor

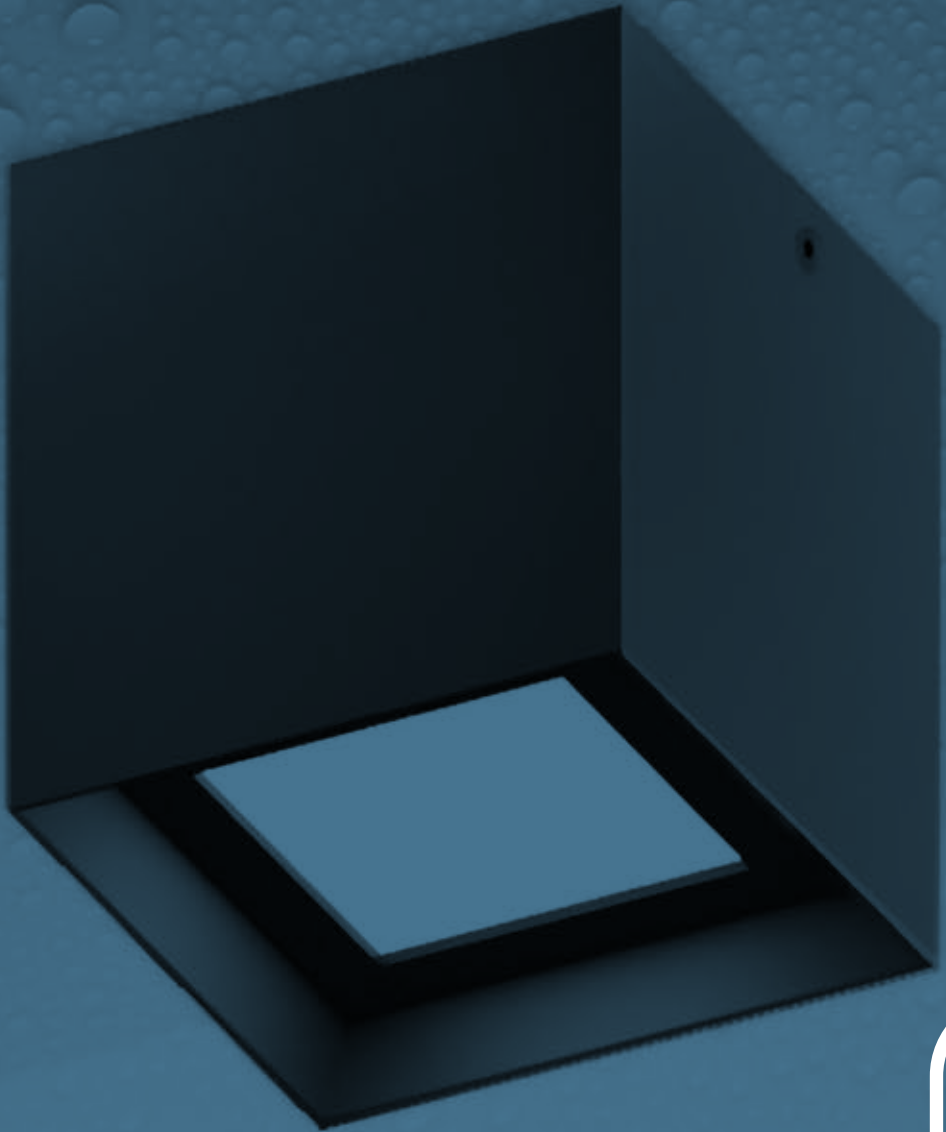



**Sospensione/Hanging lamp/Pendelleuchte**



**Bellai Outdoor**  
downlight Ø70/Ø95

369



**Leggera Outdoor**  
downlight Ø65/Ø82/Ø110/Ø160

371



**Mirò IP54**  
downlight (1-10mt)

373

**Plafone/Ceiling/Deckenleuchte**



**Bellai Outdoor**  
downlight Ø70/Ø95

375



**Iglù**  
downlight Ø25/Ø40

377



**Leggera Outdoor**  
downlight Ø65/Ø82

379



**Leggera Outdoor**  
downlight L170

381



**Mirò IP54**  
downlight (1-10mt)

383



**Oki Outdoor**  
downlight L8x8 H9/L15x15 H8  
L15x15 H17

385



**Oki Outdoor**  
downlight L8x8 H9

385



**Drop**  
orientabile [50-250cm]

386



**Wet Plus+**  
downlight 125/155cm

391

**Parete/Wall light/Wandleuchte**



**Flip**  
orientabile 8W

393

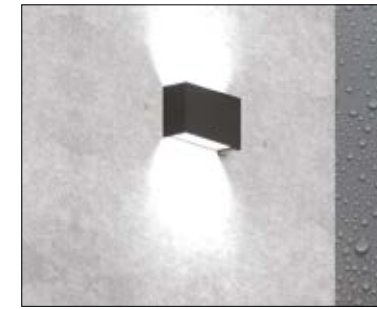

**Simply Outdoor**  
up+downlight L18

395

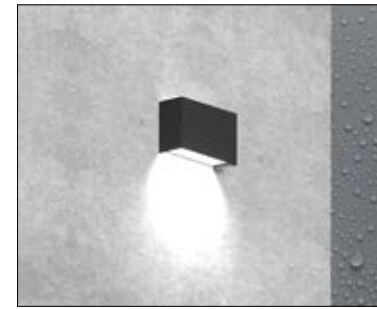

**Simply Outdoor**  
downlight L18

395

**Incasso/Recessed/Einbauchte**



**S-Pot Outdoor**  
downlight cartongesso Ø8-8W / Ø11-13W

397

**Fissaggio a terra/Ground fixing/Bodenbefestigung**



**Dot**  
uplight Ø4-1W

399



**Dot**  
uplight Ø5,6-3W

400



**Dot**  
uplight Ø7-7W

401



**Dot**  
laterale Asimmetrico-3W

403



**Dot**  
laterale Simmetrico-3W

405



**Flip 24V**  
orientabile 60cm/100cm 7W

407



**Flip 220V**  
orientabile (picchetto) 8W

409



configurazione standard: / basic configuration: / Standard Konfiguration:

E2 Opale - Opal

● B 3000K

BV

**1025AOF54BVE2B**

50W 3810lm\* - 220V

**1.501,00 €**

**1025ADM54BVE2B**

DALI (Push) - 50W 3810lm - 220V

**1.656,00 €**

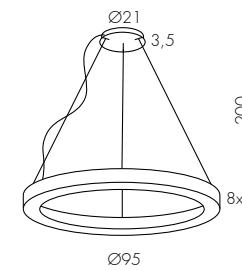
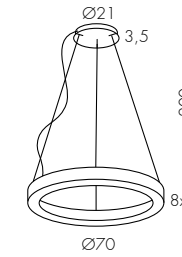

**1025BOF54BVE2B**

65W 5168lm - 220V

**1.891,00 €**

**1025BDM54BVE2B**

DALI (Push) - 65W 5168lm - 220V

**2.077,00 €**

Configura

Configure / Konfigurieren

[www.teamitaliailluminazione.it](http://www.teamitaliailluminazione.it)



● A 2700K

NE RU

**CODICE COMPLETO DEL PRODOTTO NELLA FOTO**  
FULL PRODUCT CODE AS SHOWN IN PICTURE - VOLLSTÄNDIGER CODE VOM ARTIKEL IM BILD

**1025AOF54** **NE** **E2** **B**

Codice  
Code

Finitura  
Finishing  
Lackierung

Diffusore  
Diffuser  
Diffusor

Tonalità  
Hue  
Farbton

BV NE RU

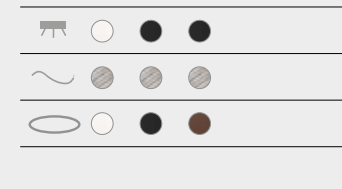

**A** Alimentatore Incorporato - Incorporated power supply - Eingebautes Netzteil

\* 3810lm effettivi - effective - effektive con - with - mit **E2**





# LEGGERA

SOSPENSIONE  
SUSPENSION LAMP  
PENDELLEUCHE



configurazione standard: / basic configuration: / Standard Konfiguration:

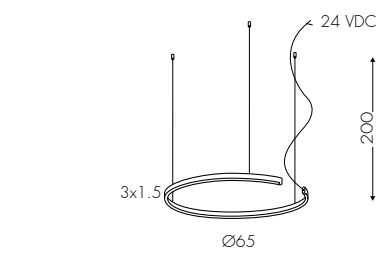

E2 Opale - Opal

B 3000K

BV



**1032A54BVE2B**

35W 1740lm\* - 24VDC

**575,00 €**

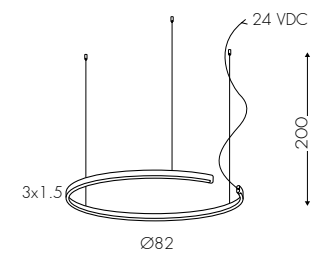

**1032B54BVE2B**

48W 2580lm - 24VDC

**697,00 €**

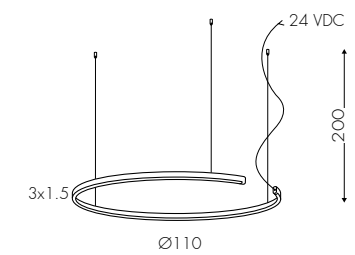

**1032C54BVE2B**

65W 3300lm - 24VDC

**820,00 €**

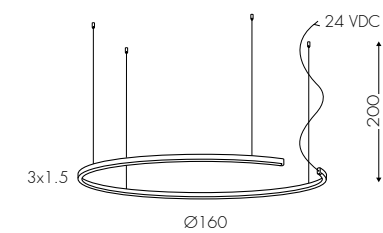

**1032D54BVE2B**

90W 4980lm - 24VDC

**1.308,00 €**

Configura

Configure / Konfigurieren

[www.teamitaliailluminazione.it](http://www.teamitaliailluminazione.it)



A 2700K

NE



**↑** CODICE COMPLETO DEL PRODOTTO NELLA FOTO  
FULL PRODUCT CODE AS SHOWN IN PICTURE · VOLLSTÄNDIGER CODE VOM ARTIKEL IM BILD

**1032D54** | **NE** | **E2** | **B**

Codice  
Code

Finitura  
Finishing  
Lackierung

Diffusore  
Diffuser  
Diffusor

Tonalità  
Hue  
Farbton

BV

NE

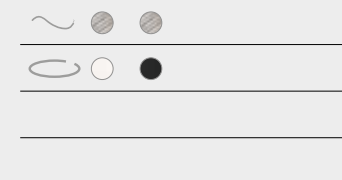

**⚡** Alimentatore non incluso - Power supply not included - Netzteil nicht inbegriffen

**Alimentatori IP65 a pag. 564-565 - IP65 Drivers p. 564-565 - Netzteil IP65 p. 564-565**

\* 1740lm effettivi - effective - effektive con - with - mit **E2**

INDEX

SECTION

FAMILY 371



# MIRÓ IP54 DOWNLIGHT (1-10mt)

SOSPENSIONE  
SUSPENSION LAMP  
PENDELLEUCHTE



configurazione standard: / basic configuration: / Standard Konfiguration:

E2 Opale - Opal

B 3000K

BV

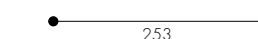
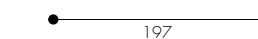
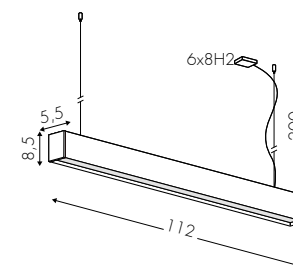

**1085BOFBVE2B**  
**1085BDMBVE2B**

25W 1910lm\* - 220V  
DALI (Push) - 25W 1910lm - 220V

**357,00 €**  
**413,00 €**

**1085EOFBVE2B**  
**1085EDMBVE2B**

44W 3350lm - 220V  
DALI (Push) - 44W 3350lm - 220V

**461,00 €**  
**522,00 €**

**1085GOFBVE2B**  
**1085GDMBVE2B**

56W 4305lm - 220V  
DALI (Push) - 56W 4305lm - 220V

**569,00 €**  
**616,00 €**

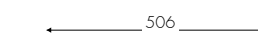
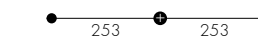
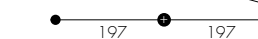
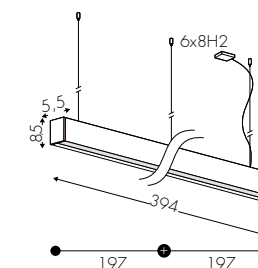

**1085LOFBVE2B**  
**1085LDMBVE2B**

87W 6705lm - 220V  
DALI (Push) - 87W 6705lm - 220V

**1.001,00 €**  
**1.150,00 €**

**1085MOFBVE2B**  
**1085MDMBVE2B**

111W 8605lm - 220V  
DALI (Push) - 111W 8605m - 220V

**1.174,00 €**  
**1.291,00 €**

**1085ROFBVE2B**  
**1085RDMBVE2B**

223W 17210lm - 220V  
DALI (Push) - 223W 17210lm - 220V

**2.593,00 €**  
**2.848,00 €**

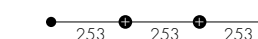

Configura

Configure / Konfigurieren

[www.teamitaliailluminazione.it](http://www.teamitaliailluminazione.it)



C 4000K

NE



**A** Alimentatore Incorporato - Incorporated Power Supply - Eingebautes Netzteil

\* 1910lm effettivi - effective - effektive con - with - mit E2

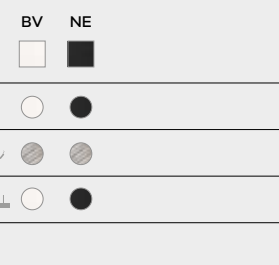

**CODICE COMPLETO DEL PRODOTTO NELLA FOTO**  
FULL PRODUCT CODE AS SHOWN IN PICTURE  
VOLLSTÄNDIGER CODE VOM ARTIKEL IM BILD

**1085EOF** **NE** **E2** **B**

Codice  
Code

Finitura  
Finishing  
Lackierung

Diffusore  
Diffuser  
Diffusor

Tonalità  
Hue  
Farbton

INDEX

SECTION

FAMILY 373





configurazione standard: / basic configuration: / Standard Konfiguration:

E2 Opale - Opal ● B 3000K

BV

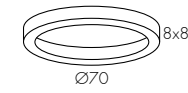

**3025AOF54BVE2B** 50W 3810lm\* - 220V 1.463,00 €  
**3025ADM54BVE2B** DALI (push) - 50W 3810lm - 220V 1.617,00 €

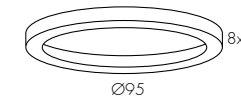

**3025BOF54BVE2B** 65W 5168lm - 220V 1.829,00 €  
**3025BDM54BVE2B** DALI (push) - 65W 5168lm - 220V 2.014,00 €

Configura  Configure / Konfigurieren

[www.teamitaliailluminazione.it](http://www.teamitaliailluminazione.it) 



● A 2700K

NE RU 

A Alimentatore Incorporato - Incorporated power supply - Eingebautes Netzteil

\* 3810lm effettivi - effective - effektive con - with - mit E2

 CODICE COMPLETO DEL PRODOTTO NELLA FOTO  
FULL PRODUCT CODE AS SHOWN IN PICTURE - VOLLSTÄNDIGER CODE VOM ARTIKEL IM BILD

**3025AOF54** **NE** **E2** **B**

Codice  
Code

Finitura  
Finishing  
Lackierung

Diffusore  
Diffuser  
Diffusor

Tonalità  
Hue  
Farbton





configurazione standard: / basic configuration: / Standard Konfiguration:

E2 Opale - Opal

● B 3000K

BV

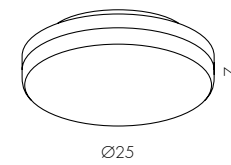

**3080BOFBVE2B**

12W 1300lm\* - 220V

**78,00 €**

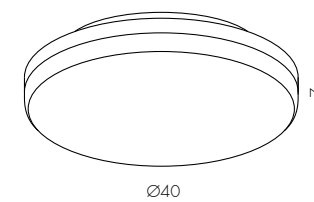

**3080DOFBVE2B**

30W 3000lm - 220V

**148,00 €**

Configura 

Configure / Konfigurieren

[www.teamitaliailluminazione.it](http://www.teamitaliailluminazione.it) 



A Alimentatore Incorporato - Incorporated Power Supply - Eingebautes Netzteil

\* 1300lm effettivi - effective - effektiven con - with - mit **E2**

 **CODICE COMPLETO DEL PRODOTTO NELLA FOTO**  
FULL PRODUCT CODE AS SHOWN IN PICTURE - VOLLSTÄNDIGER CODE VOM ARTIKEL IM BILD

**3080DOF** **BV** **E2** **B**

Codice Code	Finitura Finishing Lackierung	Diffusore Diffuser Diffusor	Tonalità Hue Farbton
----------------	-------------------------------------	-----------------------------------	----------------------------



# LEGGERA

PLAFONE  
CEILING LIGHT  
DECKENLEUCHTE



configurazione standard: / basic configuration: / Standard Konfiguration:

E2 Opale - Opal

B 3000K

BV

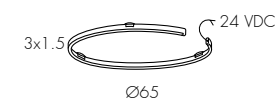

**3032A54BVE2B**

35W 1740lm\* - 24VDC

**575,00 €**

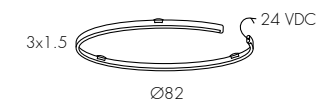

**3032B54BVE2B**

48W 2580lm - 24VDC

**697,00 €**

Configura

Configure / Konfigurieren

[www.teamitaliailluminazione.it](http://www.teamitaliailluminazione.it)



A 2700K

NE



**CODICE COMPLETO DEL PRODOTTO NELLA FOTO**  
FULL PRODUCT CODE AS SHOWN IN PICTURE - VOLLSTÄNDIGER CODE VOM ARTIKEL IM BILD

**3032B54** | **NE** | **E2** | **B**

Codice  
Code

Finitura  
Finishing  
Lackierung

Diffusore  
Diffuser  
Diffusor

Tonalità  
Hue  
Farbton

Alimentatore non incluso - Power supply not included - Netzteil nicht inbegriffen

**Alimentatori IP65 a pag. 564-565 - IP65 Drivers p. 564-565 - Netzteil IP65 p. 564-565**

\* 1740lm effettivi - effective - effektive con - with - mit **E2**

INDEX

SECTION

FAMILY 379



configurazione standard: / basic configuration: / Standard Konfiguration:

E2 Opale - Opal

B 3000K

BV

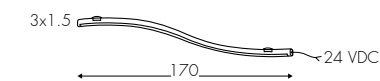

**3032G54BVE2B**

35W 1740lm\* - 24VDC

**487,00 €**



Configura

Configure / Konfigurieren

[www.teamitaliailluminazione.it](http://www.teamitaliailluminazione.it)



A 2700K

NE



**CODICE COMPLETO DEL PRODOTTO NELLA FOTO**  
FULL PRODUCT CODE AS SHOWN IN PICTURE - VOLLSTÄNDIGER CODE VOM ARTIKEL IM BILD

**3032G54** | **NE** | **E2** | **B**

Codice  
Code

Finitura  
Finishing  
Lackierung

Diffusore  
Diffuser  
Diffusor

Tonalità  
Hue  
Farbton

Alimentatore non incluso - Power supply not included - Netzteil nicht inbegriffen

**Alimentatori IP65 a pag. 564-565 - IP65 Drivers p. 564-565 - Netzteil IP65 p. 564-565**

\* 1740lm effettivi - effective - effektive con - with - mit **E2**

# MIRÓ IP54

PLAFONE  
CEILING LIGHT  
DECKENLEUCHTE



configurazione standard: / basic configuration: / Standard Konfiguration:

E2 Opale - Opal

B 3000K

BV

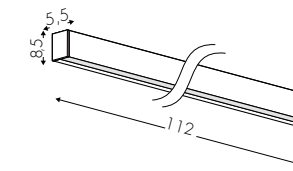

**3085BOFBVE2B**  
**3085BDMBVE2B**

25W 1910lm\* - 220V  
DALI (Push) - 25W 1910lm - 220V

**355,00 €**  
**410,00 €**

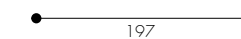

**3085EOFBVE2B**  
**3085EDMBVE2B**

44W 3350lm - 220V  
DALI (Push) - 44W 3350lm - 220V

**482,00 €**  
**542,00 €**

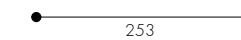

**3085GOFBVE2B**  
**3085GDMBVE2B**

56W 4305lm - 220V  
DALI (Push) - 56W 4305lm - 220V

**589,00 €**  
**636,00 €**

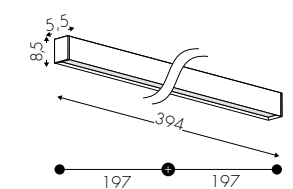

**3085LOFBVE2B**  
**3085LDMBVE2B**

87W 6705lm - 220V  
DALI (Push) - 87W 6705lm - 220V

**1.059,00 €**  
**1.209,00 €**



**3085MOFBVE2B**  
**3085MDMBVE2B**

111W 8605lm - 220V  
DALI (Push) - 111W 8605lm - 220V

**1.224,00 €**  
**1.342,00 €**



**3085ROFBVE2B**  
**3085RDMBVE2B**

223W 17210lm - 220V  
DALI (Push) - 223W 17210lm - 220V

**2.607,00 €**  
**2.943,00 €**

Configura

Configure / Konfigurieren

[www.teamitaliailluminazione.it](http://www.teamitaliailluminazione.it)



C 4000K

NE

**A** Alimentatore Incorporato - Incorporated Power Supply - Eingebautes Netzteil

\* 1910lm effettivi - effective - effektive con - with - mit **E2**

**↑** CODICE COMPLETO DEL PRODOTTO NELLA FOTO  
FULL PRODUCT CODE AS SHOWN IN PICTURE  
VOLLSTÄNDIGER CODE VOM ARTIKEL IM BILD

**3085EOF** **NE** **E2** **B**

Codice  
Code

Finitura  
Finishing  
Lackierung

Diffusore  
Diffuser  
Diffusor

Tonalità  
Hue  
Farbton

INDEX

SECTION

FAMILY 383





configurazione standard: / basic configuration: / Standard Konfiguration:

E28 Satinato  
Frosted - Satiniert ● B 3000K BV

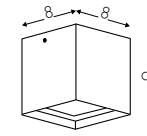

**3009AOF54BVE28B** 13W 1000lm\* - 220V **180,00 €**

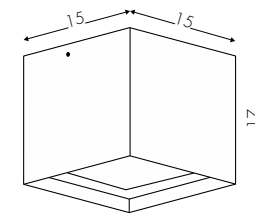

**3009COF54BVE28B** 20W 1700lm - 220V **299,00 €**

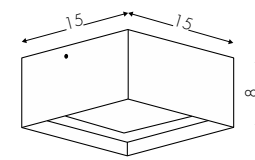

**3009DOF54BVE28B** 20W 1700lm - 220V **269,00 €**

Configura Configure / Konfigurieren

[www.teamitaliailluminazione.it](http://www.teamitaliailluminazione.it)



C 4000K

NE RU

configurazione standard: / basic configuration: / Standard Konfiguration:

E28 Satinato  
Frosted - Satiniert ● B 3000K BV

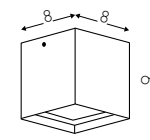

**3009P54BVE28B** 9W 900lm - 24VDC **221,00 €**

**24V**

Configura Configure / Konfigurieren

[www.teamitaliailluminazione.it](http://www.teamitaliailluminazione.it)



C 4000K

NE RU

**CODICE COMPLETO DEL PRODOTTO NELLA FOTO**  
FULL PRODUCT CODE AS SHOWN IN PICTURE - VOLLSTÄNDIGER CODE VOM ARTIKEL IM BILD

**3009AOF54** **NE** **E28** **B**

Codice  
Code

Finitura  
Finishing  
Lackierung

Diffusore  
Diffuser  
Diffusor

Tonalità  
Hue  
Farbton

Alimentatore Incorporato - Incorporated Power Supply - Eingebautes Netzteil

Alimentatore non incluso - Power Supply not included - Netzteil nicht inbegriffen

**Alimentatori IP65 a pag. 564-565 - IP65 Drivers p. 564-565 - Netzteil IP65 p. 564-565**

\* 1000lm effettivi - effective - effektive con - with - mit **E28**

## 22W/mt



6010DV13	50cm 22W/mt 2300lm/mt - 24VDC	171,00 €
6010DV23	100cm 22W/mt 2300lm/mt - 24VDC	222,00 €
6010DV33	150cm 22W/mt 2300lm/mt - 24VDC	298,00 €
6010DV43	200cm 22W/mt 2300lm/mt - 24VDC	378,00 €
6010DV53	250cm 22W/mt 2300lm/mt - 24VDC	454,00 €

## 14.4W/mt



6010DV11	50cm 14.4W/mt 1600lm* /mt - 24VDC	150,00 €
6010DV21	100cm 14.4W/mt 1600lm/mt - 24VDC	186,00 €
6010DV31	150cm 14.4W/mt 1600lm/mt - 24VDC	244,00 €
6010DV41	200cm 14.4W/mt 1600lm/mt - 24VDC	305,00 €
6010DV51	250cm 14.4W/mt 1600lm/mt - 24VDC	356,00 €



ACCIAIO CROMATO  
CHROME STEEL  
CHROMSTAHL

AISI 303



L30 Lente 30° - Lens 30° - Linse 30°  
L220 Lente 220° - Lens 220° - Linse 220°  
E2 Opale - Opal

A 2700K  B 3000K  C 4000K



L30 Lente 30° - Lens 30° - Linse 30°  
L220 Lente 220° - Lens 220° - Linse 220°  
E2 Opale - Opal

A 2700K  B 3000K  C 4000K  E RGB

Configura  Configure / Konfigurieren

[www.teamitaliailluminazione.it](http://www.teamitaliailluminazione.it) 

 Alimentatore non incluso - Power Supply not included - Netzteil nicht inbegriffen  
**Alimentatori IP65 a pag. 564-565 - IP65 Drivers p. 564-565 - Netzteil IP65 p. 564-565**

\* 1600lm effettivi - effective - effektive con - with - mit L220 - 1600lm -15% con - with - mit E2

CODICE COMPLETO • COMPLETE CODE • VOLLSTÄNDIGE CODE

**6010DV13** | **B** | **L30**

Codice  
Code

Finitura  
Finishing  
Lackierung

Diffusore  
Diffuser  
Diffusor



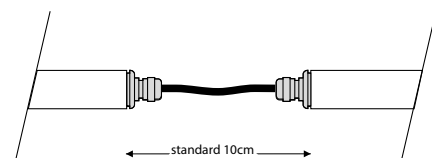

**001005A**  
Servizio collegamento in serie  
Line-up connection service  
Reihenschaltung Service

56,00 €

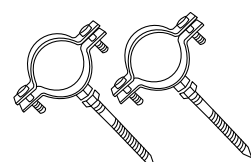

**90106010**  
Coppia Collare antieffrazione  
Couple anti-theft collar  
Paar Anti-Diebstahl Kragen

14,00 €

ACCIAIO ZINCATO  
GALVANIZED STEEL  
VERZINKTEM STAHL

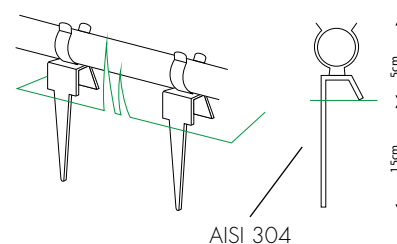

**90106008**  
Coppia picchetti INOX - Orizzontale  
Couple INOX stakes for fied - horizontal  
Paar INOX Pflöcke für Rasen - horizontal

67,00 €

AISI 304

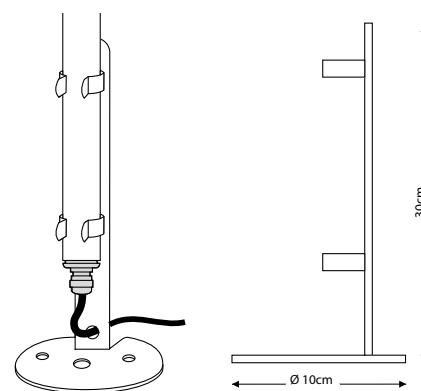

**90106009**  
Coppia picchetti INOX - Verticale  
Single INOX stake - vertical  
Einzeppflock INOX - vertikal

65,00 €

AISI 304

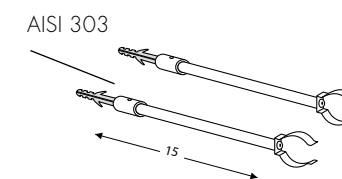

**6010DSF15**  
coppia staffe inox 15cm  
Couple of 15cm inox brackets  
Paar 15 cm Edelstahlbügel

83,00 €

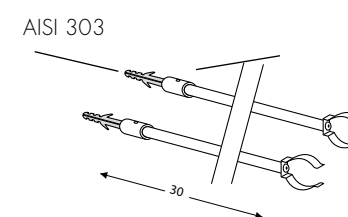

**6010DSF30**  
coppia staffe inox 30cm  
Couple of 30 cm inox brackets  
Paar 30 cm Edelstahlbügel

114,00 €

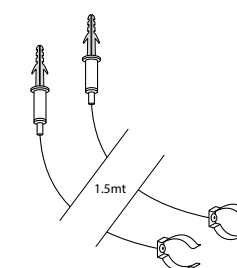

**6010DSOSP**  
Kit sospensione DROP360  
Pendant KIT DROP360  
Pendel KIT DROP360

50,00 €

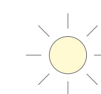

**CTT250FEP**  
Aggiunta cavo 1 mt - 2 poli - fep+gomma Ø5,3  
1 mt adding cable - 2 poles - fep+rubber  
1 mt Kabel hinzugefügt - 2 Pole - fep+Gummi

14,00 €

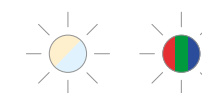

**CTT450FEP**  
Aggiunta cavo 1 mt - 4 poli - fep+gomma Ø5,8  
1 mt adding cable - 4 poles - fep+rubber  
1 mt Kabel hinzugefügt - 4 Pole - fep+Gummi

25,00 €

Configura  Configure / Konfigurieren

[www.teamitaliailluminazione.it](http://www.teamitaliailluminazione.it) 





# WET PLUS+

PLAFONE  
CEILING LIGHT  
DECKENLEUCHE



configurazione standard: / basic configuration: / Standard Konfiguration:

E2 Opale - Opal

C 4000K

GV

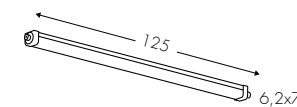

**3079BOFGVE2C**  
**3079BDMGVE2C**

48W 6500lm\* - 220V

DALI (Push) - 50W 5900lm - 220V

**134,00 €**

**249,00 €**

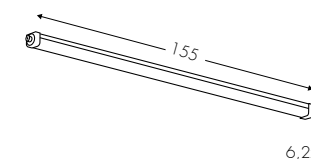

**3079COFGVE2C**  
**3079CDMGVE2C**

75W 10000lm - 220V

DALI (Push) - 60W 8200lm - 220V

**157,00 €**

**318,00 €**

Configura

Configure / Konfigurieren

[www.teamitaliailluminazione.it](http://www.teamitaliailluminazione.it)



**CODICE COMPLETO DEL PRODOTTO NELLA FOTO**  
FULL PRODUCT CODE AS SHOWN IN PICTURE - VOLLSTÄNDIGER CODE VOM ARTIKEL IM BILD

**3079BOF**

Codice  
Code

**GV**

Finitura  
Finishing  
Lackierung

**E2**

Diffusore  
Diffuser  
Diffusor

**C**

Tonalità  
Hue  
Farbton

**A** Alimentatore Incorporato - Incorporated Power Supply - Eingebautes Netzteil

\* 6500lm effettivi - effective - effektive con - with - mit **E2**

INDEX

SECTION

FAMILY 391

configurazione standard: / basic configuration: / Standard Konfiguration:

24° Ottica - Optic - Optik ● B 3000K

NE



**2043AOFNE24B** 8W 815lm\* - 220V

**161,00 €**

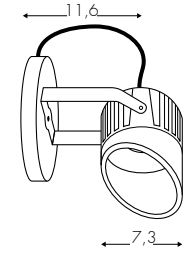

Configura  Configure / Konfigurieren

[www.teamitaliailluminazione.it](http://www.teamitaliailluminazione.it) 



A Alimentatore Incorporato - Incorporated Power Supply - Eingebautes Netzteil

\* 815lm effettivi - effective - effektive con - with - mit 24°



 **CODICE COMPLETO DEL PRODOTTO NELLA FOTO**  
FULL PRODUCT CODE AS SHOWN IN PICTURE - VOLLSTÄNDIGER CODE VOM ARTIKEL IM BILD

**2043AOF** **NE** **24** **B**

Codice  
Code

Finitura  
Finishing  
Lackierung



Diffusore  
Diffuser  
Diffusor

Tonalità  
Hue  
Farbton



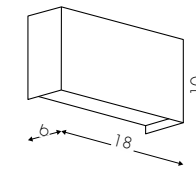
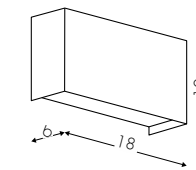

configurazione standard: / basic configuration: / Standard Konfiguration:

E28 Satinato  
Frosted - Satiniert B 3000KBV  
**2019EOF54BVE28B** 18W 1280lm\* - 220V**217,00 €**[Configura](#)  Configure / Konfigurieren[www.teamitaliailluminazione.it](http://www.teamitaliailluminazione.it) **2019FOF54BVE28B** 9W 640lm - 220V**182,00 €**[Configura](#)  Configure / Konfigurieren[www.teamitaliailluminazione.it](http://www.teamitaliailluminazione.it) NE RU  
**A** Alimentatore Incorporato - Incorporated Power Supply - Eingebautes Netzteil\*1280lm effettivi - effective - effektive con - with - mit **E28** **CODICE COMPLETO DEL PRODOTTO NELLA FOTO**  
FULL PRODUCT CODE AS SHOWN IN PICTURE - VOLLSTÄNDIGER CODE VOM ARTIKEL IM BILD**2019EOF54** **NE** **E28** **B**Codice  
CodeFinitura  
Finishing  
LackierungDiffusore  
Diffuser  
DiffusorTonalità  
Hue  
Farbton





configurazione standard: / basic configuration: / Standard Konfiguration:

60° Ottica  
Optic - Optik

B 3000K

BV

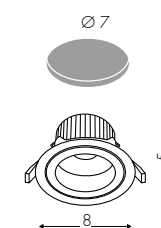

4017QOFBV60B

8W 860lm\* - 220V

102,00 €

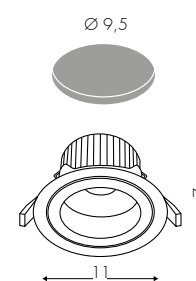

4017ROFBV60B

13W 1320lm - 220V

114,00 €

Configura

Configure / Konfigurieren

[www.teamitaliailluminazione.it](http://www.teamitaliailluminazione.it)



C 4000K

Alimentatore Incluso in remoto - Remote Power Supply - Fernspeisung enthalten

\* 860lm effettivi - effective - effektive con - with - mit 60°



CODICE COMPLETO DEL PRODOTTO NELLA FOTO  
FULL PRODUCT CODE AS SHOWN IN PICTURE - VOLLSTÄNDIGER CODE VOM ARTIKEL IM BILD

**4017QOF**

Codice  
Code

**BV**

Finitura  
Finishing  
Lackierung

**60**

Diffusore  
Diffuser  
Diffusor

**B**

Tonalità  
Hue  
Farbton





configurazione standard: / basic configuration: / Standard Konfiguration:

24° Ottica  
Optic - Optik

● B 3000K

AL ■

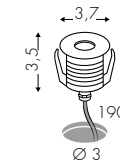

**4042AAL24B**

1W 120lm\* - 350mA 3V

**55,00 €**

Alimentatore - Power supply - Netzteil

**AE006I**

OnOff 4W 350mA / 1-3 art.4042A

**13,00 €**

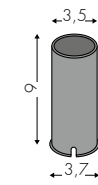

**9042A**

Controcassa - Outer Casing - Einbauhülse

**12,00 €**

Configura

Configure / Konfigurieren

[www.teamitaliailluminazione.it](http://www.teamitaliailluminazione.it)



Alimentatore non incluso - Power Supply not included - Netzteil nicht inbegriffen

\* 120lm effettivi - effective - effektive con - with - mit 24°



**CODICE COMPLETO DEL PRODOTTO NELLA FOTO**  
FULL PRODUCT CODE AS SHOWN IN PICTURE - VOLLSTÄNDIGER CODE VOM ARTIKEL IM BILD

**4042A**

Codice  
Code

**AL**

Finitura  
Finishing  
Lackierung

**24**

Diffusore  
Diffuser  
Diffusor

**B**

Tonalità  
Hue  
Farbton







configurazione standard: / basic configuration: / Standard Konfiguration:

24° Ottica  
Optic - Optik ● B 3000K AL

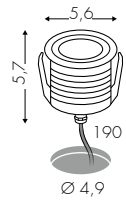

<b>4042BAL24B</b>	3W 360lm - 350mA 9V	<b>82,00 €</b>
Alimentatore - Power supply - Netzteil		
<b>AE006M</b>	OnOff 18W 350mA / 1-5 art.4042B	<b>59,00 €</b>

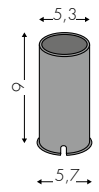

<b>9042B</b>	Controcassa - Outer Casing - Einbauhülse	<b>12,00 €</b>
--------------	--	----------------

configurazione standard: / basic configuration: / Standard Konfiguration:

24° Ottica  
Optic - Optik ● B 3000K AL

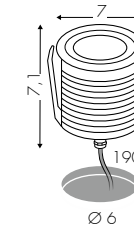

<b>4042CAL24B</b>	7W 840lm* - 350mA 20V	<b>95,00 €</b>
Alimentatore - Power supply - Netzteil		
<b>AE006M</b>	OnOff 18W 350mA / 2 art.4042C	<b>59,00 €</b>

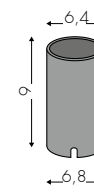

<b>9042C</b>	Controcassa - Outer Casing - Einbauhülse	<b>12,00 €</b>
--------------	--	----------------

Configura Configure / Konfigurieren

[www.teamitaliailluminazione.it](http://www.teamitaliailluminazione.it)



Configura Configure / Konfigurieren

[www.teamitaliailluminazione.it](http://www.teamitaliailluminazione.it)



CODICE COMPLETO • COMPLETE CODE • VOLLSTÄNDIGE CODE

<b>4042B</b>	<b>AL</b>	<b>24</b>	<b>B</b>
Codice Code	Finitura Finishing Lackierung	Diffusore Diffuser Diffusor	Tonalità Hue Farbton

Alimentatore non incluso - Power Supply not included  
Netzteil nicht inbegriffen

\* 840lm effettivi - effective - effektive con - with - mit 24°

INDEX

SECTION

FAMILY







configurazione standard: / basic configuration: / Standard Konfiguration:

24° Ottica  
Optic - Optik

● B 3000K

AL ■

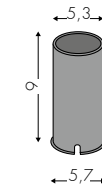
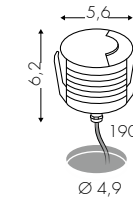

**4042DAL24B**

3W 360lm\* - 350mA 9V

**61,00 €**

Alimentatore - Power supply - Netzteil

**AE006M**

OnOff 18W 350mA / 3-5 art.4042D

**59,00 €**

**9042B**

Controcassa - Outer Casing - Einbauhülse

**12,00 €**

Configura

Configure / Konfigurieren

[www.teamitaliailluminazione.it](http://www.teamitaliailluminazione.it)



**CODICE COMPLETO DEL PRODOTTO NELLA FOTO**  
FULL PRODUCT CODE AS SHOWN IN PICTURE - VOLLSTÄNDIGER CODE VOM ARTIKEL IM BILD

**4042D**

Codice  
Code

**AL**

Finitura  
Finishing  
Lackierung

**24**

Diffusore  
Diffuser  
Diffusor

**B**

Tonalità  
Hue  
Farbton

Alimentatore non incluso - Power Supply not included - Netzteil nicht inbegriffen

\* 360lm effettivi - effective - effektive con - with - mit 24°





configurazione standard: / basic configuration: / Standard Konfiguration:

24° Ottica  
Optic - Optik

● B 3000K

AL ■

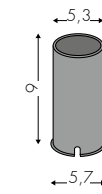
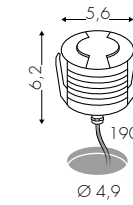

**4042EAL24B**

3W 360lm\* - 350mA 9V

**61,00 €**

Alimentatore - Power supply - Netzteil

**AE006M**

OnOff 18W 350mA / 3-5 art.4042E

**59,00 €**

**9042B**

Controcassa - Outer Casing - Einbauhülse

**12,00 €**

Configura

Configure / Konfigurieren

[www.teamitaliailluminazione.it](http://www.teamitaliailluminazione.it)



**CODICE COMPLETO DEL PRODOTTO NELLA FOTO**  
FULL PRODUCT CODE AS SHOWN IN PICTURE - VOLLSTÄNDIGER CODE VOM ARTIKEL IM BILD

**4042E**

Codice  
Code

**AL**

Finitura  
Finishing  
Lackierung

**24**

Diffusore  
Diffuser  
Diffusor

**B**

Tonalità  
Hue  
Farbton

Alimentatore non incluso - Power Supply not included - Netzteil nicht inbegriffen

\* 360lm effettivi - effective - effektive con - with - mit 24°









configurazione standard: / basic configuration: / Standard Konfiguration:

24° Ottica  
Optic - Optik

B 3000K

NE



5043AOFNE24B

8W 815lm\* - 220V

125,00 €

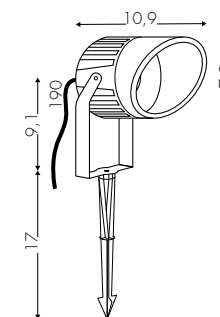

Configura

Configure / Konfigurieren

[www.teamitaliailluminazione.it](http://www.teamitaliailluminazione.it)



CODICE COMPLETO DEL PRODOTTO NELLA FOTO  
FULL PRODUCT CODE AS SHOWN IN PICTURE - VOLLSTÄNDIGER CODE VOM ARTIKEL IM BILD

**5043AOF** **NE** **24** **B**

Codice  
Code

Finitura  
Finishing  
Lackierung

Diffusore  
Diffuser  
Diffusor

Tonalità  
Hue  
Farbton

Alimentatore Incorporato - Incorporated Power Supply - Eingebautes Netzteil

\* 815lm effettivi - effective - effektive con - with - mit 24°



Sistemi modulari  
Modular systems  
Modulare Systeme





Sospensione/Hanging lamp/Pendelleuchte



**Emme24**  
downlight [1-3m] **421**

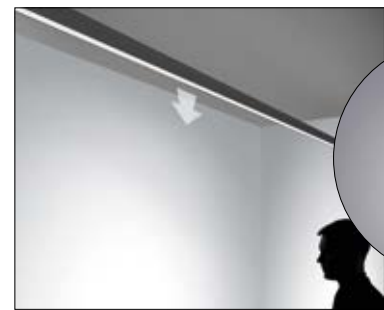

**Emme24**  
downlight [3-10m] **423**



L4,3xH6,5



**Emme24**  
downlight giunzione L59x59 **425**



**Emme24**  
downlight curva R46 **425**



**M-Eco**  
up+downlight [1-3m] **427**



**M-Eco**  
up+downlight [3-10m] **429**

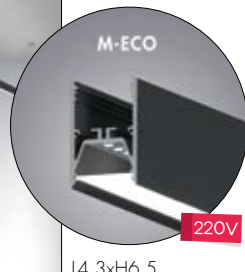

L4,3xH6,5



**M-Eco**  
downlight sospensione giunzione "L" **431**



**M-Eco**  
downlight sospensione giunzione "T" **431**

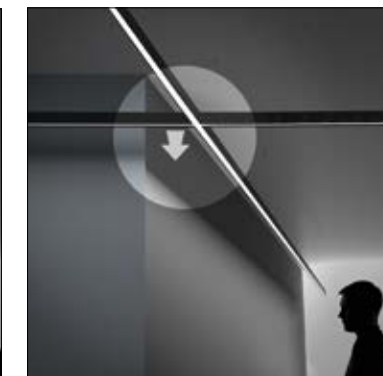

**M-Eco**  
downlight sospensione giunzione "+" **431**



**Mirò**  
up+downlight [1-3m] **435**



**Mirò**  
up+downlight [3-10m] **437**

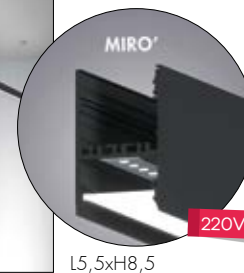

L5,5xH8,5



**Mirò**  
downlight [1-3m] **439**



**Mirò**  
downlight [3-10m] **441**



**Mirò**  
darklight L56/L84/L120 **451**



**Mirò**  
orientabile spotlight 2x7W/3x7W /4x7W **443**



**Mirò**  
up+downlight L197/L225/L253 **443**



**Mirò**  
no-light L84/L112/L140 **445**



**Mirò**  
no-light giunzione "L"/"T"/"+" **449**



**Mirò**  
downlight sospensione giunzione "L" **447**



**Mirò**  
downlight sospensione giunzione "T" **447**



**Mirò**  
downlight sospensione giunzione "+" **447**



Plafone/Ceiling/Deckenleuchte



**Emme24** 453  
downlight [1-3mf]



**Emme24** 455  
downlight [3-10mf]

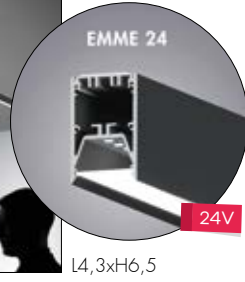

**Emme24** 455  
downlight giunzione L59x59



**M-Eco** 457  
downlight [1-3mf]



**M-Eco** 459  
downlight [3-10mf]

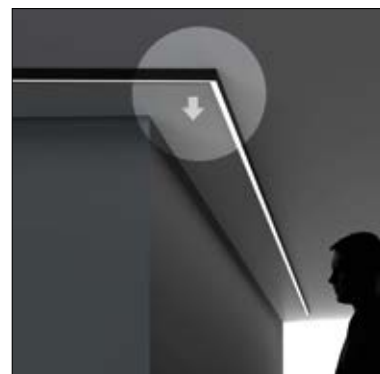

**M-Eco** 461  
downlight sospensione giunzione "L"



**M-Eco** 461  
downlight sospensione giunzione "T"

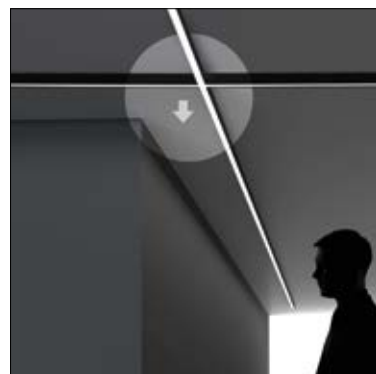

**M-Eco** 461  
downlight sospensione giunzione "+"



**Mirò** 465  
downlight [1-3mf]



**Mirò** 467  
downlight [3-10mf]



**Mirò** 469  
no-light L84/L112/L140

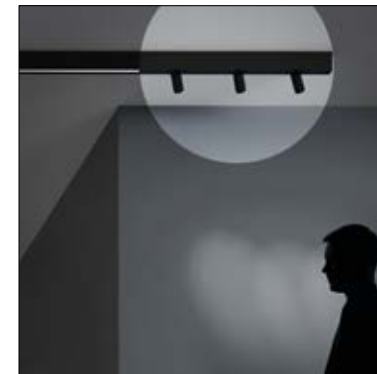

**Mirò** 471  
orientabile spotlight 2x7W/3x7W/4x7W

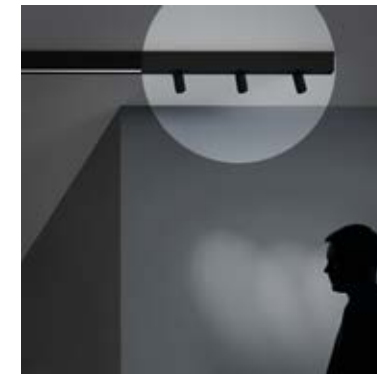

**Mirò** 471  
orientabile spotlight L197/L225/L253



**Mirò** 477  
darklight 56/84/120

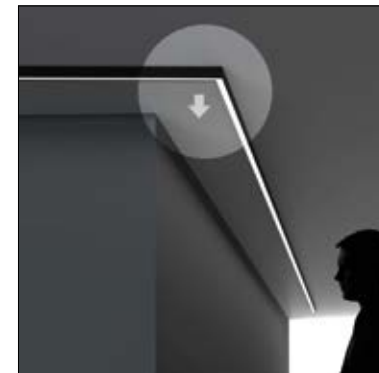

**Mirò** 473  
downlight plafone giunzione "L"

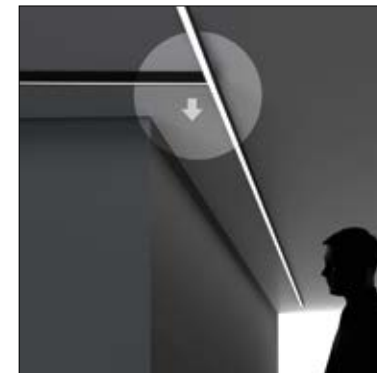

**Mirò** 473  
downlight plafone giunzione "T"



**Mirò** 473  
downlight plafone giunzione "+"



**Mirò** 475  
no-light giunzione "L"/"T"/"+"

Parete/Wall light/Wandeleuchte



**Mirò** 479-481  
up+downlight [2mt-10mt]

Incasso/Recessed/Einbauchte



**Emme24** 483-485  
downlight cartongesso [1-10mt]



**Emme24** 487  
downlight cartongesso L59x59/L56x31  
L59x59vert

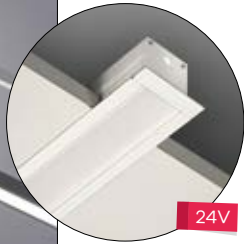

**Mirò** 489-491  
downlight cartongesso [1-10mt]



**Mirò** 493  
downlight cartongesso L59x59/L56.x31  
L59x59vert



Binario/Track/Elektrofizierte Stromschiene



**M-Eco** 495  
downlight L60/L112/L140/L253



**M-Eco** 497  
downlight L112/L140/L253

## EMME 24 EXAMPLES OF COMPOSITION

Gli elementi Emme24 a 24VDC possono essere abbinati liberamente in funzione delle necessità progettuali; la composizione può essere alimentata tramite PowerUnit on-off o dimmerabile opportunamente dimensionata.

Emme24 24VDC elements can be freely combined according to the design needs; the composition can be powered by an appropriately sized on-off PowerUnit or Dimmable.

Die 24VDC Emme24-Elemente können je nach Plan Bedürfnissen frei kombiniert werden; die Zusammensetzung kann durch angemessene On/off oder dimmbares Netzteil bedient werden.

### COMPOSIZIONE CODICI DI ACQUISTO CODES COMPOSITION ZUSAMMENSETZUNG DES CODES

1pz 1037MBVE2B  
1pz 9037BTFBV

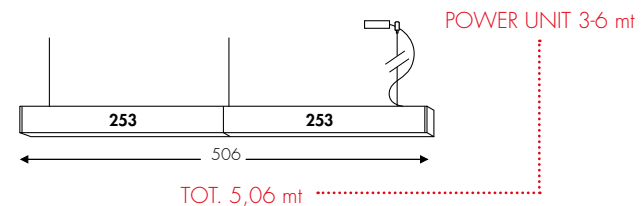

### COMPOSIZIONE CODICI DI ACQUISTO CODES COMPOSITION ZUSAMMENSETZUNG DES CODES

1pz 1037LBVE2B  
1pz 1037KGABVE2B  
1pz 1037EBVE2B  
1pz 9037CDM

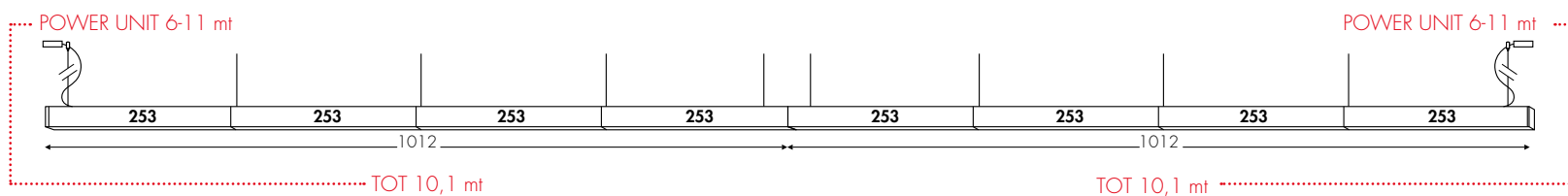
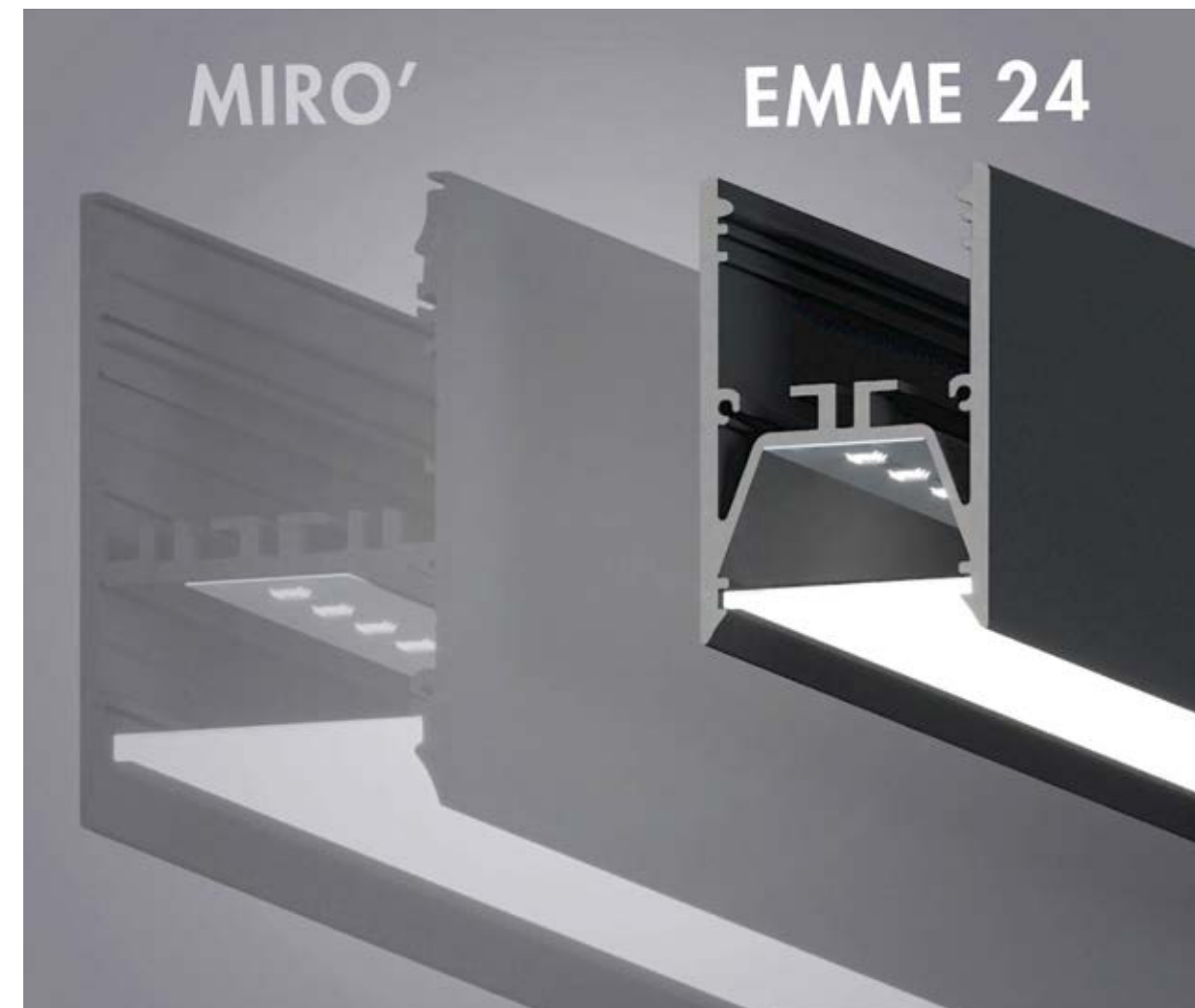
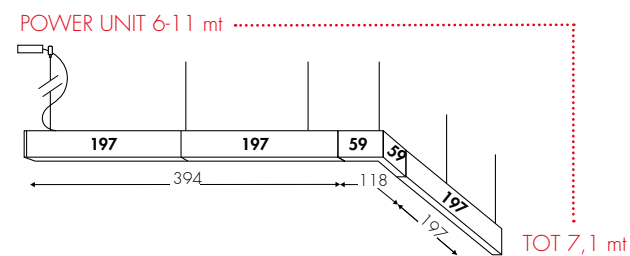

### COMPOSIZIONE CODICI DI ACQUISTO CODES COMPOSITION ZUSAMMENSETZUNG DES CODES

2pz 1037RNEE2B  
2pz 9037COF

5,5 x H 8,3cm

3160lm/mt  
220VAC

Moduli led rigidi/Rigid led modules/  
starre LED-Module

Driver incorporato/built-in driver/eingebauter Treiber

4,3 x H 6,5cm

2000lm/mt  
24VDC

Moduli led rigidi/Rigid led modules/  
starre LED-Module

Driver Onoff - DALI escluso remoto/  
Onoff driver - DALI excluded remotely/  
Driver Onoff - DALI aus der Ferne ausgeschlossen



# EMME 24 DOWNLIGHT (1-3mt)

SOSPENSIONE  
SUSPENSION LAMP  
PENDELLEUCHE

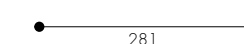
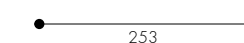
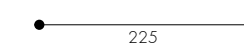
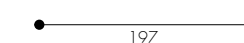
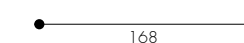
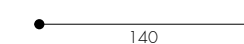
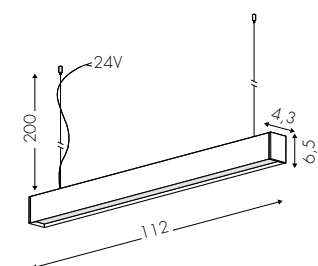

configurazione standard: / basic configuration: / Standard Konfiguration:

E2 Opale - Opal ● B 3000K BV

**1037BBVE2B** 25W 1910lm\* - 24VDC **262,00 €**

**1037CBVE2B** 31W 2385lm - 24VDC **278,00 €**

**1037DBVE2B** 37W 2860lm - 24VDC **299,00 €**

**1037EBVE2B** 44W 3350lm - 24VDC **317,00 €**

**1037FBVE2B** 50W 3830lm - 24VDC **348,00 €**

**1037GBVE2B** 56W 4305lm - 24VDC **370,00 €**

**1037HBVE2B** 62W 4780lm - 24VDC **395,00 €**

Configura Configure / Konfigurieren

[www.teamitaliailluminazione.it](http://www.teamitaliailluminazione.it)



✗ E19 UGR<19 Prism  C 4000K

NE

**CODICE COMPLETO DEL PRODOTTO NELLA FOTO**  
FULL PRODUCT CODE AS SHOWN IN PICTURE - VOLLSTÄNDIGER CODE VOM ARTIKEL IM BILD

**1037E**

Codice  
Code

**BV**

Finitura  
Finishing  
Lackierung

**E2**

Diffusore  
Diffuser  
Diffusor

**B**

Tonalità  
Hue  
Farbton

✗ Alimentatore non incluso - Power Supply not included - Netzteil nicht inbegriffen  
**Alimentatori a pag. 564-565 - Drivers p. 564-565 - Netzteil p. 564-565**

\* 1910lm effettivi - effective - effektive con - with - mit **E2**  
2240lm effettivi - effective - effektive con - with - mit **E19** ↻ +17,5%

# EMME 24 DOWNLIGHT (3-10mt)

SOSPENSIONE  
SUSPENSION LAMP  
PENDELLEUCHTE



configurazione standard: / basic configuration: / Standard Konfiguration:

E2 Opale - Opal

● B 3000K

BV

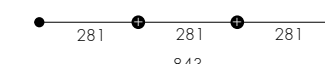
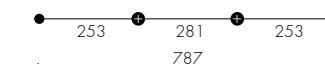
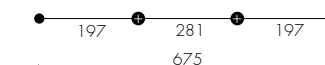
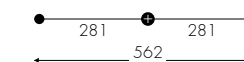
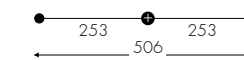
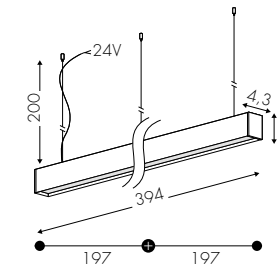

**1037LBVE2B** 87W 6705lm\* - 24VDC **700,00 €**

**1037MBVE2B** 111W 8605lm - 24VDC **760,00 €**

**1037NBVE2B** 124W 9560lm - 24VDC **873,00 €**

**1037OBVE2B** 148,5W 11485lm - 24VDC **1.157,00 €**

**1037PBVE2B** 173W 13380lm - 24VDC **1.298,00 €**

**1037QBVE2B** 185W 14340lm - 24VDC **1.358,00 €**

**1037RBVE2B** 223W 17210lm - 24VDC **1.743,00 €**

Configura

Configure / Konfigurieren

[www.teamitaliailluminazione.it](http://www.teamitaliailluminazione.it)



E19 UGR<19 Prism

C 4000K

NE



**CODICE COMPLETO DEL PRODOTTO NELLA FOTO**  
FULL PRODUCT CODE AS SHOWN IN PICTURE - VOLLSTÄNDIGER CODE VOM ARTIKEL IM BILD

**1037KGR** **NE** **E2** **B**

Codice  
Code

Finitura  
Finishing  
Lackierung

Diffusore  
Diffuser  
Diffusor

Tonalità  
Hue  
Farbton

Alimentatore non incluso - Power Supply not included - Netzteil nicht inbegriffen  
**Alimentatori a pag. 564-565 - Drivers p. 564-565 - Netzteil p. 564-565**

\* 6705lm effettivi - effective - effektive con - with - mit **E2**  
7880lm effettivi - effective - effektive con - with - mit **E19** **+17,5%**



BV NE

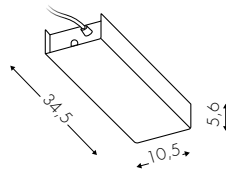

0-3 METRI

**9037AOF** 75W - 220V  
**9037ADM** DALI (Push) - 75W - 220V  
**9037ATF** 75W - 220V

**130,00 €**  
**218,00 €**  
**179,00 €**

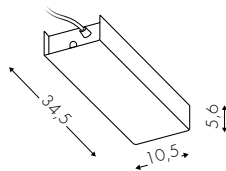

3-6 METRI

**9037BOF** 150W - 220V  
**9037BDM** DALI (Push) - 150W - 220V  
**9037BTF** 150W - 220V

**174,00 €**  
**262,00 €**  
**221,00 €**

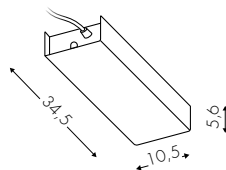

6-11 METRI

**9037COF** 240W - 220V  
**9037CDM** DALI (Push) - 240W - 220V

**228,00 €**  
**318,00 €**

Configura Configure / Konfigurieren

[www.teamitaliailluminazione.it](http://www.teamitaliailluminazione.it)



**A** Alimentatore Incorporato - Incorporated Power Supply - Eingebautes Netzteil

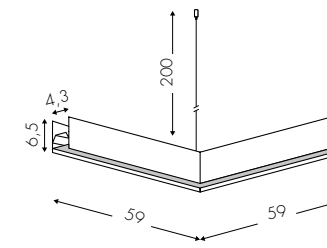

configurazione standard: / basic configuration: / Standard Konfiguration:

E2 Opale - Opal B 3000K

BV

**1037KGABVE2B** 25W 1905lm\* - 24VDC

**345,00 €**

Configura Configure / Konfigurieren

[www.teamitaliailluminazione.it](http://www.teamitaliailluminazione.it)

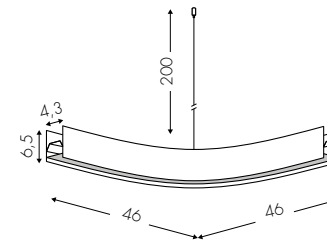

**1037KGRBVE2B** 18W 1235lm - 24VDC

**345,00 €**

Configura Configure / Konfigurieren

[www.teamitaliailluminazione.it](http://www.teamitaliailluminazione.it)



E19 UGR<19 Prism C 4000K

NE

**A** Alimentatore non incluso - Power Supply not included - Netzteil nicht inbegriffen  
**Alimentatori a pag. 564-565 - Drivers p. 564-565 - Netzteil p. 564-565**

\* 1905lm effettivi - effective - effektive con - with - mit **E2**  
2240lm effettivi - effective - effektive con - with - mit **E19** +17,5%





configurazione standard: / basic configuration: / Standard Konfiguration:

E2 Opale - Opal

B 3000K

BV

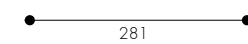
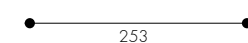
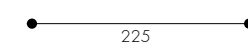
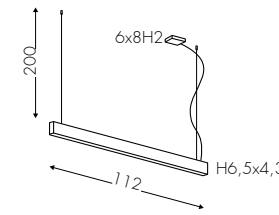

**1058BOFBVE2B**  
**1058BDMBVE2B**

18W 2025lm\* + 8W 1100lm - 220V  
DALI (Push) - 18W 2025lm + 8W 1100lm - 220V

**304,00 €**  
**365,00 €**

**1058COFBVE2B**  
**1058CDMBVE2B**

22W 2530lm + 8W 1100lm - 220V  
DALI (Push) - 22W 2530lm + 8W 1100lm - 220V

**329,00 €**  
**388,00 €**

**1058DOFBVE2B**  
**1058DDMBVE2B**

26W 3040lm + 16W 2200lm - 220V  
DALI (Push) - 26W 3040lm + 16W 2200lm - 220V

**356,00 €**  
**430,00 €**

**1058EOFBVE2B**  
**1058EDMBVE2B**

31W 3540lm + 16W 2200lm - 220V  
DALI (Push) - 31W 3540lm + 16W 2200lm - 220V

**376,00 €**  
**430,00 €**

**1058FOFBVE2B**  
**1058FDMBVE2B**

34W 4010lm + 16W 2200lm - 220V  
DALI (Push) - 34W 4010lm + 16W 2200lm - 220V

**424,00 €**  
**498,00 €**

**1058GOFBVE2B**  
**1058GDMBVE2B**

39W 4520lm + 16W 2200lm - 220V  
DALI (Push) - 39W 4520lm + 16W 2200lm - 220V

**463,00 €**  
**534,00 €**

**1058HOFBVE2B**  
**1058HDMBVE2B**

43W 5080lm + 16W 2200lm - 220V  
DALI (Push) - 43W 5080lm + 16W 2200lm - 220V

**530,00 €**  
**604,00 €**

Configura

Configure / Konfigurieren

[www.teamitaliailluminazione.it](http://www.teamitaliailluminazione.it)



E19 UGR<19 Prism

A 2700K  C 4000K

NE RU



**CODICE COMPLETO DEL PRODOTTO NELLA FOTO**  
FULL PRODUCT CODE AS SHOWN IN PICTURE - VOLLSTÄNDIGER CODE VOM ARTIKEL IM BILD

**1058DOF** **NE** **E2** **B**

Codice  
Code

Finitura  
Finishing  
Lackierung

Diffusore  
Diffuser  
Diffusor

Tonalità  
Hue  
Farbton

BV NE RU

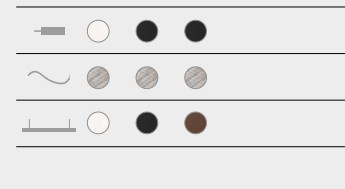

Alimentatore Incorporato - Incorporated Power Supply - Eingebautes Netzteil

\* 2025lm effettivi - effective - effektive con - with - mit **E2**  
2380lm effettivi - effective - effektive con - with - mit **E19** **+17,5%**



configurazione standard: / basic configuration: / Standard Konfiguration:

E2 Opale - Opal

B 3000K

BV

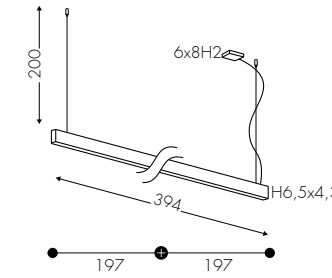

**1058LOFBVE2B**  
**1058LDMBVE2B**

62W 7080lm\* + 32W 4400lm - 220V  
DALI (Push) - 62W 7080lm + 32W 4400lm - 220V

**766,00 €**  
**877,00 €**

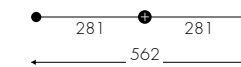

**1058MOFBVE2B**  
**1058MDMBVE2B**

78W 9010lm + 32W 4400lm - 220V  
DALI (Push) - 78W 9010lm + 32W 4400lm - 220V

**944,00 €**  
**1.088,00 €**

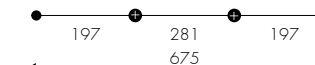

**1058NOFBVE2B**  
**1058NDMBVE2B**

86W 10155lm + 32W 4400lm - 220V  
DALI (Push) - 86W 10155lm + 32W 4400lm - 220V

**1.080,00 €**  
**1.231,00 €**

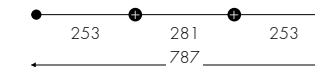

**1058OOFBVE2B**  
**1058ODMBVE2B**

105W 12160lm + 48W 6600lm - 220V  
DALI (Push) - 105W 12160lm + 48W 6600lm - 220V

**1.306,00 €**  
**1.492,00 €**

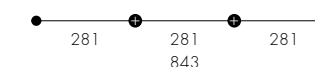

**1058POFBVE2B**  
**1058PDMBVE2B**

121W 14095lm + 48W 6600lm - 220V  
DALI (Push) - 121W 14095lm + 48W 6600lm - 220V

**1.483,00 €**  
**1.704,00 €**



**1058QOFBVE2B**  
**1058QDMBVE2B**

129W 15230lm + 48W 6600lm - 220V  
DALI (Push) - 129W 15230lm + 48W 6600lm - 220V

**1.620,00 €**  
**1.847,00 €**

**1058ROFBVE2B**  
**1058RDMBVE2B**

156W 18030lm + 64W 8800lm - 220V  
DALI (Push) - 156W 18030lm + 64W 8800lm - 220V

**1.887,00 €**  
**2.176,00 €**

Configura

Configure / Konfigurieren

[www.teamitaliailluminazione.it](http://www.teamitaliailluminazione.it)



E19 UGR<19 Prism

A 2700K  C 4000K

NE RU

**CODICE COMPLETO DEL PRODOTTO NELLA FOTO**  
FULL PRODUCT CODE AS SHOWN IN PICTURE - VOLLSTÄNDIGER CODE VOM ARTIKEL IM BILD

**1058OOF** **NE** **E2** **B**

Codice  
Code

Finitura  
Finishing  
Lackierung

Diffusore  
Diffuser  
Diffusor

Tonalità  
Hue  
Farbton

BV NE RU

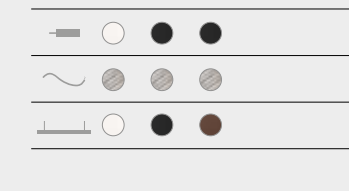

**A** Alimentatore Incorporato - Incorporated Power Supply - Eingebautes Netzteil

\* 7080lm effettivi - effective - effektive con - with - mit **E2**  
8330lm effettivi - effective - effektive con - with - mit **E19** **+17,5%**



configurazione standard: / basic configuration: / Standard Konfiguration:

E2 Opale - Opal

B 3000K

BV

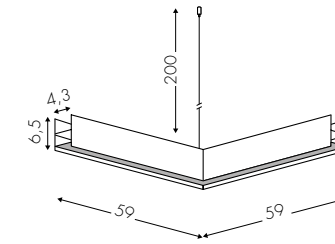

**1058KGAOFBVE2B** 18W 2025lm\* - 220V **454,00 €**  
**1058KGADMBVE2B** DALI (Push) - 18W 2025lm - 220V **520,00 €**

Configura Configura / Konfigurieren

[www.teamitaliailluminazione.it](http://www.teamitaliailluminazione.it)

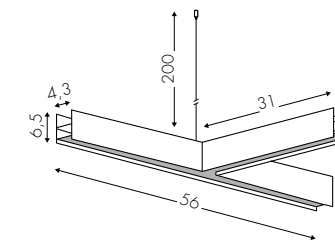

**1058KGTDFBVE2B** 14W 1575lm - 220V **563,00 €**  
**1058KGTDMBVE2B** DALI (Push) - 14W 1575lm - 220V **634,00 €**

Configura Configura / Konfigurieren

[www.teamitaliailluminazione.it](http://www.teamitaliailluminazione.it)

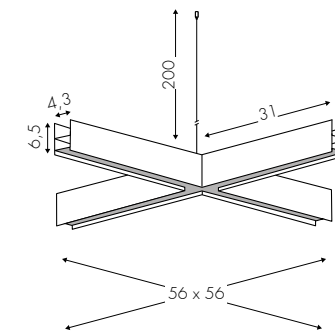

**1058KGCDFBVE2B** 18W 2025lm - 220V **741,00 €**  
**1058KGCDFBVE2B** DALI (Push) - 18W 2025lm - 220V **817,00 €**

Configura Configura / Konfigurieren

[www.teamitaliailluminazione.it](http://www.teamitaliailluminazione.it)



E19 UGR<19 Prism  A 2700K  C 4000K

NE RU



**CODICE COMPLETO DEL PRODOTTO NELLA FOTO**  
**FULL PRODUCT CODE AS SHOWN IN PICTURE - VOLLSTÄNDIGER CODE VOM ARTIKEL IM BILD**

**1058GAOF** **NE** **E2** **B**

Codice Code	Finitura Finishing Lackierung	Diffusore Diffuser Diffusor	Tonalità Hue Farbton
----------------	-------------------------------------	-----------------------------------	----------------------------

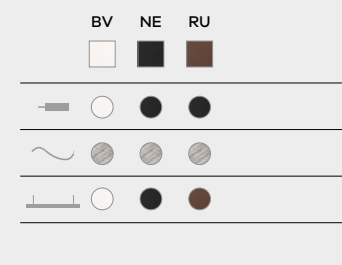

Alimentatore Incorporato - Incorporated Power Supply - Eingebautes Netzteil

\* 2025lm effettivi - effective - effektive con - with - mit **E2**  
 2380lm effettivi - effective - effektive con - with - mit **E19** **+17,5%**





**Up+Downlight**

<b>112cm</b>	<b>140cm</b>	<b>168cm</b>	<b>197cm</b>	<b>225cm</b>	<b>253cm</b>	<b>281cm</b>
1030B	1030C	1030D	1030E	1030F	1030G	1030H
<b>394cm</b>	<b>506cm</b>	<b>562cm</b>	<b>675cm</b>	<b>787cm</b>	<b>843cm</b>	<b>1012cm</b>
1030L	1030M	1030N	1030O	1030P	1030Q	1030R



**Downlight**

<b>112cm</b>	<b>140cm</b>	<b>168cm</b>	<b>197cm</b>	<b>225cm</b>	<b>253cm</b>	<b>281cm</b>
1034B	1034C	1034D	1034E	1034F	1034G	1034H
<b>394cm</b>	<b>506cm</b>	<b>562cm</b>	<b>675cm</b>	<b>787cm</b>	<b>843cm</b>	<b>1012cm</b>
1034L	1034M	1034N	1034O	1034P	1034Q	1034R



**Uplight**

<b>140cm</b>	<b>168cm</b>	<b>197cm</b>	<b>225cm</b>	<b>253cm</b>	<b>281cm</b>
1035C	1035D	1035E	1035F	1035G	1035H
<b>394cm</b>	<b>506cm</b>	<b>562cm</b>	<b>675cm</b>	<b>787cm</b>	<b>843cm</b>
1035L	1035M	1035N	1035O	1035P	1035Q



**Geometrical element downlight**

<b>59x59cm</b>	<b>56x31cm</b>	<b>56x56cm</b>
1030KGA	1030KGT	1030KGC

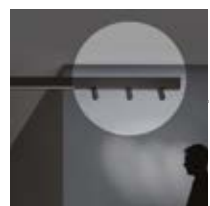

**Spotlight**

<b>56cm</b>	<b>84cm</b>	<b>112cm</b>	<b>197cm</b>	<b>225cm</b>	<b>253cm</b>
1030S2	1030S3	1030S4	1030S5	1030S6	1030S7



**Darklight**

<b>56cm</b>	<b>84cm</b>	<b>120cm</b>
1046Z	1046A	1046B



**No-light**

<b>84cm</b>	<b>112cm</b>	<b>140cm</b>
1036A	1036B	1036C

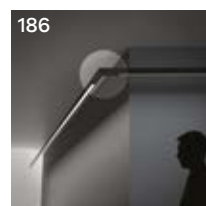

186



**Geometrical element No-light**

<b>17x17cm</b>	<b>28x17cm</b>	<b>28x28cm</b>
1036KGA	1036KGT	1036KGC

- OF DM
- BV NE
- E2 E19
- 24°
- B 3000K
- C 4000K

- OF DM
- BV NE
- 24°
- B 3000K

- OF DM
- BV NE

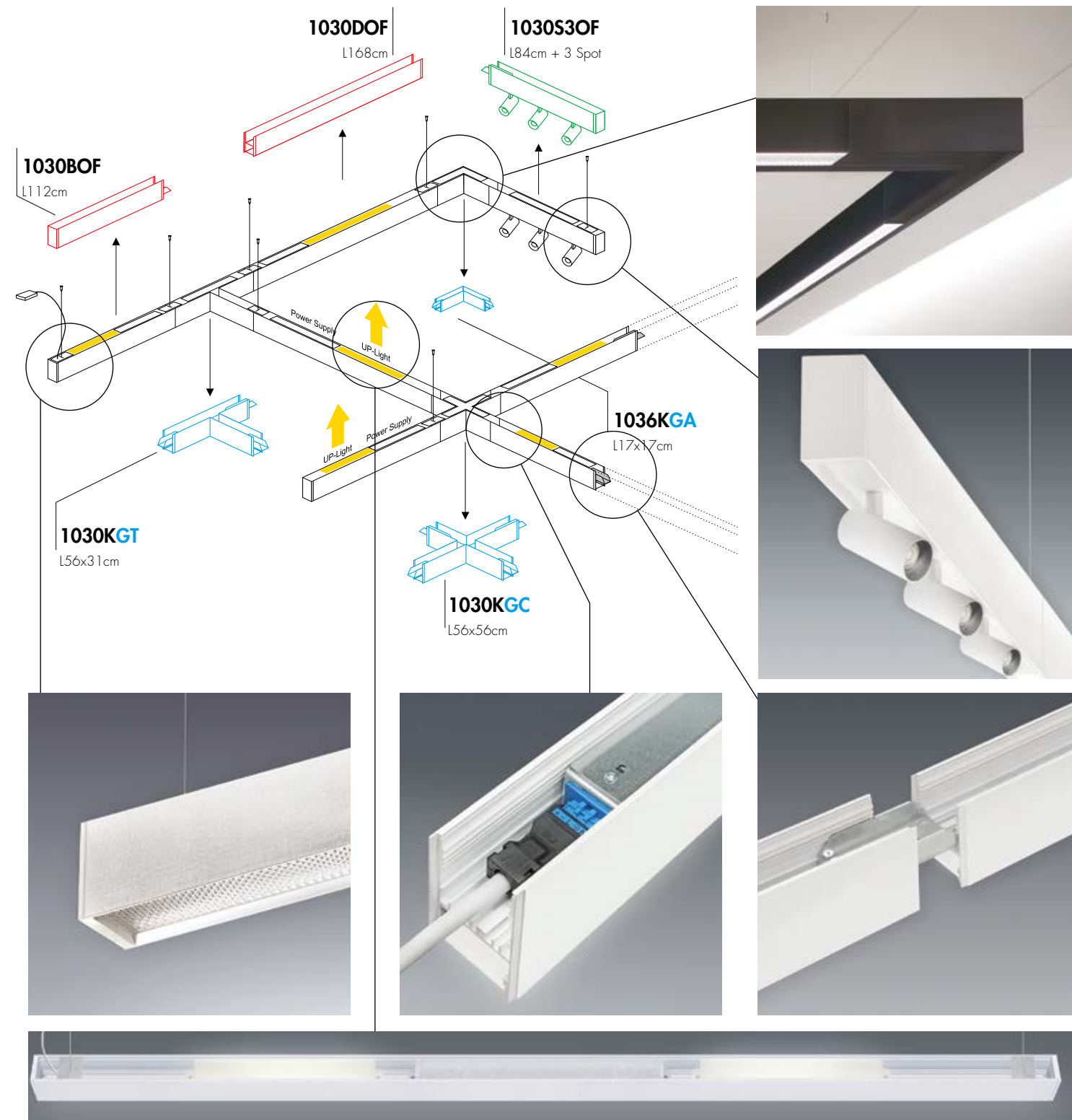



configurazione standard: / basic configuration: / Standard Konfiguration:

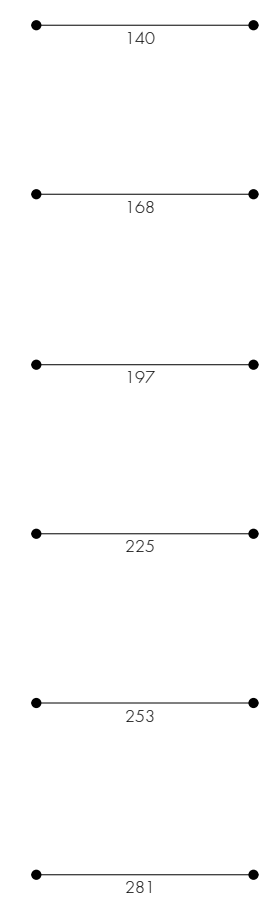
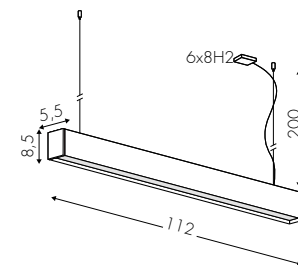

Model	Specifications	Price (€)
E2 Opale - Opal	B 3000K	
1030BOFBVE2B	35W 3010lm* + 18W 2390lm - 220V	397,00
1030BDMBVE2B	DALI (Push) - 35W 3010lm + 18W 2390lm - 220V	454,00
1030BTFBVE2B	35W 3010lm + 18W 2390lm - 220V	454,00
1030COFBVE2B	44W 3765lm + 18W 2390lm - 220V	430,00
1030CDMBVE2B	DALI (Push) - 44W 3765lm + 18W 2390lm - 220V	488,00
1030CTFBVE2B	44W 3765lm + 18W 2390lm - 220V	488,00
1030DOFBVE2B	53W 4515lm + 18W 2390lm - 220V	474,00
1030DDMBVE2B	DALI (Push) - 53W 4515lm + 18W 2390lm - 220V	534,00
1030DTFBVE2B	53W 4515lm + 18W 2390lm - 220V	534,00
1030EOFBVE2B	62W 5265lm + 18W 2390lm - 220V	542,00
1030EDMBVE2B	DALI (Push) - 62W 5265lm + 18W 2390lm - 220V	604,00
1030ETFBVE2B	62W 5265lm + 18W 2390lm - 220V	604,00
1030FOFBVE2B	70W 6020lm + 18W 2390lm - 220V	599,00
1030FDMBVE2B	DALI (Push) - 70W 6020lm + 18W 2390lm - 220V	663,00
1030FTFBVE2B	70W 6020lm + 18W 2390lm - 220V	663,00
1030GOFBVE2B	79W 6775lm + 18W 2390lm - 220V	652,00
1030GDMBVE2B	DALI (Push) - 79W 6775lm + 18W 2390lm - 220V	700,00
1030GTFBVE2B	79W 6775lm + 18W 2390lm - 220V	700,00
1030HOFBVE2B	88W 7525lm + 18W 2390lm - 220V	707,00
1030HDMBVE2B	DALI (Push) - 88W 7525lm + 18W 2390lm - 220V	758,00
1030HTFBVE2B	88W 7525lm + 18W 2390lm - 220V	758,00

Configura Configure / Konfigurieren

[www.teamitaliailluminazione.it](http://www.teamitaliailluminazione.it)



E19 UGR<19 Prism C 4000K



CODICE COMPLETO DEL PRODOTTO NELLA FOTO  
FULL PRODUCT CODE AS SHOWN IN PICTURE - VOLLSTÄNDIGER CODE VOM ARTIKEL IM BILD

**1030BOF** **NE** **E19** **B**

Codice Code  
Finitura Finishing Lackierung  
Diffusore Diffuser Diffusor  
Tonalità Hue Farbton

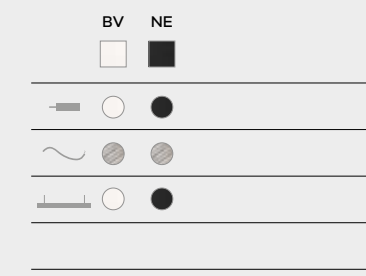

**TF** Taglio di Fase - Phase-Cut Dimmer - Erhältlich Phasenabschnittdimmer  
**A** Alimentatore Incorporato - Incorporated Power Supply - Eingebautes Netzteil

\* 3010lm effettivi - effective - effektive con - with - mit **E2**  
3540lm effettivi - effective - effektive con - with - mit **E19** +17,5%





configurazione standard: / basic configuration: / Standard Konfiguration:

E2 Opale - Opal

B 3000K

BV

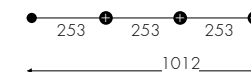
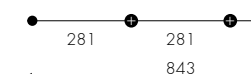
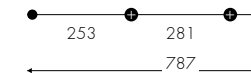
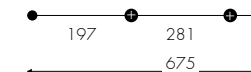
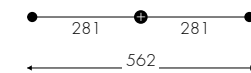
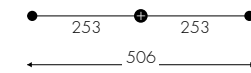
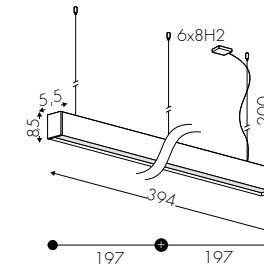

<b>1030LOFBVE2B</b>	123W 10530lm* + 36W 4782lm - 220V	<b>1.139,00</b> €
<b>1030LDMBVE2B</b>	DALI (Push) - 123W 10530lm + 36W 4782lm - 220V	<b>1.293,00</b> €
<b>1030LTFBVE2B</b>	123W 10530lm + 36W 4782lm - 220V	<b>1.293,00</b> €
<b>1030MOFBVE2B</b>	158W 13550lm + 36W 4782lm - 220V	<b>1.312,00</b> €
<b>1030MDMBVE2B</b>	DALI (Push) - 158W 13550lm + 36W 4782lm - 220V	<b>1.433,00</b> €
<b>1030MTFBVE2B</b>	158W 13550lm + 36W 4782lm - 220V	<b>1.433,00</b> €
<b>1030NOFBVE2B</b>	176W 15050lm + 36W 4782lm - 220V	<b>1.437,00</b> €
<b>1030NDMBVE2B</b>	DALI (Push) - 176W 15050lm + 36W 4782lm - 220V	<b>1.562,00</b> €
<b>1030NTFBVE2B</b>	176W 15050lm + 36W 4782lm - 220V	<b>1.562,00</b> €
<b>1030OOFBVE2B</b>	212W 18060lm + 54W 7173lm - 220V	<b>1.847,00</b> €
<b>1030ODMBVE2B</b>	DALI (Push) - 212W 18060lm + 54W 7173lm - 220V	<b>2.071,00</b> €
<b>1030OTFBVE2B</b>	212W 18060lm + 54W 7173lm - 220V	<b>2.071,00</b> €
<b>1030POFBVE2B</b>	246W 21070lm + 54W 7173lm - 220V	<b>2.141,00</b> €
<b>1030PDMBVE2B</b>	DALI (Push) - 246W 21070lm + 54W 7173lm - 220V	<b>2.347,00</b> €
<b>1030PTFBVE2B</b>	246W 21070lm + 54W 7173lm - 220V	<b>2.347,00</b> €
<b>1030QOFBVE2B</b>	264W 22575lm + 54W 7173lm	<b>2.366,00</b> €
<b>1030QDMBVE2B</b>	DALI (Push) - 264W 22575lm + 54W 7173lm	<b>2.600,00</b> €
<b>1030QTFBVE2B</b>	264W 22575lm + 54W 7173lm	<b>2.600,00</b> €
<b>1030ROFBVE2B</b>	317W 27090lm + 70W 9564lm - 220V	<b>2.952,00</b> €
<b>1030RDMBVE2B</b>	DALI (Push) - 317W 27090lm + 70W 9564lm - 220V	<b>3.182,00</b> €
<b>1030RTFBVE2B</b>	317W 27090lm + 70W 9564lm - 220V	<b>3.182,00</b> €

Configura

Configure / Konfigurieren

[www.teamitaliailluminazione.it](http://www.teamitaliailluminazione.it)



E19 UGR<19 Prism

C 4000K

NE

**CODICE COMPLETO DEL PRODOTTO NELLA FOTO**  
FULL PRODUCT CODE AS SHOWN IN PICTURE - VOLLSTÄNDIGER CODE VOM ARTIKEL IM BILD

**1030LOF** **NE** **E19** **B**

Codice  
Code

Finitura  
Finishing  
Lackierung

Diffusore  
Diffuser  
Diffusor

Tonalità  
Hue  
Farbton

BV

NE

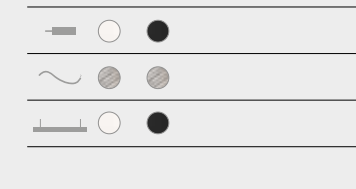

**TF** Taglio di Fase - Phase-Cut Dimmer - Erhältlich Phasenabschnittdimmer

**A** Alimentatore Incorporato - Incorporated Power Supply - Eingebautes Netzteil

\* 10530lm effettivi - effective - effektive con - with - mit **E2**  
12390lm effettivi - effective - effektive con - with - mit **E19** **+17,5%**





configurazione standard: / basic configuration: / Standard Konfiguration:

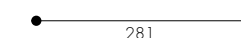
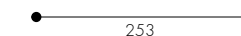
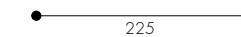
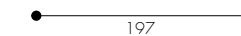
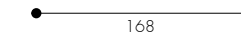
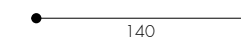
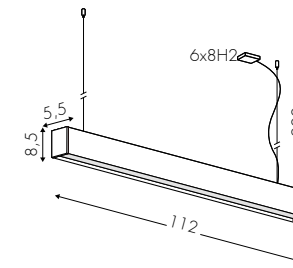

E2 Opale - Opal

B 3000K

BV



**1034BOFBVE2B**  
**1034BDMBVE2B**

35W 3010lm\* - 220V  
DALI (Push) - 35W 3010lm - 220V

**357,00 €**  
**413,00 €**

**1034COFBVE2B**  
**1034CDMBVE2B**

44W 3765lm - 220V  
DALI (Push) - 44W 3765lm - 220V

**389,00 €**  
**447,00 €**

**1034DOFBVE2B**  
**1034DDMBVE2B**

53W 4515lm - 220V  
DALI (Push) - 53W 4515lm - 220V

**434,00 €**  
**493,00 €**

**1034EOFBVE2B**  
**1034EDMBVE2B**

62W 5265lm - 220V  
DALI (Push) - 62W 5265lm - 220V

**461,00 €**  
**522,00 €**

**1034FOFBVE2B**  
**1034FDMBVE2B**

70W 6020lm - 220V  
DALI (Push) - 70W 6020lm - 220V

**517,00 €**  
**580,00 €**

**1034GOFBVE2B**  
**1034GDMBVE2B**

79W 6775lm - 220V  
DALI (Push) - 79W 6775lm - 220V

**569,00 €**  
**616,00 €**

**1034HOFBVE2B**  
**1034HDMBVE2B**

88W 7525lm - 220V  
DALI (Push) - 88W 7525lm - 220V

**623,00 €**  
**672,00 €**

Configura

Configure / Konfigurieren

[www.teamitaliailluminazione.it](http://www.teamitaliailluminazione.it)



E19 UGR<19 Prism

C 4000K

NE



**CODICE COMPLETO DEL PRODOTTO NELLA FOTO**  
FULL PRODUCT CODE AS SHOWN IN PICTURE - VOLLSTÄNDIGER CODE VOM ARTIKEL IM BILD

**1034COF**

**BV**

**E19**

**C**

Codice  
Code

Finitura  
Finishing  
Lackierung

Diffusore  
Diffuser  
Diffusor

Tonalità  
Hue  
Farbton

BV NE

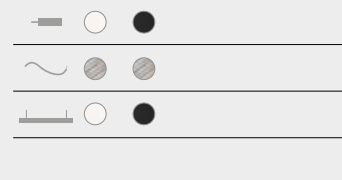

**A** Alimentatore Incorporato - Incorporated Power Supply - Eingebautes Netzteil

\* 3010lm effettivi - effective - effektive con - with - mit **E2**  
3540lm effettivi - effective - effektive con - with - mit **E19** **+17,5%**



configurazione standard: / basic configuration: / Standard Konfiguration:

E2 Opale - Opal

B 3000K

BV

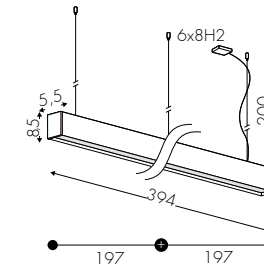

**1034LOFBVE2B**  
**1034LDMBVE2B**

123W 10530lm\* - 220V  
DALI (Push) - 123W 10530lm - 220V

**1.001,00 €**  
**1.150,00 €**

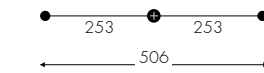

**1034MOFBVE2B**  
**1034MDMBVE2B**

158W 13550lm - 220V  
DALI (Push) - 158W 13550lm - 220V

**1.174,00 €**  
**1.291,00 €**

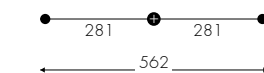

**1034NOFBVE2B**  
**1034NDMBVE2B**

176W 15050lm - 220V  
DALI (Push) - 176W 15050lm - 220V

**1.298,00 €**  
**1.419,00 €**

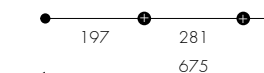

**1034OOFBVE2B**  
**1034ODMBVE2B**

212W 18060lm - 220V  
DALI (Push) - 212W 18060lm - 220V

**1.635,00 €**  
**1.853,00 €**



**1034POFBVE2B**  
**1034PDMBVE2B**

246W 21070lm - 220V  
DALI (Push) - 246W 21070lm - 220V

**1.923,00 €**  
**2.122,00 €**



**1034QOFBVE2B**  
**1034QDMBVE2B**

264W 22575lm - 220V  
DALI (Push) - 264W 22575lm - 220V

**2.059,00 €**  
**2.264,00 €**



**1034ROFBVE2B**  
**1034RDMBVE2B**

317W 27090lm - 220V  
DALI (Push) - 317W 27090lm - 220V

**2.593,00 €**  
**2.848,00 €**

Configura

Configure / Konfigurieren

[www.teamitaliailluminazione.it](http://www.teamitaliailluminazione.it)



E19 UGR<19 Prism

C 4000K

NE



**CODICE COMPLETO DEL PRODOTTO NELLA FOTO**  
FULL PRODUCT CODE AS SHOWN IN PICTURE - VOLLSTÄNDIGER CODE VOM ARTIKEL IM BILD

**1034POF** **NE** **E2** **B**

Codice  
Code

Finitura  
Finishing  
Lackierung

Diffusore  
Diffuser  
Diffusor

Tonalità  
Hue  
Farbton

BV



NE

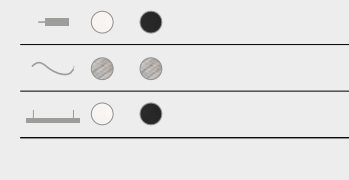

**A** Alimentatore Incorporato - Incorporated Power Supply - Eingebautes Netzteil

\* 10530lm effettivi - effective - effektive con - with - mit **E2**  
12390lm effettivi - effective - effektive con - with - mit **E19** **+17,5%**





# MIRÓ SPOTLIGHT

SOSPENSIONE  
SUSPENSION LAMP  
PENDELLEUCHE



configurazione standard: / basic configuration: / Standard Konfiguration:

24° Ottica - Optic - Optik ● B 3000K

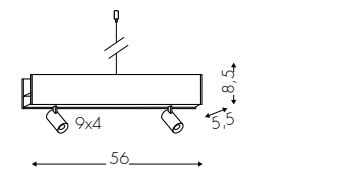

**1030S2OFBV24B** Spot 2x7W 2x680lm\* - 220V 399,00 €  
**1030S2DMBV24B** DALI (Push) - Spot 2x7W 2x680lm - 220V 506,00 €

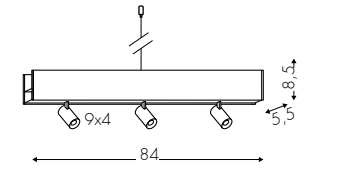

**1030S3OFBV24B** Spot 3x7W 3x680lm - 220V 515,00 €  
**1030S3DMBV24B** DALI (Push) - Spot 3x7W 3x680lm - 220V 633,00 €

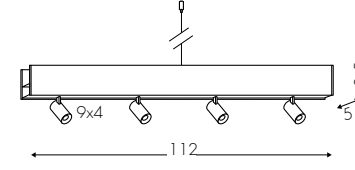

**1030S4OFBV24B** Spot 4x7W 4x680lm - 220V 608,00 €  
**1030S4DMBV24B** DALI (Push) - Spot 4x7W 4x680lm - 220V 726,00 €

Configura Configure / Konfigurieren

[www.teamitaliailluminazione.it](http://www.teamitaliailluminazione.it)

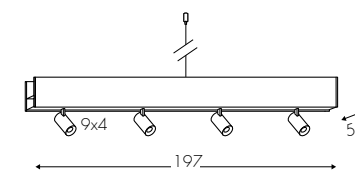

**1030S5OFBV24B** Spot 4x7W 4x680lm + 18W 2390lm - 220V 1.013,00 €  
**1030S5DMBV24B** DALI (Push) - Spot 4x7W 4x680lm + 18W 2390lm - 220V 1.118,00 €

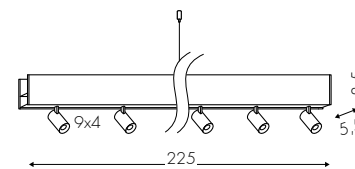

**1030S6OFBV24B** Spot 5x7W 5x680lm + 18W 2390lm - 220V 1.389,00 €  
**1030S6DMBV24B** DALI (Push) - Spot 5x7W 5x680lm + 18W 2390lm - 220V 1.550,00 €

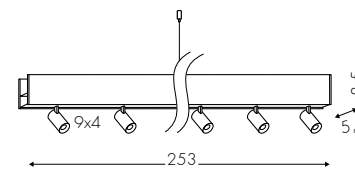

**1030S7OFBV24B** Spot 5x7W 5x680lm + 18W 2390lm - 220V 1.505,00 €  
**1030S7DMBV24B** DALI (Push) - Spot 5x7W 5x680lm + 18W 2390lm - 220V 1.669,00 €

Configura Configure / Konfigurieren

[www.teamitaliailluminazione.it](http://www.teamitaliailluminazione.it)



○ C 4000K



**CODICE COMPLETO DEL PRODOTTO NELLA FOTO**  
**FULL PRODUCT CODE AS SHOWN IN PICTURE - VOLLSTÄNDIGER CODE VOM ARTIKEL IM BILD**

**1030S7OF** **NE** **24** **B**

Codice  
Code

Finitura  
Finishing  
Lackierung

Diffusore  
Diffuser  
Diffusor

Tonalità  
Hue  
Farbton

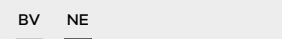

**A** Alimentatore Incorporato - Incorporated Power Supply - Eingebautes Netzteil

\* 2x680lm effettivi - effective - effektive con - with - mit 24°





configurazione standard: / basic configuration: / Standard Konfiguration:

BV

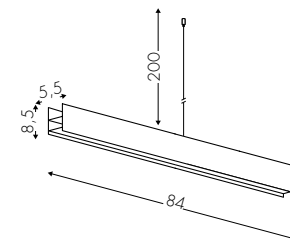

**1036AOFBV\***  
**1036ADMBV**

Modulo non luminoso - No light element - Pendelleuchte Blindabdeckung  
Modulo non luminoso - No light element - Pendelleuchte Blindabdeckung

**180,00 €**  
**191,00 €**

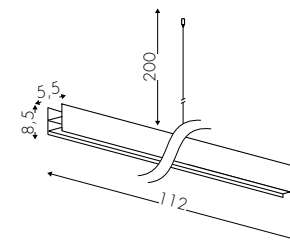

**1036BOFBV\***  
**1036BDMBV**

Modulo non luminoso - No light element - Pendelleuchte Blindabdeckung  
Modulo non luminoso - No light element - Pendelleuchte Blindabdeckung

**193,00 €**  
**212,00 €**

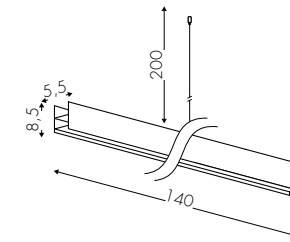

**1036COFBV\***  
**1036CDMBV**

Modulo non luminoso - No light element - Pendelleuchte Blindabdeckung  
Modulo non luminoso - No light element - Pendelleuchte Blindabdeckung

**209,00 €**  
**225,00 €**

Configura 

Configure / Konfigurieren

[www.teamitaliailluminazione.it](http://www.teamitaliailluminazione.it) 



BV  NE

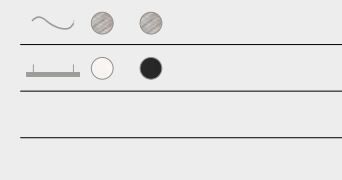

\* Compatibile con moduli TF - Compatible with TF module - Kompatibel mit Typ A Modul

 **CODICE COMPLETO DEL PRODOTTO NELLA FOTO**  
FULL PRODUCT CODE AS SHOWN IN PICTURE - VOLLSTÄNDIGER CODE VOM ARTIKEL IM BILD

**1036AOF** **NE**

Codice  
Code

Finitura  
Finishing  
Lackierung



configurazione standard: / basic configuration: / Standard Konfiguration:

E2 Opale - Opal

B 3000K

BV

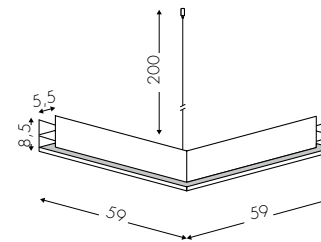

1030KGAOFBVE2B

35W 3029lm\* - 220V

454,00 €

1030KGADMBVE2B

DALI (Push) - 35W 3029lm - 220V

520,00 €

1030KATFBVE2B

35W 3029lm - 220V

520,00 €

Configura 

Configure / Konfigurieren

[www.teamitaliailluminazione.it](http://www.teamitaliailluminazione.it) 

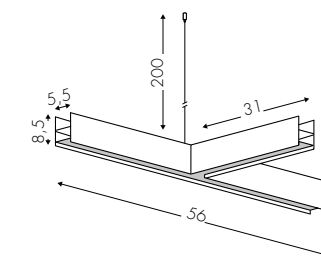

1030KGTOFBVE2B

26W 2277lm - 220V

563,00 €

1030KGTDMBVE2B

DALI (Push) - 26W 2277lm - 220V

634,00 €

1030KGTTFBVE2B

26W 2277lm - 220V

634,00 €

Configura 

Configure / Konfigurieren

[www.teamitaliailluminazione.it](http://www.teamitaliailluminazione.it) 

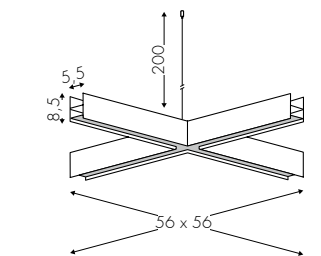

1030KGC OFBVE2B

35W 3029lm - 220V

741,00 €

1030KGC DMBVE2B

DALI (Push) - 35W 3029lm - 220V

817,00 €

1030KGC TFBVE2B

35W 3029lm - 220V

817,00 €

Configura 

Configure / Konfigurieren

[www.teamitaliailluminazione.it](http://www.teamitaliailluminazione.it) 



E19 UGR<19 Prism

C 4000K

NE



 CODICE COMPLETO DEL PRODOTTO NELLA FOTO  
FULL PRODUCT CODE AS SHOWN IN PICTURE - VOLLSTÄNDIGER CODE VOM ARTIKEL IM BILD

**1030KGAOF** **NE** **E19** **B**

Codice  
Code

Finitura  
Finishing  
Lackierung

Diffusore  
Diffuser  
Diffusor

Tonalità  
Hue  
Farbton

BV



NE



**TF** Taglio di Fase - Phase-Cut Dimmer - Erhältlich Phasenabschnittdimmer

**A** Alimentatore Incorporato - Incorporated Power Supply - Eingebautes Netzteil

\* 3029lm effettivi - effective - effektive con - with - mit **E2**  
3540lm effettivi - effective - effektive con - with - mit **E19**  +17,5%

configurazione standard: / basic configuration: / Standard Konfiguration:

BV

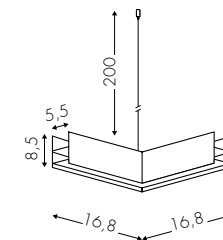

**1036KGAOFBV\***  
**1036KGADMBV**

Modulo non luminoso - No light element - Pendelleuchte Blindabdeckung  
Modulo non luminoso - No light element - Pendelleuchte Blindabdeckung

**253,00 €**  
**277,00 €**

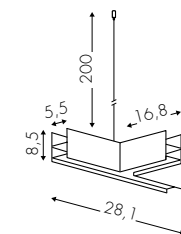

**1036KGTOFBV\***  
**1036KGTDMBV**

Modulo non luminoso - No light element - Pendelleuchte Blindabdeckung  
Modulo non luminoso - No light element - Pendelleuchte Blindabdeckung

**273,00 €**  
**297,00 €**

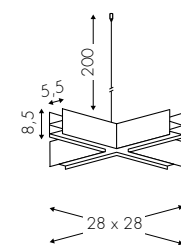

**1036KGC OFBV\***  
**1036KGC DMBV**

Modulo non luminoso - No light element - Pendelleuchte Blindabdeckung  
Modulo non luminoso - No light element - Pendelleuchte Blindabdeckung

**294,00 €**  
**319,00 €**

Configura 

Configure / Konfigurieren

[www.teamitaliailluminazione.it](http://www.teamitaliailluminazione.it) 

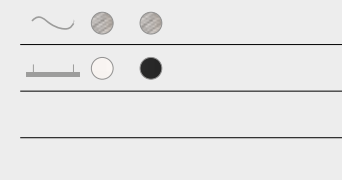

\* Compatibile con modulo **TF** - Compatible with **TF** module - Kompatibel mit **TF** Modul

 **CODICE COMPLETO DEL PRODOTTO NELLA FOTO**  
FULL PRODUCT CODE AS SHOWN IN PICTURE - VOLLSTÄNDIGER CODE VOM ARTIKEL IM BILD

**1036KGAOF** **NE**

Codice  
Code

Finitura  
Finishing  
Lackierung





configurazione standard: / basic configuration: / Standard Konfiguration:

24° Ottica - Optic - Optik ● B 3000K

BV

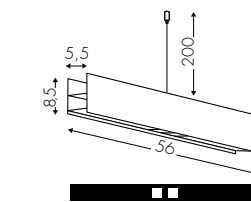

**1046ZOFBV24B**  
**1046ZDMBV24B**

9W 900lm\* - 220V  
DALI (Push) - 9W 900lm - 220V

**423,00 €**  
**531,00 €**

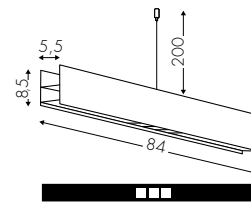

**1046AOFBV24B**  
**1046ADMV24B**

13W 1500lm - 220V  
DALI (Push) - 13W 1500lm - 220V

**538,00 €**  
**656,00 €**

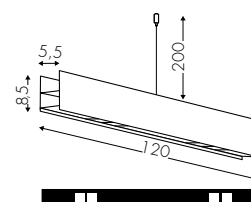

**1046BOFBV24B**  
**1046BDMV24B**

2x9W 2x900lm - 220V  
DALI (Push) - 2x9W 2x900lm - 220V

**643,00 €**  
**763,00 €**

Configura  Configure / Konfigurieren

[www.teamitaliailluminazione.it](http://www.teamitaliailluminazione.it) 



NE

**CODICE COMPLETO DEL PRODOTTO NELLA FOTO**  
FULL PRODUCT CODE AS SHOWN IN PICTURE - VOLLSTÄNDIGER CODE VOM ARTIKEL IM BILD

**1046BOF** **BV** **24** **B**

Codice  
Code

Finitura  
Finishing  
Lackierung

Diffusore  
Diffuser  
Diffusor

Tonalità  
Hue  
Farbton

**A** Alimentatore Incorporato - Incorporated Power Supply - Eingebautes Netzteil

\* 900lm effettivi - effective - effektive con - with - mit 24°

# EMME 24 DOWNLIGHT (1-3mt)

PLAFONE  
CEILING LIGHT  
DECKENLEUCHTE

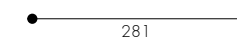
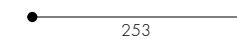
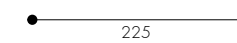
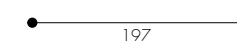
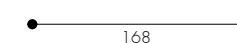
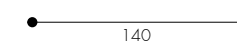
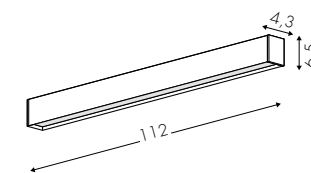

configurazione standard: / basic configuration: / Standard Konfiguration:

E2 Opale - Opal

B 3000K

BV

**3037BBVE2B** 25W 1910lm\* - 24VDC **285,00 €**

**3037CBVE2B** 31W 2385lm - 24VDC **301,00 €**

**3037DBVE2B** 37W 2860lm - 24VDC **322,00 €**

**3037EBVE2B** 44W 3350lm - 24VDC **340,00 €**

**3037FBVE2B** 50W 3830lm - 24VDC **370,00 €**

**3037GBVE2B** 56W 4305lm - 24VDC **394,00 €**

**3037HBVE2B** 62W 4780lm - 24VDC **421,00 €**

Configura

Configure / Konfigurieren

[www.teamitaliailluminazione.it](http://www.teamitaliailluminazione.it)



E19 UGR<19 Prism

C 4000K

NE

**CODICE COMPLETO DEL PRODOTTO NELLA FOTO**  
FULL PRODUCT CODE AS SHOWN IN PICTURE - VOLLSTÄNDIGER CODE VOM ARTIKEL IM BILD

**3037D**

Codice  
Code

**NE**

Finitura  
Finishing  
Lackierung

**E19**

Diffusore  
Diffuser  
Diffusor

**B**

Tonalità  
Hue  
Farbton

Alimentatore non incluso - Power Supply not included - Netzteil nicht inbegriffen  
**Alimentatori a pag. 564-565 - Drivers p. 564-565 - Netzteil p. 564-565**

\* 1910lm effettivi - effective - effektive con - with - mit **E2**  
2240lm effettivi - effective - effektive con - with - mit **E19** **+17,5%**

INDEX

SECTION

FAMILY 453

# EMME 24 DOWNLIGHT (3-10mt)

PLAFONE  
CEILING LIGHT  
DECKENLEUCHTE



configurazione standard: / basic configuration: / Standard Konfiguration:

E2 Opale - Opal

● B 3000K

BV

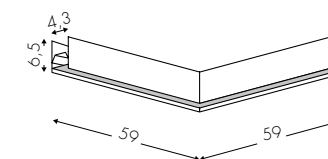
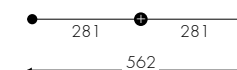
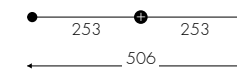
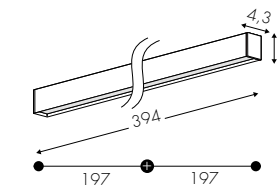

3037LBVE2B

87W 6705lm\* - 24VDC

743,00 €

3037MBVE2B

111W 8605lm - 24VDC

784,00 €

3037NBVE2B

124W 9560lm - 24VDC

896,00 €

3037OBVE2B

148,5W 11485lm - 24VDC

1.179,00 €

3037PBVE2B

173W 13380lm - 24VDC

1.310,00 €

3037QBVE2B

185W 14340lm - 24VDC

1.345,00 €

3037RBVE2B

223W 17210lm - 24VDC

1.774,00 €

Configura

Configure / Konfigurieren

[www.teamitaliailluminazione.it](http://www.teamitaliailluminazione.it)

3037KGA

25W 1905lm - 24VDC

352,00 €

Configura

Configure / Konfigurieren

[www.teamitaliailluminazione.it](http://www.teamitaliailluminazione.it)

E19 UGR<19 Prism

○ C 4000K

NE

CODICE COMPLETO DEL PRODOTTO NELLA FOTO  
FULL PRODUCT CODE AS SHOWN IN PICTURE - VOLLSTÄNDIGER CODE VOM ARTIKEL IM BILD

**3037L**

Codice  
Code

**NE**

Finitura  
Finishing  
Lackierung

**E2**

Diffusore  
Diffuser  
Diffusor

**B**

Tonalità  
Hue  
Farbton

Alimentatore non incluso - Power Supply not included - Netzteil nicht inbegriffen  
**Alimentatori a pag. 564-565 - Drivers p. 564-565 - Netzteil p. 564-565**

\* 6705lm effettivi - effective - effektive con - with - mit **E2**  
7880lm effettivi - effective - effektive con - with - mit **E19** +17,5%

INDEX

SECTION

FAMILY 455



configurazione standard: / basic configuration: / Standard Konfiguration:

E2 Opale - Opal ● B 3000K

BV

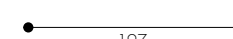
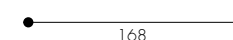
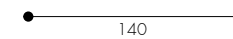
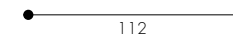
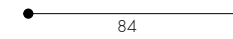
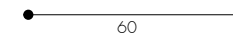
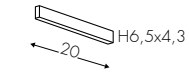

<b>3058TOFBVE2B</b>	7,5W 850lm* - 220V	<b>136,00 €</b>
<b>3058TTFBVE2B</b>	7,5W 850lm - 220V	<b>162,00 €</b>
<b>3058UOFBVE2B</b>	9W 1010lm - 220V	<b>236,00 €</b>
<b>3058UTFBVE2B</b>	9W 1010lm - 220V	<b>265,00 €</b>
<b>3058AOFBVE2B</b>	13,5W 1520lm - 220V	<b>329,00 €</b>
<b>3058ADMBVE2B</b>	DALI (Push) - 13,5W 1520lm - 220V	<b>374,00 €</b>
<b>3058BOFBVE2B</b>	18W 2025lm - 220V	<b>336,00 €</b>
<b>3058BDMBVE2B</b>	DALI (Push) - 18W 2025lm - 220V	<b>391,00 €</b>
<b>3058COFBVE2B</b>	22W 2530lm - 220V	<b>379,00 €</b>
<b>3058CDMBVE2B</b>	DALI (Push) - 22W 2530lm - 220V	<b>435,00 €</b>
<b>3058DOFBVE2B</b>	27W 3040lm - 220V	<b>395,00 €</b>
<b>3058DDMBVE2B</b>	DALI (Push) - 27W 3040lm - 220V	<b>464,00 €</b>
<b>3058EOFBVE2B</b>	31W 3540lm - 220V	<b>411,00 €</b>
<b>3058EDMBVE2B</b>	DALI (Push) - 31W 3540lm - 220V	<b>469,00 €</b>
<b>3058FOFBVE2B</b>	36W 4010lm - 220V	<b>411,00 €</b>
<b>3058FDMBVE2B</b>	DALI (Push) - 36W 4010lm - 220V	<b>469,00 €</b>
<b>3058GOFBVE2B</b>	39W 4510lm - 220V	<b>566,00 €</b>
<b>3058GDMBVE2B</b>	DALI (Push) - 39W 4510lm - 220V	<b>641,00 €</b>
<b>3058HOFBVE2B</b>	45W 5080lm - 220V	<b>613,00 €</b>
<b>3058HDMBVE2B</b>	DALI (Push) - 45W 5080lm - 220V	<b>660,00 €</b>

Configura  Configure / Konfigurieren

[www.teamitaliailluminazione.it](http://www.teamitaliailluminazione.it) 



E19 UGR<19 Prism ● A 2700K ○ C 4000K

NE RU 

**TF** Taglio di Fase - Phase-Cut Dimmer - Erhältlich Phasenabschnittdimmer

**A** Alimentatore Incorporato - Incorporated Power Supply - Eingebautes Netzteil

\* 850lm effettivi - effective - effektive con - with - mit **E2**  
1000lm effettivi - effective - effektive con - with - mit **E19** ↻ +17,5%



# M-ECO

DOWNLIGHT (3-10mt)

PLAFONE  
CEILING LIGHT  
DECKENLEUCHTE

configurazione standard: / basic configuration: / Standard Konfiguration:

E2 Opale - Opal

B 3000K

BV

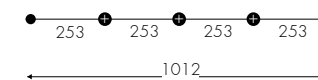
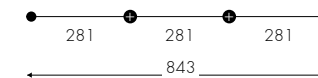
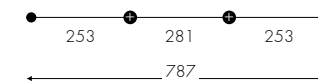
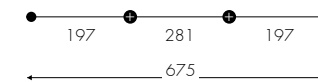
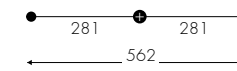
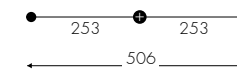
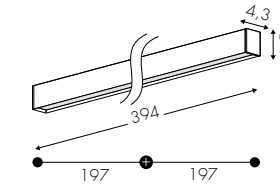

<b>3058LOFBVE2B</b>	62W 7080lm* - 220V	<b>822,00</b> €
<b>3058LDMBVE2B</b>	DALI (Push) - 62W 7080lm - 220V	<b>937,00</b> €
<b>3058MOFBVE2B</b>	78W 9010lm - 220V	<b>1.132,00</b> €
<b>3058MDMBVE2B</b>	DALI (Push) - 78W 9010lm - 220V	<b>1.281,00</b> €
<b>3058NOFBVE2B</b>	90W 10155lm - 220V	<b>1.225,00</b> €
<b>3058NDMBVE2B</b>	DALI (Push) - 90W 10155lm - 220V	<b>1.320,00</b> €
<b>3058OOFBVE2B</b>	107W 12160lm - 220V	<b>1.435,00</b> €
<b>3058ODMBVE2B</b>	DALI (Push) - 107W 12160lm - 220V	<b>1.597,00</b> €
<b>3058POFBVE2B</b>	123W 14095lm - 220V	<b>1.744,00</b> €
<b>3058PDMBVE2B</b>	DALI (Push) - 123W 14095lm - 220V	<b>1.941,00</b> €
<b>3058QOFBVE2B</b>	135W 15230lm - 220V	<b>1.838,80</b> €
<b>3058QDMBVE2B</b>	DALI (Push) - 135W 15230lm - 220V	<b>1.979,00</b> €
<b>3058ROFBVE2B</b>	156W 18030lm - 220V	<b>2.195,00</b> €
<b>3058RDMBVE2B</b>	DALI (Push) - 156W 18030lm - 220V	<b>2.561,00</b> €

Configura

Configure / Konfigurieren

[www.teamitaliailluminazione.it](http://www.teamitaliailluminazione.it)



E19 UGR<19 Prism

A 2700K  C 4000K

NE RU



**A** Alimentatore Incorporato - Incorporated Power Supply - Eingebautes Netzteil

\* 7080lm effettivi - effective - effektive con - with - mit **E2**  
8330lm effettivi - effective - effektive con - with - mit **E19** +17,5%

**CODICE COMPLETO DEL PRODOTTO NELLA FOTO**  
FULL PRODUCT CODE AS SHOWN IN PICTURE - VOLLSTÄNDIGER CODE VOM ARTIKEL IM BILD

**3058LOF** **NE** **E2** **B**

Codice  
Code

Finitura  
Finishing  
Lackierung

Diffusore  
Diffuser  
Diffusor

Tonalità  
Hue  
Farbton

INDEX

SECTION

FAMILY 459





configurazione standard: / basic configuration: / Standard Konfiguration:

E2 Opale - Opal

● B 3000K

BV

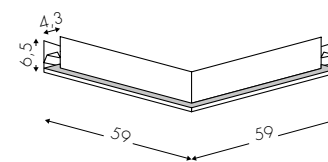

**3058KGAOFBVE2B**

18W 2025lm\* - 220V

**430,00 €**

**3058KGADMBVE2B**

DALI (Push) - 18W 2025lm - 220V

**495,00 €**

Configura

Configure / Konfigurieren

[www.teamitaliailluminazione.it](http://www.teamitaliailluminazione.it)

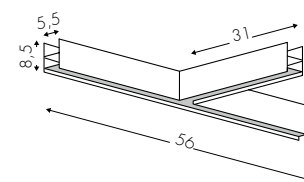

**3058KGTFOBVE2B**

14W 1575lm - 220V

**535,00 €**

**3058KGTDMBVE2B**

DALI (Push) - 14W 1575lm - 220V

**602,00 €**

Configura

Configure / Konfigurieren

[www.teamitaliailluminazione.it](http://www.teamitaliailluminazione.it)

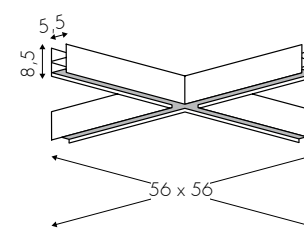

**3058KGCFOBVE2B**

18W 2025lm - 220V

**705,00 €**

**3058KGCDBVE2B**

DALI (Push) - 18W 2025lm - 220V

**775,00 €**

Configura

Configure / Konfigurieren

[www.teamitaliailluminazione.it](http://www.teamitaliailluminazione.it)



E19 UGR<19 Prism

● A 2700K ○ C 4000K

NE RU



A Alimentatore Incorporato - Incorporated Power Supply - Eingebautes Netzteil

\* 2025lm effettivi - effective - effektive con - with - mit **E2**  
2380lm effettivi - effective - effektive con - with - mit **E19** ↻ +17,5%

**CODICE COMPLETO DEL PRODOTTO NELLA FOTO**  
FULL PRODUCT CODE AS SHOWN IN PICTURE - VOLLSTÄNDIGER CODE VOM ARTIKEL IM BILD

**3058KGAOF** **BV** **E2** **B**

Codice  
Code

Finitura  
Finishing  
Lackierung

Diffusore  
Diffuser  
Diffusor

Tonalità  
Hue  
Farbton





**Downlight**

<b>84cm</b>	<b>112cm</b>	<b>140cm</b>	<b>168cm</b>	<b>197cm</b>	<b>225cm</b>	<b>253cm</b>	<b>281cm</b>
3030A	3030B	3030C	3030D	3030E	3030F	3030G	3030H
<b>394cm</b>	<b>506cm</b>	<b>562cm</b>	<b>675cm</b>	<b>787cm</b>	<b>843cm</b>	<b>1012cm</b>	
3030L	3030M	3030N	3030O	3030P	3030Q	3030R	



**Spotlight**

<b>56cm</b>	<b>84cm</b>	<b>112cm</b>	<b>197cm</b>	<b>225cm</b>	<b>253cm</b>
3030S2	3030S3	3030S4	3030S5	3030S6	3030S7



**Geometrical element downlight**

<b>59*59cm</b>	<b>56*31cm</b>	<b>56*56cm</b>
3030KGA	3030KGT	3030KGC



**Darklight**

<b>56cm</b>	<b>84cm</b>	<b>120cm</b>
3046Z	3046A	3046B



**No-light**

<b>84cm</b>	<b>112cm</b>	<b>140cm</b>
3036A	3036B	3036C



**Geometrical element No-light**

<b>17x17cm</b>	<b>28x17cm</b>	<b>28x28cm</b>
3036KGA	3036KGT	3036KGC

OF	DM
BV	NE
E2	E19
24°	
● B 3000K	
○ C 4000K	

OF	DM
BV	NE
24°	
● B 3000K	

OF	DM
BV	NE

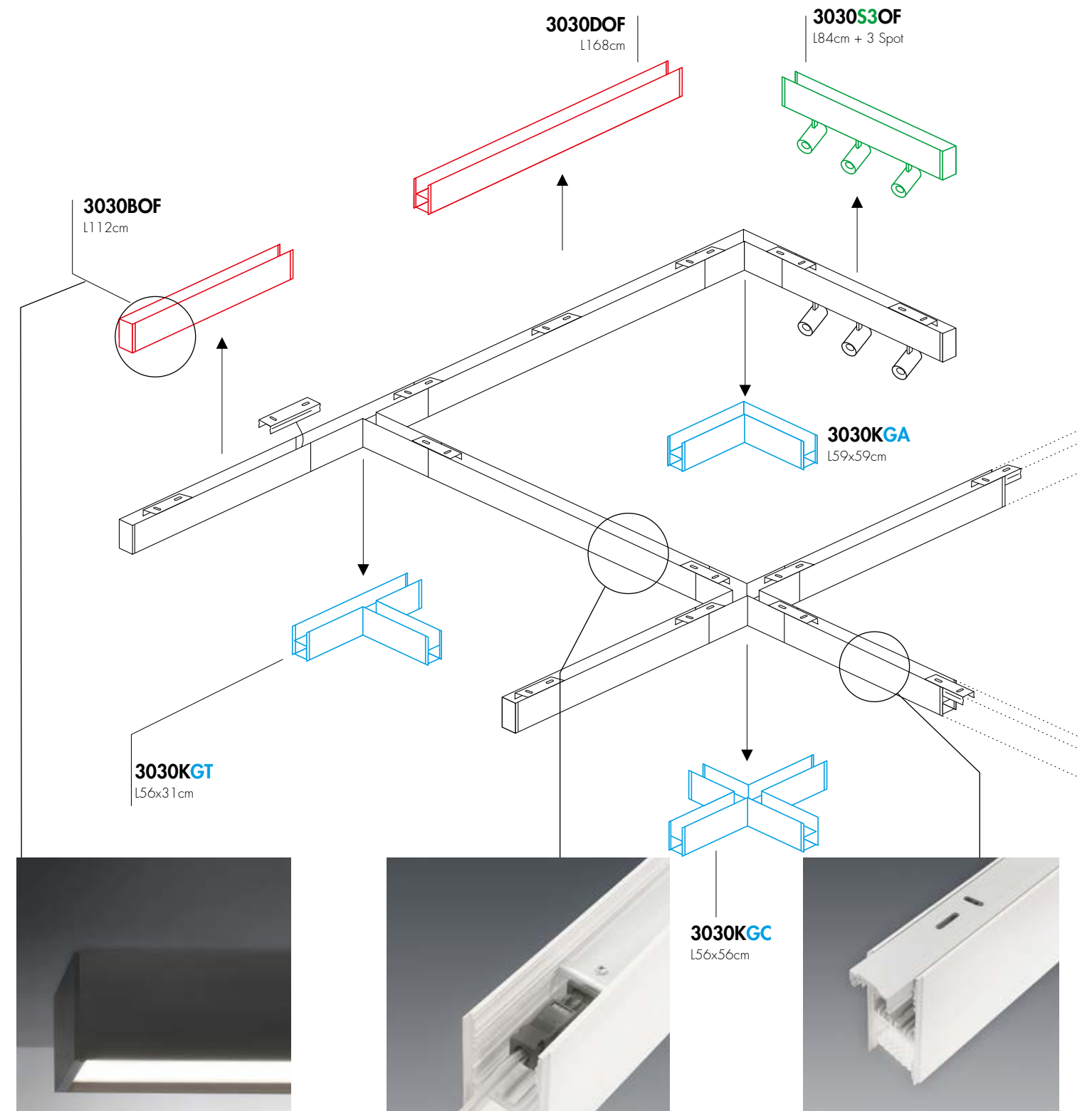



configurazione standard: / basic configuration: / Standard Konfiguration:

E2 Opale - Opal

● B 3000K

BV

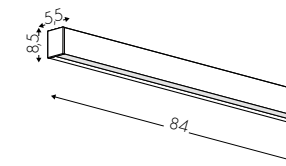

112

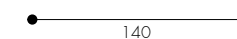

140

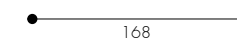

168

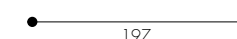

197

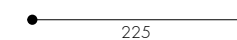

225

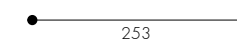

253

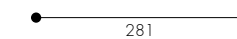

281

<b>3030AOFBVE2B</b>	26W 2260lm* - 220V	<b>347,00 €</b>
<b>3030ADMBVE2B</b>	DALI (Push) - 26W 2260lm - 220V	<b>394,00 €</b>
<b>3030ATFBVE2B</b>	26W 2260lm - 220V	<b>394,00 €</b>
<b>3030BOFBVE2B</b>	35W 3010lm - 220V	<b>355,00 €</b>
<b>3030BDMBVE2B</b>	DALI (Push) - 35W 3010lm - 220V	<b>410,00 €</b>
<b>3030BTFBVE2B</b>	35W 3010lm - 220V	<b>410,00 €</b>
<b>3030COFBVE2B</b>	44W 3765lm - 220V	<b>383,00 €</b>
<b>3030CDMBVE2B</b>	DALI (Push) - 44W 3765lm - 220V	<b>440,00 €</b>
<b>3030CTFBVE2B</b>	44W 3765lm - 220V	<b>440,00 €</b>
<b>3030DOFBVE2B</b>	53W 4515lm - 220V	<b>430,00 €</b>
<b>3030DDMBVE2B</b>	DALI (Push) - 53W 4515lm - 220V	<b>488,00 €</b>
<b>3030DTFBVE2B</b>	53W 4515lm - 220V	<b>488,00 €</b>
<b>3030EOFBVE2B</b>	62W 5265lm - 220V	<b>482,00 €</b>
<b>3030EDMBVE2B</b>	DALI (Push) - 62W 5265lm - 220V	<b>542,00 €</b>
<b>3030ETFBVE2B</b>	62W 5265lm - 220V	<b>542,00 €</b>
<b>3030FOFBVE2B</b>	70W 6020lm - 220V	<b>535,00 €</b>
<b>3030FDMBVE2B</b>	DALI (Push) - 70W 6020lm - 220V	<b>597,00 €</b>
<b>3030FTFBVE2B</b>	70W 6020lm - 220V	<b>597,00 €</b>
<b>3030GOFBVE2B</b>	79W 6775lm - 220V	<b>589,00 €</b>
<b>3030GDMBVE2B</b>	DALI (Push) - 79W 6775lm - 220V	<b>636,00 €</b>
<b>3030GTFBVE2B</b>	79W 6775lm - 220V	<b>636,00 €</b>
<b>3030HOFBVE2B</b>	88W 7525lm - 220V	<b>645,00 €</b>
<b>3030HDMBVE2B</b>	DALI (Push) - 88W 7525lm - 220V	<b>695,00 €</b>
<b>3030HTFBVE2B</b>	88W 7525lm - 220V	<b>695,00 €</b>

Configura 

Configure / Konfigurieren

[www.teamitaliailluminazione.it](http://www.teamitaliailluminazione.it)



E19 UGR<19 Prism

C 4000K

NE



**CODICE COMPLETO DEL PRODOTTO NELLA FOTO**  
FULL PRODUCT CODE AS SHOWN IN PICTURE - VOLLSTÄNDIGER CODE VOM ARTIKEL IM BILD

**3030GOF** **NE** **E19** **B**

Codice  
Code

Finitura  
Finishing  
Lackierung

Diffusore  
Diffuser  
Diffusor

Tonalità  
Hue  
Farbton

**TF** Taglio di Fase - Phase-Cut Dimmer - Erhältlich Phasenabschnittdimmer

**A** Alimentatore Incorporato - Incorporated Power Supply - Eingebautes Netzteil

\* 2260lm effettivi - effective - effektive con - with - mit **E2**  
2655lm effettivi - effective - effektive con - with - mit **E19** ↻ +17,5%

configurazione standard: / basic configuration: / Standard Konfiguration:

E2 Opale - Opal

● B 3000K

BV

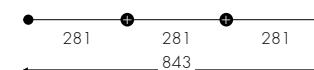
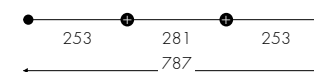
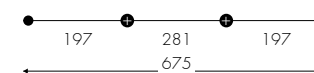
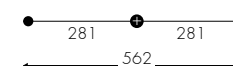
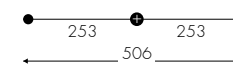
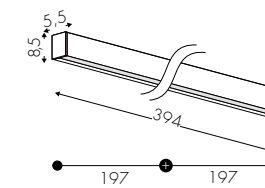

<b>3030LOFBVE2B</b>	123W 10530lm* - 220V	<b>1.059,00</b> €
<b>3030LDMBVE2B</b>	DALI (Push) - 123W 10530lm - 220V	<b>1.209,00</b> €
<b>3030LTFBVE2B</b>	123W 10530lm - 220V	<b>1.209,00</b> €
<b>3030MOFBVE2B</b>	158W 13550lm - 220V	<b>1.224,00</b> €
<b>3030MDMBVE2B</b>	DALI (Push) - 158W 13550lm - 220V	<b>1.342,00</b> €
<b>3030MTFBVE2B</b>	158W 13550lm - 220V	<b>1.342,00</b> €
<b>3030NOFBVE2B</b>	176W 15050lm - 220V	<b>1.343,00</b> €
<b>3030NDMBVE2B</b>	DALI (Push) - 176W 15050lm - 220V	<b>1.575,00</b> €
<b>3030NTFBVE2B</b>	176W 15050lm - 220V	<b>1.575,00</b> €
<b>3030OOFBVE2B</b>	212W 18060lm - 220V	<b>1.753,00</b> €
<b>3030ODMBVE2B</b>	DALI (Push) - 212W 18060lm - 220V	<b>1.975,00</b> €
<b>3030OTFBVE2B</b>	212W 18060lm - 220V	<b>1.975,00</b> €
<b>3030POFBVE2B</b>	246W 21070lm - 220V	<b>2.035,00</b> €
<b>3030PDMBVE2B</b>	DALI (Push) - 246W 21070lm - 220V	<b>2.238,00</b> €
<b>3030PTFBVE2B</b>	246W 21070lm - 220V	<b>2.238,00</b> €
<b>3030QOFBVE2B</b>	264W 22575lm - 220V	<b>2.178,00</b> €
<b>3030QDMBVE2B</b>	DALI (Push) - 264W 22575lm - 220V	<b>2.513,00</b> €
<b>3030QTFBVE2B</b>	264W 22575lm - 220V	<b>2.513,00</b> €
<b>3030ROFBVE2B</b>	317W 27090lm - 220V	<b>2.607,00</b> €
<b>3030RDMBVE2B</b>	DALI (Push) - 317W 27090lm - 220V	<b>2.943,00</b> €
<b>3030RTFBVE2B</b>	317W 27090lm - 220V	<b>2.943,00</b> €

Configura 

Configure / Konfigurieren

[www.teamitaliailluminazione.it](http://www.teamitaliailluminazione.it) 



E19 UGR<19 Prism

C 4000K

NE

 **CODICE COMPLETO DEL PRODOTTO NELLA FOTO**  
FULL PRODUCT CODE AS SHOWN IN PICTURE - VOLLSTÄNDIGER CODE VOM ARTIKEL IM BILD

**3030LOF** **NE** **E2** **B**

Codice  
Code

Finitura  
Finishing  
Lackierung

Diffusore  
Diffuser  
Diffusor

Tonalità  
Hue  
Farbton

**TF** Taglio di Fase - Phase-Cut Dimmer - Erhältlich Phasenabschnittdimmer

**A** Alimentatore Incorporato - Incorporated Power Supply - Eingebautes Netzteil

\* 10530lm effettivi - effective - effektive con - with - mit **E2**  
12390lm effettivi - effective - effektive con - with - mit **E19**  **+17,5%**





configurazione standard: / basic configuration: / Standard Konfiguration:

BV

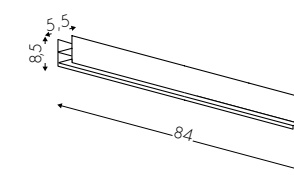

**3036AOFBV\***  
**3036ADMBV**

Modulo non luminoso - No light element - Deckenleuchte Blindabdeckung  
Modulo non luminoso - No light element - Deckenleuchte Blindabdeckung

**185,00 €**  
**197,00 €**

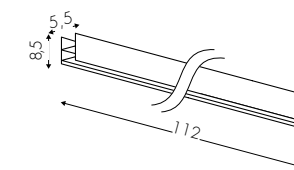

**3036BOFBV\***  
**3036BDMBV**

Modulo non luminoso - No light element - Deckenleuchte Blindabdeckung  
Modulo non luminoso - No light element - Deckenleuchte Blindabdeckung

**199,00 €**  
**218,00 €**

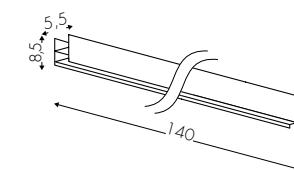

**3036COFBV\***  
**3036CDMBV**

Modulo non luminoso - No light element - Deckenleuchte Blindabdeckung  
Modulo non luminoso - No light element - Deckenleuchte Blindabdeckung

**215,00 €**  
**232,00 €**

Configura 

Configure / Konfigurieren

[www.teamitaliailluminazione.it](http://www.teamitaliailluminazione.it) 



NE

 **CODICE COMPLETO DEL PRODOTTO NELLA FOTO**  
FULL PRODUCT CODE AS SHOWN IN PICTURE - VOLLSTÄNDIGER CODE VOM ARTIKEL IM BILD

**3036COF** **NE**

Codice  
Code

Finitura  
Finishing  
Lackierung

\* Compatibile con moduli **TF** - Compatible with **TF** module - Kompatibel mit Typ A Modul

configurazione standard: / basic configuration: / Standard Konfiguration:

24° Ottica - Optic - Optik ● B 3000K

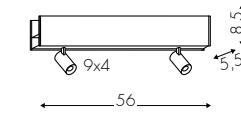

**3030S2OFBV24B**  
**3030S2DMBV24B**

Spot 2x7W 2x680lm\* - 220V  
DALI (Push) - Spot 2x7W 2x680lm - 220V

**399,00 €**  
**506,00 €**

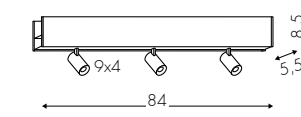

**3030S3OFBV24B**  
**3030S3DMBV24B**

Spot 3x7W 3x680lm - 220V  
DALI (Push) - Spot 3x7W 3x680lm - 220V

**515,00 €**  
**633,00 €**

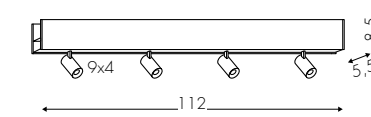

**3030S4OFBV24B**  
**3030S4DMBV24B**

Spot 4x7W 4x680lm - 220V  
DALI (Push) - Spot 4x7W 4x680lm - 220V

**608,00 €**  
**726,00 €**

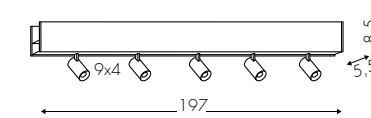

**3030S5OFBV24B**  
**3030S5DMBV24B**

Spot 5x7W 5x680lm - 220V  
DALI (Push) - Spot 5x7W 5x680lm - 220V

**900,00 €**  
**1.000,00 €**

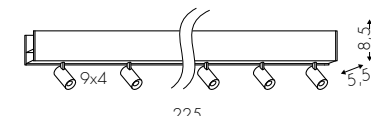

**3030S6OFBV24B**  
**3030S6DMBV24B**

Spot 5x7W 5x680lm - 220V  
DALI (Push) - Spot 5x7W 5x680lm - 220V

**1.273,00 €**  
**1.431,00 €**

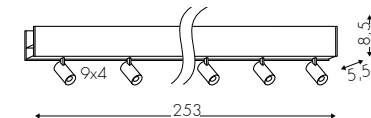

**3030S7OFBV24B**  
**3030S7DMBV24B**

Spot 5x7W 5x680lm - 220V  
DALI (Push) - Spot 5x7W 5x680lm - 220V

**1.389,00 €**  
**1.550,00 €**

Configura

Configure / Konfigurieren

[www.teamitaliailluminazione.it](http://www.teamitaliailluminazione.it)



○ C 4000K



A Alimentatore Incorporato - Incorporated Power Supply - Eingebautes Netzteil

\* 2x680lm effettivi - effective - effektive con - with - mit 24°



**CODICE COMPLETO DEL PRODOTTO NELLA FOTO**  
FULL PRODUCT CODE AS SHOWN IN PICTURE - VOLLSTÄNDIGER CODE VOM ARTIKEL IM BILD

**3030S2OF** **NE** **24** **B**

Codice Code	Finitura Finishing Lackierung	Diffusore Diffuser Diffusor	Tonalità Hue Farbton
----------------	-------------------------------------	-----------------------------------	----------------------------



configurazione standard: / basic configuration: / Standard Konfiguration:

E2 Opale - Opal

● B 3000K

BV

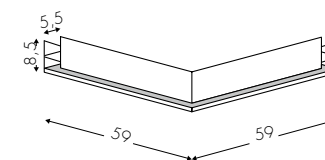

**3030KGAOFBVE2B**

35W 3010lm\* - 220V

**454,00 €**

**3030KADMBVE2B**

DALI (Push) - 35W 3010lm - 220V

**520,00 €**

**3030KATFBVE2B**

35W 3010lm - 220V

**520,00 €**

Configura

Configure / Konfigurieren

[www.teamitaliailluminazione.it](http://www.teamitaliailluminazione.it)

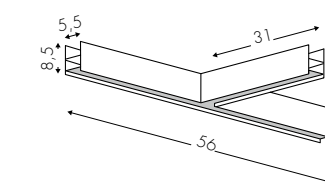

**3030KGTDFBVE2B**

26W 2250lm - 220V

**563,00 €**

**3030KGTDMBVE2B**

DALI (Push) - 26W 2250lm - 220V

**634,00 €**

**3030KGTTFBVE2B**

26W 2250lm - 220V

**634,00 €**

Configura

Configure / Konfigurieren

[www.teamitaliailluminazione.it](http://www.teamitaliailluminazione.it)

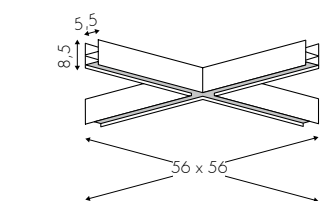

**3030KGCDFBVE2B**

35W 3010lm - 220V

**741,00 €**

**3030KGCDFBVE2B**

DALI (Push) - 35W 3010lm - 220V

**817,00 €**

**3030KGCTFBVE2B**

35W 3010lm - 220V

**817,00 €**

Configura

Configure / Konfigurieren

[www.teamitaliailluminazione.it](http://www.teamitaliailluminazione.it)



E19 UGR<19 Prism

C 4000K

NE



**CODICE COMPLETO DEL PRODOTTO NELLA FOTO**  
FULL PRODUCT CODE AS SHOWN IN PICTURE - VOLLSTÄNDIGER CODE VOM ARTIKEL IM BILD

**3030KGAOF** **NE** **E2** **B**

Codice  
Code

Finitura  
Finishing  
Lackierung

Diffusore  
Diffuser  
Diffusor

Tonalità  
Hue  
Farbton

**TF** Taglio di Fase - Phase-Cut Dimmer - Erhältlich Phasenabschrittdimmer

**A** Alimentatore Incorporato - Incorporated Power Supply - Eingebautes Netzteil

\* 3010lm effettivi - effective - effektive con - with - mit **E2**  
3540lm effettivi - effective - effektive con - with - mit **E19** ↻ +17,5%





configurazione standard: / basic configuration: / Standard Konfiguration:

BV

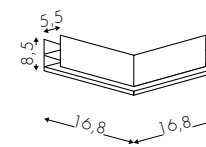

**3036KGAOFBV\***  
**3036KGADMBV**

Modulo non luminoso - No light element - No licht element  
Modulo non luminoso - No light element - No licht element

**260,00 €**  
**285,00 €**

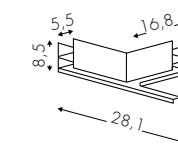

**3036KGT OFBV\***  
**3036KGTDMBV**

Modulo non luminoso - No light element - No licht element  
Modulo non luminoso - No light element - No licht element

**282,00 €**  
**306,00 €**

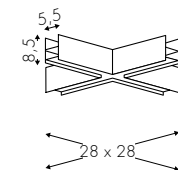

**3036KGC OFBV\***  
**3036KGCDBV**

Modulo non luminoso - No light element - No licht element  
Modulo non luminoso - No light element - No licht element

**303,00 €**  
**328,00 €**

Configura 

Configure / Konfigurieren

[www.teamitaliailluminazione.it](http://www.teamitaliailluminazione.it)



NE



 **CODICE COMPLETO DEL PRODOTTO NELLA FOTO**  
FULL PRODUCT CODE AS SHOWN IN PICTURE - VOLLSTÄNDIGER CODE VOM ARTIKEL IM BILD

**3036KGT OF** **NE**

Codice  
Code

Finitura  
Finishing  
Lackierung



configurazione standard: / basic configuration: / Standard Konfiguration:

24° Ottica - Optic - Optik ● B 3000K

BV

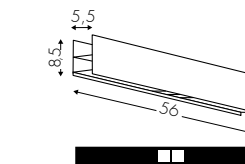

**3046ZOFBV24B**  
**3046ZDMBV24B**

9W 900lm\* - 220V  
DALI (Push) - 9W 900lm - 220V

**415,00 €**  
**521,00 €**

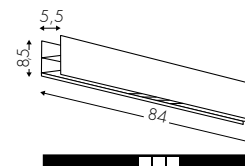

**3046AOFBV24B**  
**3046ADMBV24B**

13W 1500lm - 220V  
DALI (Push) - 13W 1500lm - 220V

**528,00 €**  
**644,00 €**

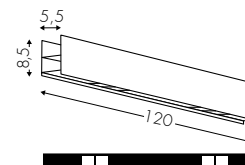

**3046BOFBV24B**  
**3046BDMBV24B**

2x9W 2x900lm - 220V  
DALI (Push) - 2x9W 2x900lm - 220V

**631,00 €**  
**749,00 €**

Configura  Configure / Konfigurieren

[www.teamitaliailluminazione.it](http://www.teamitaliailluminazione.it) 



NE

**A** Alimentatore Incorporato - Incorporated Power Supply - Eingebautes Netzteil

\* 900lm effettivi - effective - effektive con - with - mit 24°

**↑** CODICE COMPLETO DEL PRODOTTO NELLA FOTO  
FULL PRODUCT CODE AS SHOWN IN PICTURE - VOLLSTÄNDIGER CODE VOM ARTIKEL IM BILD

**3046BOF** **NE** **24** **B**

Codice Code	Finitura Finishing Lackierung	Diffusore Diffuser Diffusor	Tonalità Hue Farbton
----------------	-------------------------------------	-----------------------------------	----------------------------

# MIRÓ APPLIQUE

UPLIGHT - DOWNLIGHT

PARETE  
WALL LIGHT  
WANDLEUCHE



configurazione standard: / basic configuration: / Standard Konfiguration:

E2 Opale - Opal

B 3000K

BV

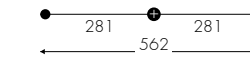
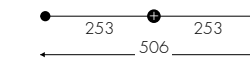
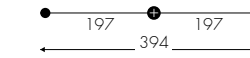
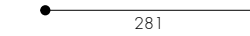
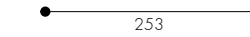
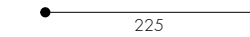
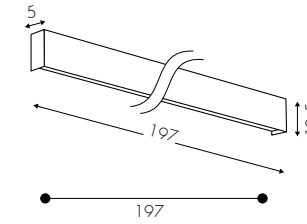

<b>2030EOFBVE2B</b>	44W 4570lm* + 44W 4570lm - 220V	<b>680,00 €</b>
<b>2030EDMBVE2B</b>	DALI(Push) 44W 4570lm + 44W 4570lm - 220V	<b>780,00 €</b>
<b>2030FOFBVE2B</b>	50W 5200lm + 50W 5200lm - 220V	<b>752,00 €</b>
<b>2030FDMBVE2B</b>	DALI(Push) 50W 5200lm + 50W 5200lm - 220V	<b>854,00 €</b>
<b>2030GOFBVE2B</b>	56W 5820lm + 56W 5820lm - 220V	<b>788,00 €</b>
<b>2030GDMBVE2B</b>	DALI(Push) 56W 5820lm + 56W 5820lm - 220V	<b>891,00 €</b>
<b>2030HOFBVE2B</b>	63W 6500lm + 63W 6500lm - 220V	<b>814,00 €</b>
<b>2030HDMBVE2B</b>	DALI(Push) 63W 6500lm + 63W 6500lm - 220V	<b>918,00 €</b>
<b>2030LOFBVE2B</b>	88W 9140lm + 88W 9140lm - 220V	<b>1.432,00 €</b>
<b>2030LDMBVE2B</b>	DALI(Push) 88W 9140lm + 88W 9140lm - 220V	<b>1.634,00 €</b>
<b>2030MOFBVE2B</b>	112W 11640lm + 112W 11640lm - 220V	<b>1.566,00 €</b>
<b>2030MDMBVE2B</b>	DALI(Push) 112W 11640lm + 112W 11640lm - 220V	<b>1.772,00 €</b>
<b>2030NOFBVE2B</b>	126W 13000lm + 126W 13000lm - 220V	<b>1.741,00 €</b>
<b>2030NDMBVE2B</b>	DALI(Push) 126W 13000lm + 126W 13000lm - 220V	<b>1.952,00 €</b>

Configura

Configure / Konfigurieren

[www.teamitaliailluminazione.it](http://www.teamitaliailluminazione.it)



A 2700K  C 4000K

NE



**A** Alimentatore Incorporato - Incorporated Power Supply - Eingebautes Netzteil

\* 4570lm effettivi - effective - effektive con - with - mit E2

CODICE COMPLETO DEL PRODOTTO NELLA FOTO  
FULL PRODUCT CODE AS SHOWN IN PICTURE - VOLLSTÄNDIGER CODE VOM ARTIKEL IM BILD

**2030FOF** **NE** **E2** **B**

Codice  
Code

Finitura  
Finishing  
Lackierung

Diffusore  
Diffuser  
Diffusor

Tonalità  
Hue  
Farbton



# MIRÓ APPLIQUE

UPLIGHT - DOWNLIGHT

PARETE  
WALL LIGHT  
WANDLEUCHTE



configurazione standard: / basic configuration: / Standard Konfiguration:

E2 Opale - Opal

B 3000K

BV

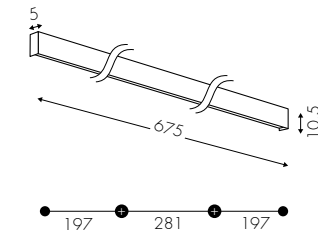

**2030OOFBVE2B**  
**2030ODMBVE2B**

151W 15640lm\* + 151W 15640lm - 220V  
DALI(Push) 151W 15640lm + 151W 15640lm - 220V

**2.210,00 €**  
**2.527,00 €**



**2030POFBVE2B**  
**2030PDMBVE2B**

175W 18140lm + 175W 18140lm - 220V  
DALI(Push) 175W 18140lm + 175W 18140lm - 220V

**2.488,00 €**  
**2.813,00 €**

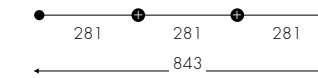

**2030QOFBVE2B**  
**2030QDMBVE2B**

189W 19500lm + 189W 19500lm - 220V  
DALI(Push) 189W 19500lm + 189W 19500lm - 220V

**2.671,00 €**  
**3.002,00 €**

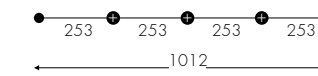

**2030ROFBVE2B**  
**2030RDMBVE2B**

224W 23280lm + 224W 23280lm - 220V  
DALI(Push) 224W 23280lm + 224W 23280lm - 220V

**3.461,00 €**  
**3.899,00 €**

Configura

Configure / Konfigurieren

[www.teamitaliailluminazione.it](http://www.teamitaliailluminazione.it)



A 2700K  C 4000K

NE



**CODICE COMPLETO DEL PRODOTTO NELLA FOTO**  
FULL PRODUCT CODE AS SHOWN IN PICTURE - VOLLSTÄNDIGER CODE VOM ARTIKEL IM BILD

**2030ROF** **NE** **E2** **B**

Codice  
Code

Finitura  
Finishing  
Lackierung

Diffusore  
Diffuser  
Diffusor

Tonalità  
Hue  
Farbton

Alimentatore Incorporato  
Incorporated Power Supply - Eingebautes Netzteil

\* 15640lm effettivi - effective - effektive con - with - mit E2

INDEX

SECTION

FAMILY



# EMME 24 INCASSO

INCASSO  
RECESSED LIGHT  
EINBAULEUCHTE



configurazione standard: / basic configuration: / Standard Konfiguration:

E2 Opale

● B 3000K

BV

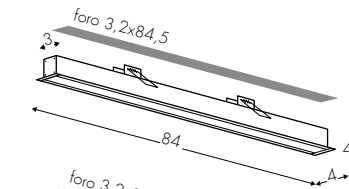

4037ABVE2B

19W 1435lm\* - 24VDC

163,00 €

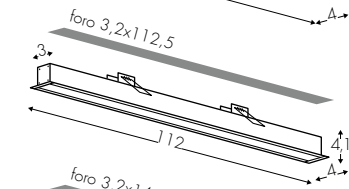

4037BBVE2B

25W 1910lm - 24VDC

233,00 €

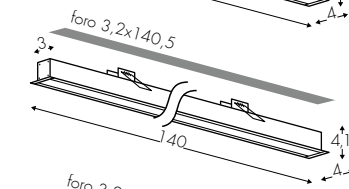

4037CBVE2B

31W 2385lm - 24VDC

271,00 €

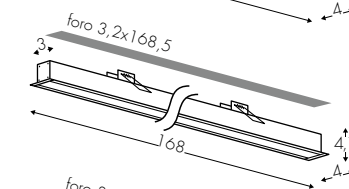

4037DBVE2B

37W 2860lm - 24VDC

324,00 €

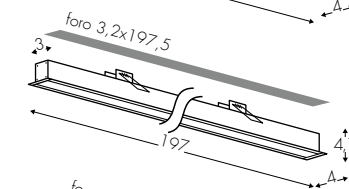

4037EBVE2B

44W 3350lm - 24VDC

352,00 €

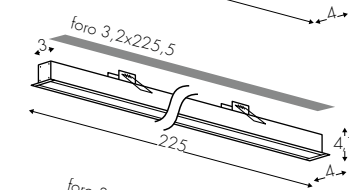

4037FBVE2B

50W 3830lm - 24VDC

373,00 €

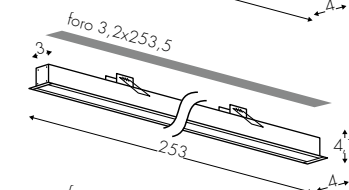

4037GBVE2B

56W 4305lm - 24VDC

395,00 €

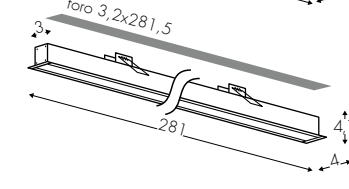

4037HBVE2B

62W 4780lm - 24VDC

417,00 €

Configura

Configure / Konfigurieren

[www.teamitaliailluminazione.it](http://www.teamitaliailluminazione.it)



Opal E19 UGR<19 Prism

C 4000K

NE



**CODICE COMPLETO DEL PRODOTTO NELLA FOTO**  
FULL PRODUCT CODE AS SHOWN IN PICTURE - VOLLSTÄNDIGER CODE VOM ARTIKEL IM BILD

**4037H**

Codice  
Code

**BV**

Finitura  
Finishing  
Lackierung

**E2**

Diffusore  
Diffuser  
Diffusor

**B**

Tonalità  
Hue  
Farbton

Alimentatore non incluso - Power Supply not included - Netzteil nicht inbegriffen

**Alimentatori a pag. 564-565 - Drivers p. 564-565 - Netzteil p. 564-565**

\* 1435lm effettivi - effective - effektive con - with - mit E2

1680lm effettivi - effective - effektive con - with - mit E19 +17,5%

configurazione standard: / basic configuration: / Standard Konfiguration:

E2 Opale

 B 3000K

BV 

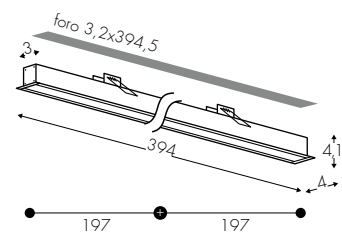

4037LBVE2B

87W 6705lm - 24VDC

775,00 €

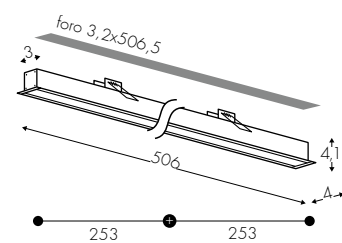

4037MBVE2B

111W 8605lm - 24VDC

969,00 €

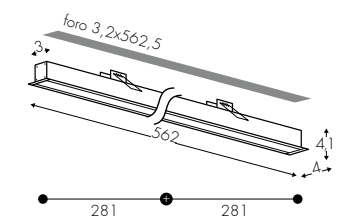

4037NBVE2B

124W 9560lm - 24VDC

1.072,00 €

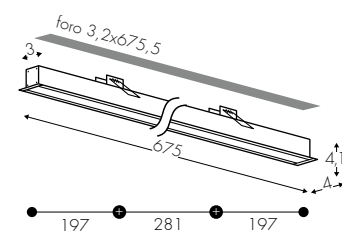

4037OBVE2B

148,5W 11485lm - 24VDC

1.297,00 €

Configura  Configure / Konfigurieren

[www.teamitaliailluminazione.it](http://www.teamitaliailluminazione.it) 



Opal E19 UGR<19 Prism  C 4000K

NE 

configurazione standard: / basic configuration: / Standard Konfiguration:

E2 Opale

 B 3000K

BV 

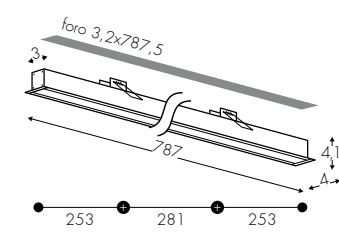

4037PBVE2B

173W 13380lm\* - 24VDC

1.526,00 €

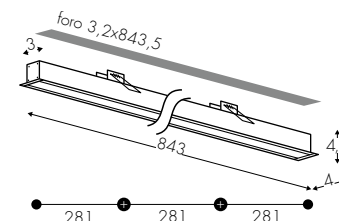

4037QBE2B

185W 14340lm - 24VDC

1.709,00 €

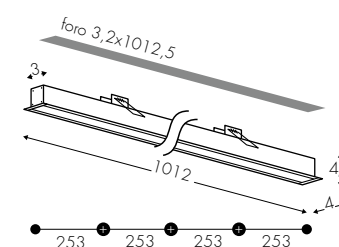

4037RBE2B

223W 17210lm - 24VDC

2.050,00 €

Configura  Configure / Konfigurieren

[www.teamitaliailluminazione.it](http://www.teamitaliailluminazione.it) 



Opal E19 UGR<19 Prism  C 4000K

NE 

CODICE COMPLETO • COMPLETE CODE • VOLLSTÄNDIGE CODE

**4037L**

Codice  
Code

**BV**

Finitura  
Finishing  
Lackierung

**E2**

Diffusore  
Diffuser  
Diffusor

**B**

Tonalità  
Hue  
Farbton

 Alimentatore non incluso - Power Supply not included - Netzteil nicht inbegriffen

**Alimentatori a pag. 564-565 - Drivers p. 564-565 - Netzteil p. 564-565**

\* 13380lm effettivi - effective - effektive con - with - mit E2

15740lm effettivi - effective - effektive con - with - mit E19  +17,5%



# EMME 24 INCASSO

INCASSO  
RECESSED LIGHT  
EINBAULEUCHTE



configurazione standard: / basic configuration: / Standard Konfiguration:

E2 Opale

B 3000K

BV

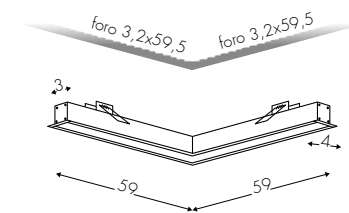

4037KGABVE2B

25W 1905lm\* - 24VDC

376,00 €

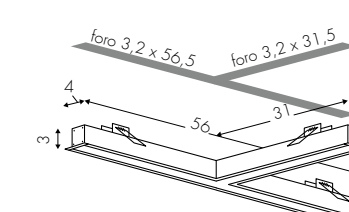

4037KGTBVE2B

19W 1430lm - 24VDC

444,00 €

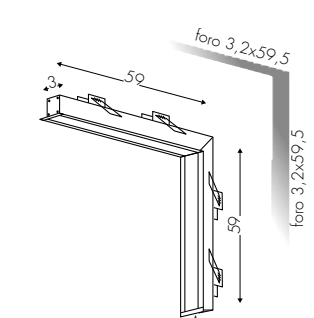

4037KGVBE2B

25W 1905lm - 24VDC

376,00 €

Configura

Configure / Konfigurieren

[www.teamitaliailluminazione.it](http://www.teamitaliailluminazione.it)



Opal E19 UGR<19 Prism

C 4000K

NE



CODICE COMPLETO DEL PRODOTTO NELLA FOTO  
FULL PRODUCT CODE AS SHOWN IN PICTURE - VOLLSTÄNDIGER CODE VOM ARTIKEL IM BILD

**4037KGA** **BV** **E2** **B**

Codice  
Code

Finitura  
Finishing  
Lackierung

Diffusore  
Diffuser  
Diffusor

Tonalità  
Hue  
Farbton

Alimentatore non incluso - Power Supply not included - Netzteil nicht inbegriffen  
**Alimentatori a pag. 564-565 - Drivers p. 564-565 - Netzteil p. 564-565**

\* 1905lm effettivi - effective - effektive con - with - mit E2  
2240lm effettivi - effective - effektive con - with - mit E19 +17,5%



# MIRÓ INCASSO

INCASSO  
RECESSED LIGHT  
EINBAULEUCHTE



configurazione standard: / basic configuration: / Standard Konfiguration:

E2 Opale

● B 3000K

BV

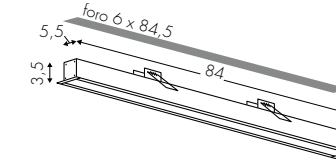

**4030AOFBVE2B**  
**4030ADMBVE2B**

26W 2260lm\* - 220V  
DALI(Push) 26W 2260lm - 220V

**329,00 €**  
**374,00 €**

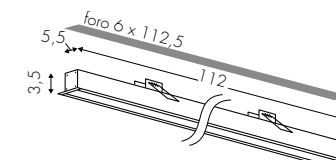

**4030BOFBVE2B**  
**4030BDMBVE2B**

35W 3010lm - 220V  
DALI(Push) 35W 3010lm - 220V

**336,00 €**  
**391,00 €**

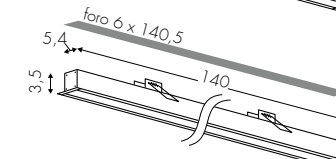

**4030COFBVE2B**  
**4030CDMBVE2B**

44W 3765lm - 220V  
DALI(Push) 44W 3765lm - 220V

**379,00 €**  
**435,00 €**

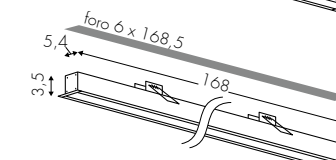

**4030DOFBVE2B**  
**4030DDMBVE2B**

53W 4515lm - 220V  
DALI(Push) 53W 4515lm - 220V

**395,00 €**  
**464,00 €**

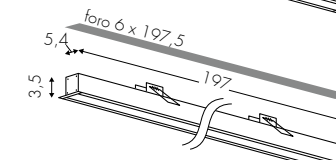

**4030EOFBVE2B**  
**4030EDMBVE2B**

62W 5265lm - 220V  
DALI(Push) 62W 5265lm - 220V

**411,00 €**  
**469,00 €**

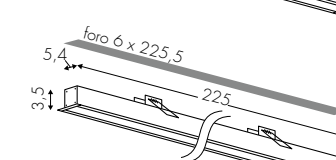

**4030FOFBVE2B**  
**4030FDMBVE2B**

70W 6020lm - 220V  
DALI(Push) 70W 6020lm - 220V

**508,00 €**  
**567,00 €**

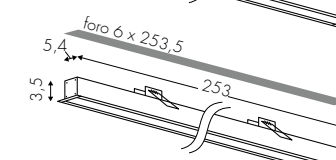

**4030GOFBVE2B**  
**4030GDMBVE2B**

79W 6775lm - 220V  
DALI(Push) 79W 6775lm - 220V

**566,00 €**  
**641,00 €**

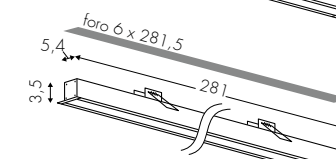

**4030HOFBVE2B**  
**4030HDMBVE2B**

88W 7525lm - 220V  
DALI(Push) 88W 7525lm - 220V

**613,00 €**  
**660,00 €**

Configura

Configure / Konfigurieren

[www.teamitaliailluminazione.it](http://www.teamitaliailluminazione.it)



Opal E19 UGR<19 Prism

C 4000K

NE



Alimentatore Incluso in remoto - Remote Power Supply - Fernspeisung enthalten

\* 2260lm effettivi - effective - effektive con - with - mit E2  
2655lm effettivi - effective - effektive con - with - mit E19 +17,5%



CODICE COMPLETO DEL PRODOTTO NELLA FOTO  
FULL PRODUCT CODE AS SHOWN IN PICTURE - VOLLSTÄNDIGER CODE VOM ARTIKEL IM BILD

**4030DOF** **BV** **E2** **B**

Codice  
Code

Finitura  
Finishing  
Lackierung

Diffusore  
Diffuser  
Diffusor

Tonalità  
Hue  
Farbton

configurazione standard: / basic configuration: / Standard Konfiguration:

E2 Opale

 B 3000K

BV

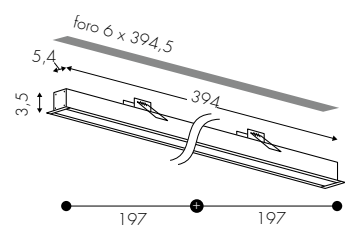

**4030LOFBVE2B**  
**4030LDMBVE2B**

123W 10530lm - 220V  
DALI(Push) 123W 10530lm - 220V

**822,00 €**  
**937,00 €**

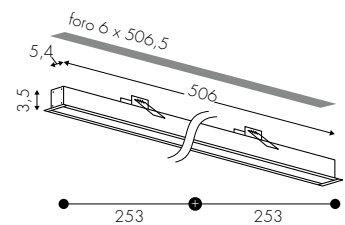

**4030MOFBVE2B**  
**4030MDMBVE2B**

158W 13550lm - 220V  
DALI(Push) 158W 13550lm - 220V

**1.132,00 €**  
**1.281,00 €**

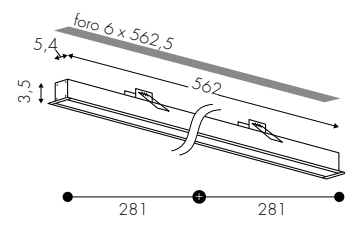

**4030NOFBVE2B**  
**4030NDMBVE2B**

176W 15050lm - 220V  
DALI(Push) 176W 15050lm - 220V

**1.225,00 €**  
**1.320,00 €**

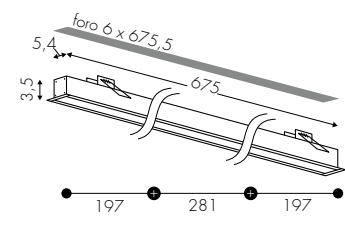

**4030OOFBVE2B**  
**4030ODMBVE2B**

212W 18060lm - 220V  
DALI(Push) 212W 18060lm - 220V

**1.435,00 €**  
**1.597,00 €**

Configura 

Configure / Konfigurieren

[www.teamitaliailluminazione.it](http://www.teamitaliailluminazione.it) 



Opal E19 UGR<19 Prism  C 4000K

 Alimentatore Incluso in remoto - Remote Power Supply - Fernspeisung enthalten

CODICE COMPLETO • COMPLETE CODE • VOLLSTÄNDIGE CODE

**4030LOF**

**BV**

**E2**

**B**

Codice  
Code

Finitura  
Finishing  
Lackierung

Diffusore  
Diffuser  
Diffusor

Tonalità  
Hue  
Farbton

configurazione standard: / basic configuration: / Standard Konfiguration:

E2 Opale

 B 3000K

BV

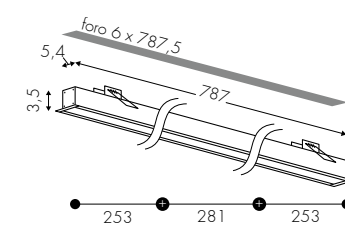

**4030POFBVE2B**  
**4030PDMBVE2B**

246W 21070lm\* - 220V  
DALI(Push) 246W 21070lm - 220V

**1.744,00 €**  
**1.941,00 €**

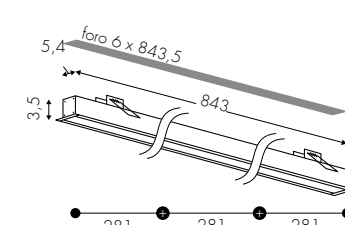

**4030QOFBVE2B**  
**4030QDMBVE2B**

264W 22575lm - 220V  
DALI(Push) 264W 22575lm - 220V

**1.838,00 €**  
**1.979,00 €**

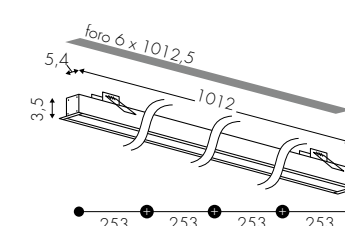

**4030ROFBVE2B**  
**4030RDMBVE2B**

317W 27090lm - 220V  
DALI(Push) 317W 27090lm - 220V

**2.195,00 €**  
**2.561,00 €**

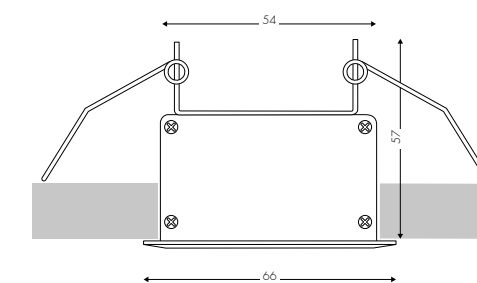

Configura 

Configure / Konfigurieren

[www.teamitaliailluminazione.it](http://www.teamitaliailluminazione.it) 



Opal E19 UGR<19 Prism  C 4000K

 Alimentatore Incluso in remoto - Remote Power Supply - Fernspeisung enthalten

\* 21070lm effettivi - effective - effektive con - with - mit E2  
24780lm effettivi - effective - effektive con - with - mit E19  +17,5%





# MIRÓ INCASSO

INCASSO  
RECESSED LIGHT  
EINBAULEUCHTE

configurazione standard: / basic configuration: / Standard Konfiguration:

E2 Opale

● B 3000K

BV

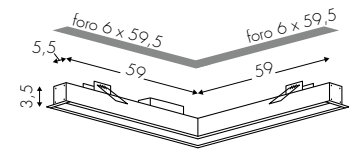

**4030KGAOFBVE2B** 35W 3010lm\* - 220V **430,00 €**  
**4030KADMBVE2B** DALI(Push) 35W 3010lm - 220V **495,00 €**

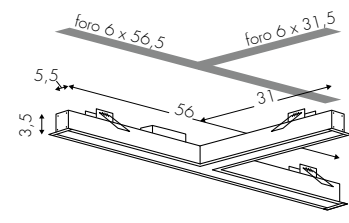

**4030KGTDFBVE2B** 26W 2250lm - 220V **535,00 €**  
**4030KGTDMBVE2B** DALI(Push) 26W 2250lm - 220V **602,00 €**

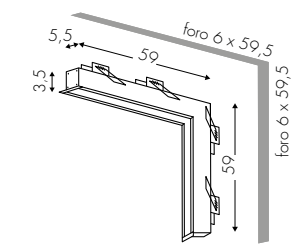

**4030KGVDFBVE2B** 35W 3010lm - 220V **430,00 €**  
**4030KGVDMBVE2B** DALI(Push) 35W 3010lm - 220V **495,00 €**

Configura

Configure / Konfigurieren

[www.teamitaliailluminazione.it](http://www.teamitaliailluminazione.it)



Opal E19 UGR<19 Prism

C 4000K

NE

**CODICE COMPLETO DEL PRODOTTO NELLA FOTO**  
**FULL PRODUCT CODE AS SHOWN IN PICTURE - VOLLSTÄNDIGER CODE VOM ARTIKEL IM BILD**

**4030KGAOF** **BV** **E2** **B**

Codice  
Code

Finitura  
Finishing  
Lackierung

Diffusore  
Diffuser  
Diffusor

Tonalità  
Hue  
Farbton

Alimentatore Incluso in remoto - Remote Power Supply - Fernspeisung enthalten

\* 3010lm effettivi - effective - effektive con - with - mit **E2**  
 3540lm effettivi - effective - effektive con - with - mit **E19** **+17,5%**



configurazione standard: / basic configuration: / Standard Konfiguration:

E2 Opale - Opal ● B 3000K

BV

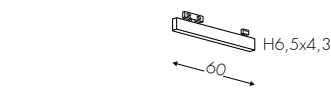

**T058UOFBVE2B**

9W 1010lm\* - 220V

**313,00 €**

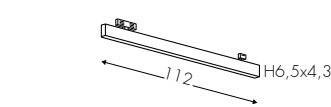

**T058BOFBVE2B**

18W 2025lm - 220V

**423,00 €**

**T058BDMBVE2B**

DALI (Push) - 18W 2025lm - 220V

**483,00 €**

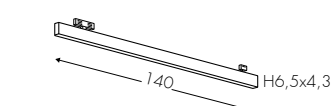

**T058COFBVE2B**

22W 2530lm - 220V

**469,00 €**

**T058CDMBVE2B**

DALI (Push) - 22W 2530lm - 220V

**531,00 €**

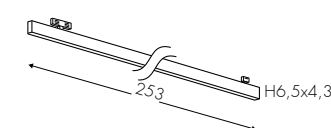

**T058GOFBVE2B**

39W 4510lm - 220V

**641,00 €**

**T058GDMBVE2B**

DALI (Push) - 39W 4510lm - 220V

**714,00 €**

Configura 

Configure / Konfigurieren

[www.teamitaliailluminazione.it](http://www.teamitaliailluminazione.it) 

E19 UGR<19 Prism

● A 2700K ○ C 4000K

NE RU 

A Alimentatore Incorporato - Incorporated Power Supply - Eingebautes Netzteil

\* 1010lm effettivi - effective - effektive con - with - mit **E2**  
1190lm effettivi - effective - effektive con - with - mit **E19** ↻ +17,5%

 **CODICE COMPLETO DEL PRODOTTO NELLA FOTO**  
FULL PRODUCT CODE AS SHOWN IN PICTURE - VOLLSTÄNDIGER CODE VOM ARTIKEL IM BILD

**T058UOF** **BV** **E2** **B**

Codice  
Code

Finitura  
Finishing  
Lackierung

Diffusore  
Diffuser  
Diffusor

Tonalità  
Hue  
Farbton



configurazione standard: / basic configuration: / Standard Konfiguration:

E2 Opale - Opal ● B 3000K

BV

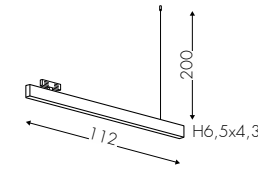

**T058BSOFBVE2B** 18W 2025lm\* - 220V 423,00 €  
**T058BSDMBVE2B** DALI (Push) - 18W 2025lm - 220V 483,00 €

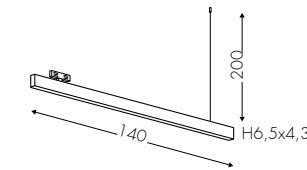

**T058CSOFBVE2B** 22W 2530lm - 220V 469,00 €  
**T058CSDMBVE2B** DALI (Push) - 22W 2530lm - 220V 531,00 €

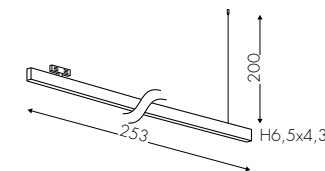

**T058HSOFBVE2B** 39W 4510lm - 220V 641,00 €  
**T058HSDMBVE2B** DALI (Push) - 39W 4510lm - 220V 714,00 €

Configura  Configure / Konfigurieren

[www.teamitaliailluminazione.it](http://www.teamitaliailluminazione.it) 



E19 UGR<19 Prism ● A 2700K  C 4000K



A Alimentatore Incorporato - Incorporated Power Supply - Eingebautes Netzteil

\* 2025lm effettivi - effective - effektive con - with - mit **E2**  
 2380lm effettivi - effective - effektive con - with - mit **E19** ↻ +17,5%

 CODICE COMPLETO DEL PRODOTTO NELLA FOTO  
 FULL PRODUCT CODE AS SHOWN IN PICTURE - VOLLSTÄNDIGER CODE VOM ARTIKEL IM BILD

**T058BSOF** **BV** **E2** **B**

Codice Code Finitura Finishing Diffusore Diffuser Tonalità Hue  
 Code Lackierung Diffusor Farbton



Sistema binario 48V  
Track system 48V  
Gleis 48V

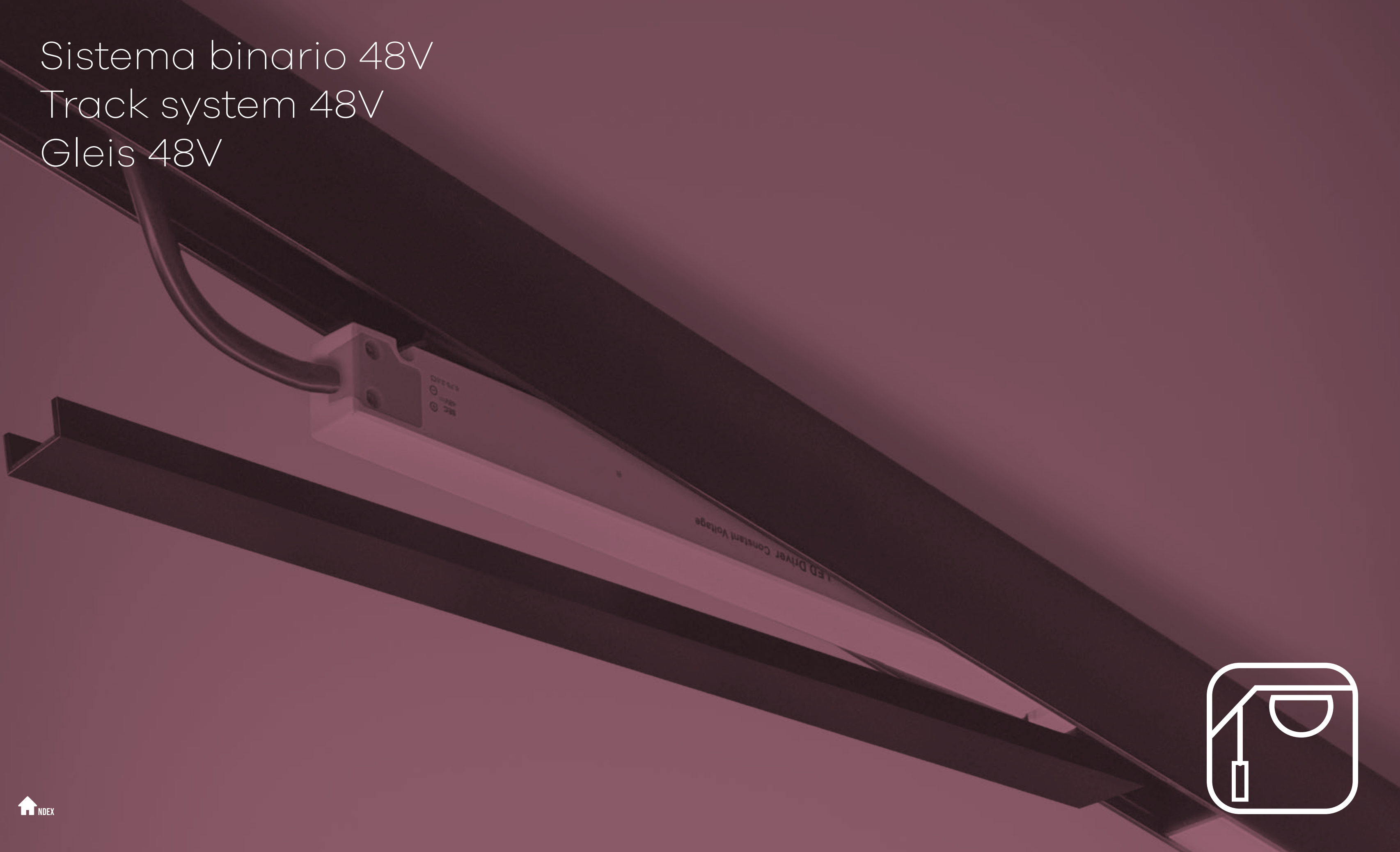



**B48 PLAFONE**



**504**



**B48 SOSPENSIONE**



**505**



**B48 SOSPENSIONE UPLIGHT**

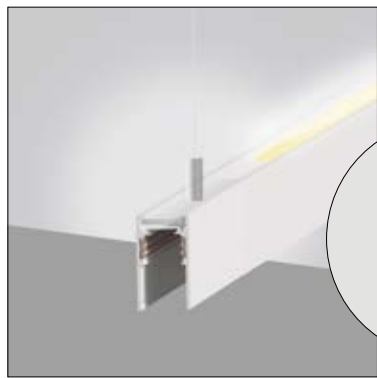

**505**

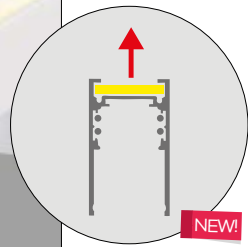

**B48 INCASSO**



**506**

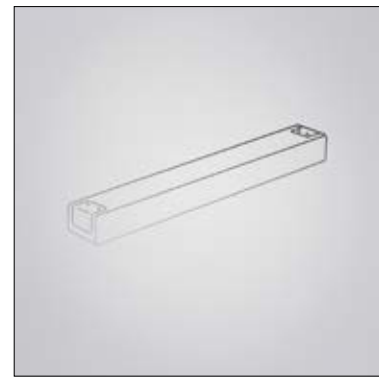

**B48 KIT DRIVER**

**508**



**B48 CURVE**

Sospensione downlight L130/165/270

**511**



**B48 EDGE**

Sospensione downlight 31x115/143x59

**513**



**B48 EDGE**

Sospensione Uplight 87x87

**513**



**B48 LAMBDA**

Sospensione Ø20/Ø30

**515**



**B48 LAMBDA**

Binario Ø20/Ø30

**515**



**B48 LICIS**

Sospensione Ø20

**517**



**B48 LICIS**

Binario Ø20

**517**



**B48 LIEVE**

Sospensione L125

**519**

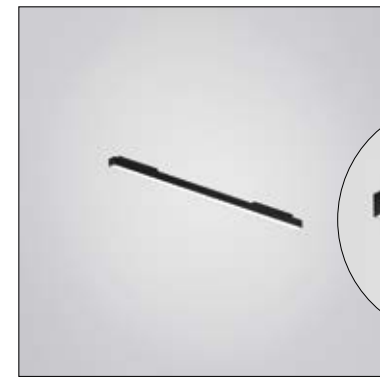

**B48 LIEVE**

Binario L60

**519**



**B48 LINEA DARK** 521  
Sospensione L150

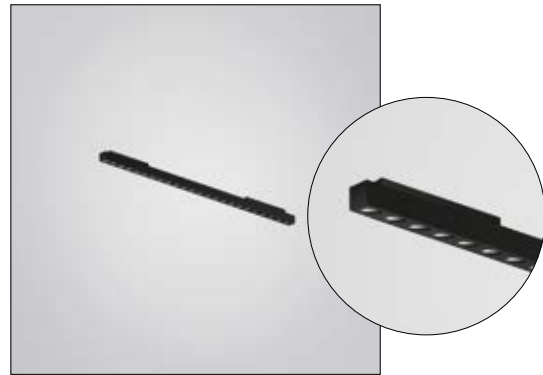

**B48 LINEA DARK** 521  
Binario L22 / 44cm



**B48 MICRO** 525  
L30/50



**B48 OKI** 529  
8x8



**B48 OVERLAP DECO'** 531  
Sospensione up+downlight 75x133



**B48 OVERLAP DECO'** 531  
Sospensione up+downlight 94,5x94,5/87x184



**B48 OVERLAP** 533  
Sospensione L120



**B48 OVERLAP** 533  
Binario L60



**B48 SHADOW** 535  
Sospensione Orizzontale Ø70/Ø95



**B48 SHADOW** 535  
Sospensione Verticale Ø58/Ø70



**B48 SPOTLIGHT** 537  
Binario 4/7/12/18W



**B48 MELLOW** 523  
Sospensione Ø15 x H16



**B48 MELLOW** 523  
Binario Ø15 x H16



**B48 TUBICO** 539  
Sospensione L30/60/90



**B48 OGIS** 527  
Sospensione Ø13,5 x H15



**B48 OGIS** 527  
Binario Ø13,5 x H15



**B48 VENIS** 541  
Sospensione Ø20



**B48 VENIS** 541  
Binario Ø20



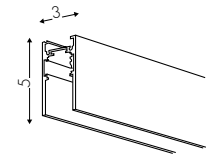

9074A48

Track plafone sospensione 48V DC 2mt  
Ceiling suspension Track 48V DC 2mt

BV NE  
143,00 €

\*SERVIZIO SU MISURA (S.M.)



001001A

Taglio - Cut service

10,00 €

Configura

Configure / Konfigurieren

[www.teamitaliailluminazione.it](http://www.teamitaliailluminazione.it)

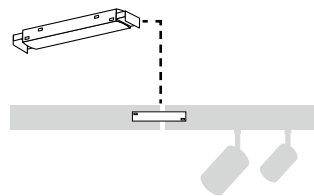

9074P48

Giunto elettrico lineare - Linear electrical joint  
Elektrischen Steckverbinder

49,00 €

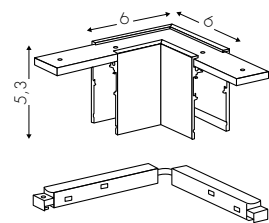

9074C48

Angolare - Corner - Ecke

128,00 €

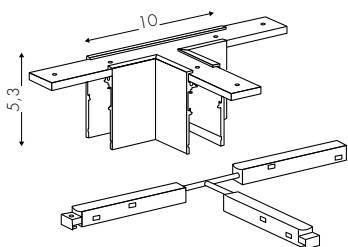

9074D48

Giunto a T - T Connection

187,00 €

Configura

Configure / Konfigurieren

[www.teamitaliailluminazione.it](http://www.teamitaliailluminazione.it)

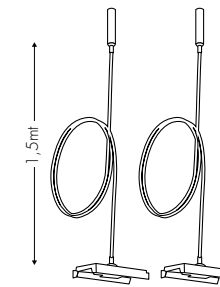

9074F48

Coppia accessori sospensione - Couple of accessories suspension  
Paar Zubehör Aufhängung

NE  
40,00 €

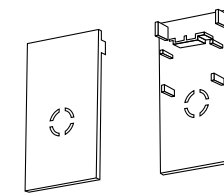

9074B48

Coppia di testate - Couple Endcaps - Paar Endkappen

BV NE  
10,00 €

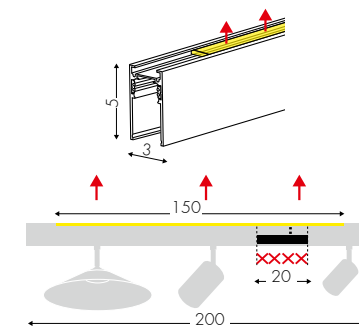

9074U48

Uplight track sospensione 48V DC (2mt) - 33W 4000lm  
Uplight suspension track 48V DC (2mt) - 33W 4000lm

248,00 €

Configure / Konfigurieren

Configura

[www.teamitaliailluminazione.it](http://www.teamitaliailluminazione.it)



CODICE COMPLETO • COMPLETE CODE • VOLLSTÄNDIGE CODE

**9074A48** **NE**

Codice  
Code

Finitura  
Finishing  
Lackierung

CODICE COMPLETO • COMPLETE CODE • VOLLSTÄNDIGE CODE

**9074U48** **NE**

Codice  
Code

Finitura  
Finishing  
Lackierung

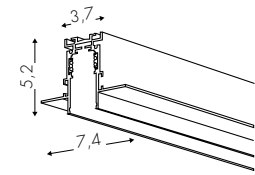

9074I48

Track incasso 48V DC 2mt  
Recessed Track 48v DC 2mt

BV NE  
□ ■  
185,00 €

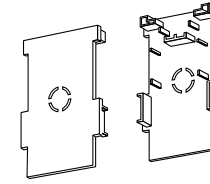

9074L48

Coppia di testate - Couple Endcaps - Paar Endkappen

BV NE  
□ ■  
10,00 €

\*SERVIZIO SU MISURA (S.M.)



001001A

Taglio - Cut service

10,00 €

Configura

Configure / Konfigurieren

[www.teamitaliailluminazione.it](http://www.teamitaliailluminazione.it)

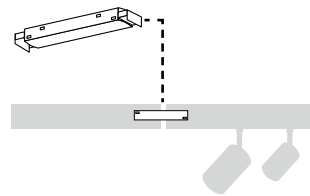

9074P48

Giunto elettrico lineare  
Linear electrical joint - Elektrischen Steckverbinder

49,00 €

Configura

Configure / Konfigurieren

[www.teamitaliailluminazione.it](http://www.teamitaliailluminazione.it)

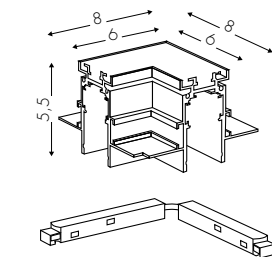

9074M48

Angolare - Corner - Ecke

144,00 €

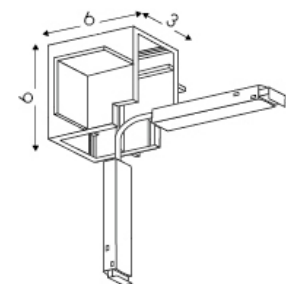

9074O48

Angolare verticale - Vertical Corner - Vertikal Ecke

144,00 €

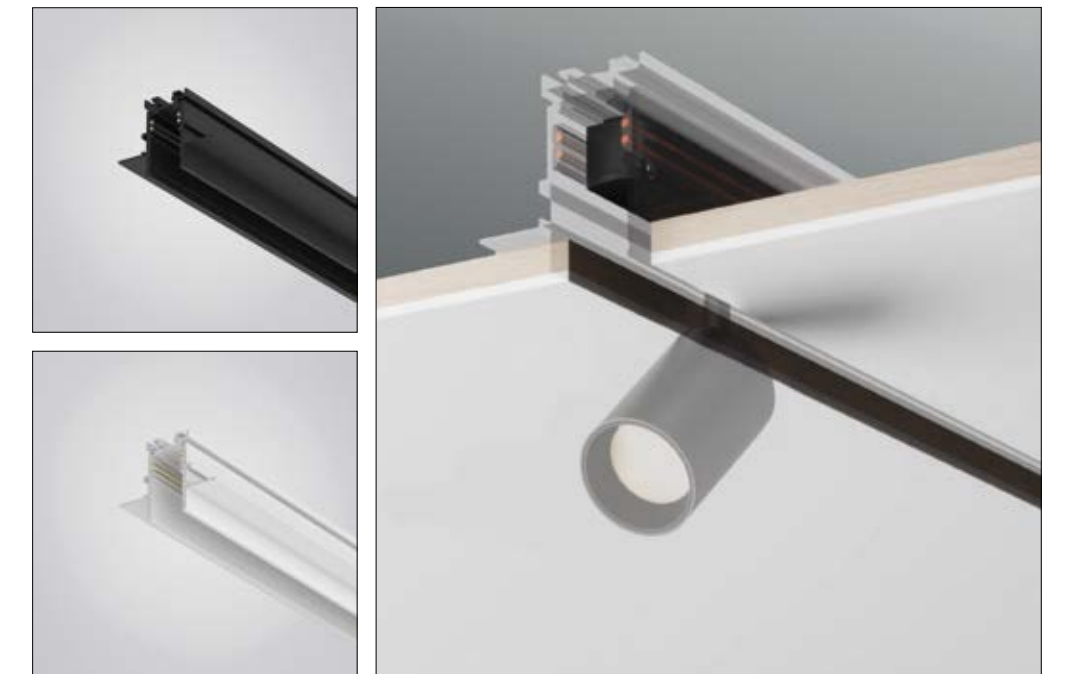

CODICE COMPLETO • COMPLETE CODE • VOLLSTÄNDIGE CODE

**9074I48** **NE**

Codice  
Code

Finitura  
Finishing  
Lackierung

CODICE COMPLETO • COMPLETE CODE • VOLLSTÄNDIGE CODE

**9074L48** **NE**

Codice  
Code

Finitura  
Finishing  
Lackierung



BV NE



## DRIVER INSIDE (nel binario - inside track - in Gleis)

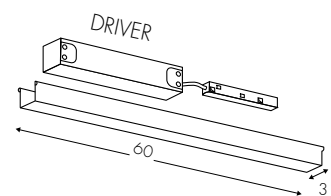

**9074H48**

Kit driver inside 100W 48VDC  
+ cover + connettore connector ON/OFF

150,00 €

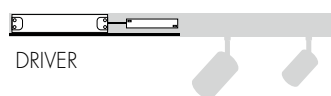

## DRIVER OUTSIDE (remoto - remote - entfernt gelegen)

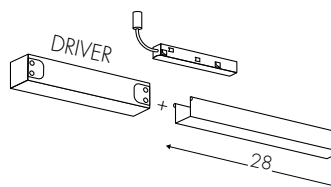

**9074HB48TF**

Kit driver outside 100W 48V DC Triac

260,00 €

**9074GB48**

Kit driver outside 150W - 48V DC ON/OFF

188,00 €

**9074GB48TF**

Kit driver outside 150W 48V DC Triac

330,00 €

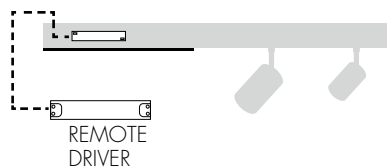

## ACCESSORIES

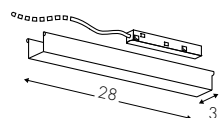

**9074Z48**

Kit connettore - connection kit + cover - NO DRIVER

65,00 €



NO DRIVER



**9074Q48**

B48 - Cover L200cm

29,00 €

Configura Configura / Konfigurieren

[www.teamitaliailluminazione.it](http://www.teamitaliailluminazione.it)

## ESEMPIO 1 PLAFONE

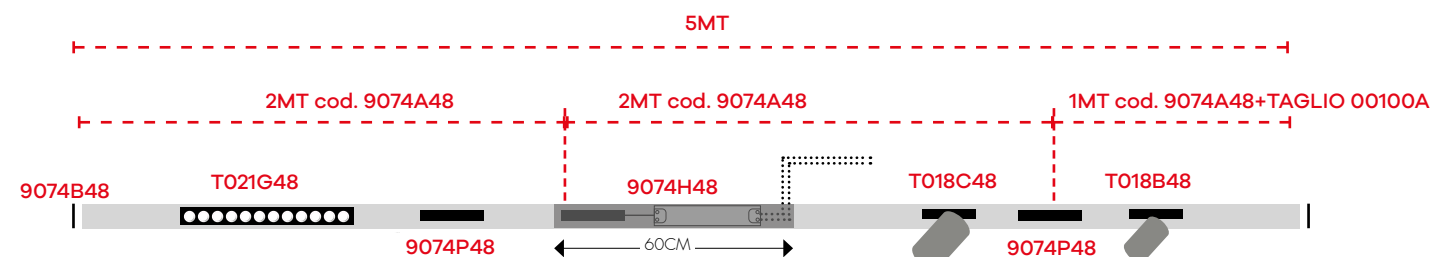

## ESEMPIO 2 INCASSO

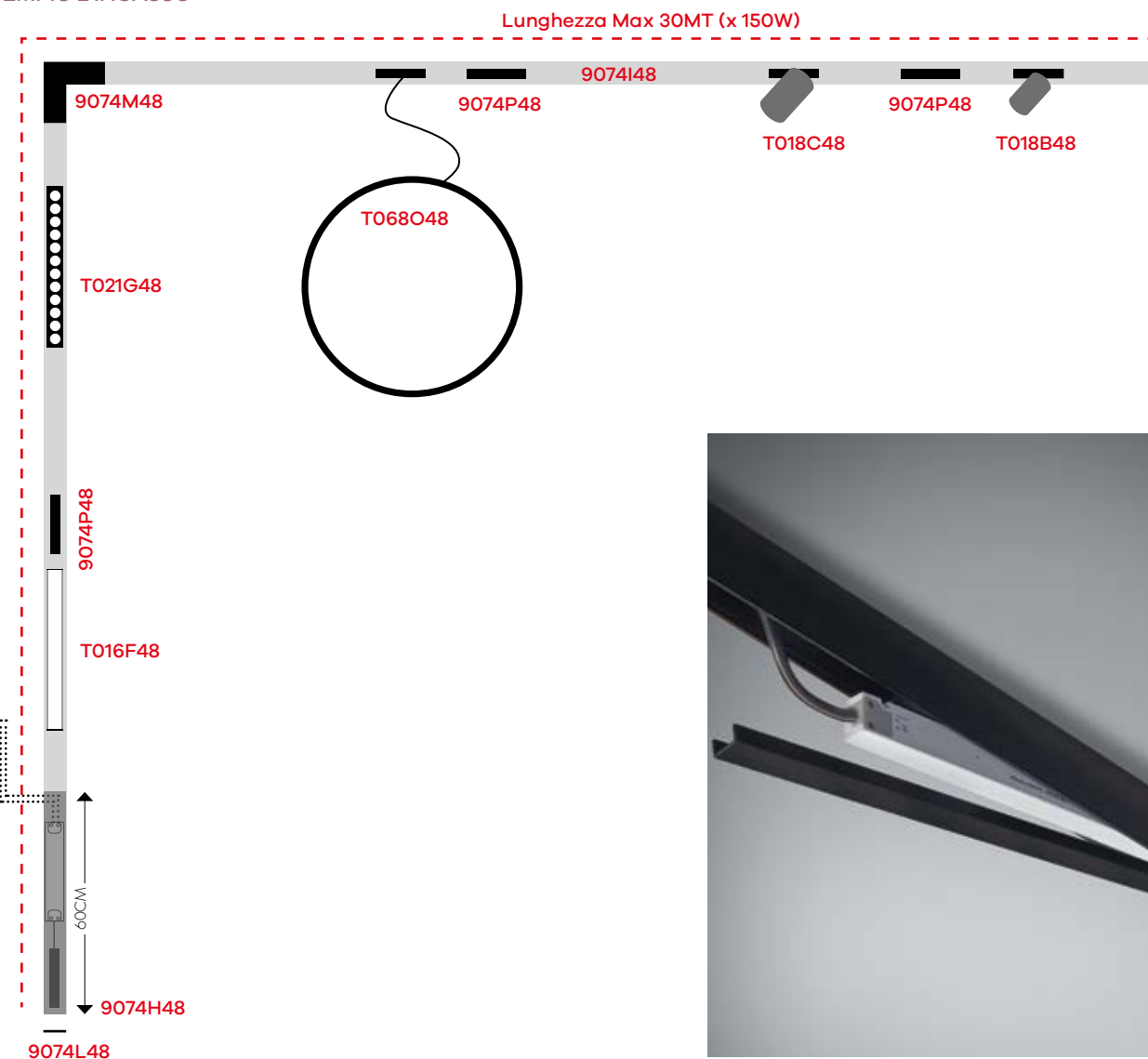

CODICE COMPLETO • COMPLETE CODE • VOLLSTÄNDIGE CODE

**9074H48** **NE**

Codice  
Code

Finitura  
Finishing  
Lackierung





# SISTEMA B48

configurazione standard: / basic configuration: / Standard Konfiguration:

E2 Opale - Opal

B 3000K

BV

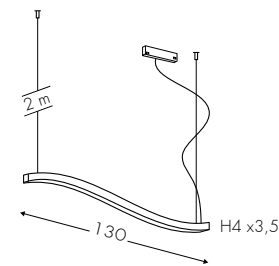

**T022N48NEE2B**

35W 3570lm\* - 48V DC

**567,00 €**

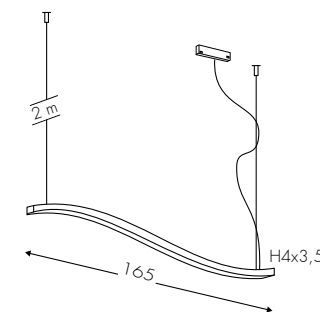

**T022M48NEE2B**

45W 3350lm - 48V DC

**609,00 €**

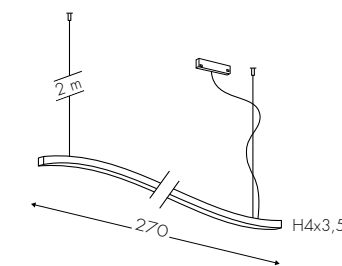

**T022H48NEE2B**

70W 5880lm - 48V DC

**803,00 €**



**0074A2**

Servizio doppia accensione  
Dual switch service - Service Doppelzündung

**50,00 €**

Configura

Configure / Konfigurieren

[www.teamitaliailluminazione.it](http://www.teamitaliailluminazione.it)



E19 Prismaticato - Prism

NE RU

**CODICE COMPLETO DEL PRODOTTO NELLA FOTO**  
FULL PRODUCT CODE AS SHOWN IN PICTURE - VOLLSTÄNDIGER CODE VOM ARTIKEL IM BILD

**T022M48** **NE** **E2** **B**

Codice  
Code

Finitura  
Finishing  
Lackierung

Diffusore  
Diffuser  
Diffusor

Tonalità  
Hue  
Farbton

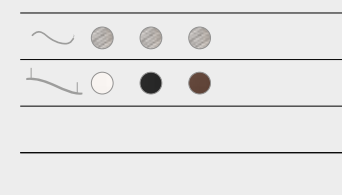

Alimentatore non incluso - Power Supply not included - Netzteil nicht enthalten

\* 3570lm effettivi - effective - effektive con - with - mit **E2**  
4200lm effettivi - effective - effektive con - with - mit **E19** **+17,5%**

# SISTEMA B48

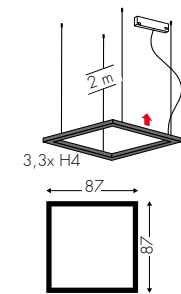
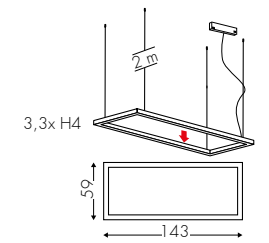
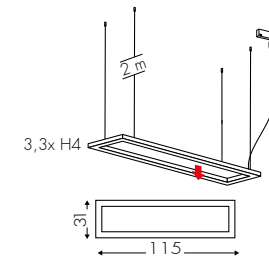

configurazione standard: / basic configuration: / Standard Konfiguration:

E2 Opale - Opal ● B 3000K BV

**T028N48BVE2B** 62W 4560lm\* - 48V DC **613,00 €**

**T028M48BVE2B** 75W 5470lm - 48V DC **940,00 €**

**0074A2** Servizio doppia accensione  
Dual switch service - Service Doppelzündung **50,00 €**

[Configura](#)  Configure / Konfigurieren

[www.teamitaliailluminazione.it](http://www.teamitaliailluminazione.it) 

E19 Prismatico - Prism NE

configurazione standard: / basic configuration: / Standard Konfiguration:

E28 Satinato  
Frosted - Satiniert ● B 3000K BV

**T028C48BVE28B** 75W 6435lm - 48V DC **819,00 €**

**0074A2** Servizio doppia accensione  
Dual switch service - Service Doppelzündung **50,00 €**

[Configura](#)  Configure / Konfigurieren

[www.teamitaliailluminazione.it](http://www.teamitaliailluminazione.it) 

 Alimentatore non incluso - Power Supply not included - Netzteil nicht enthalten

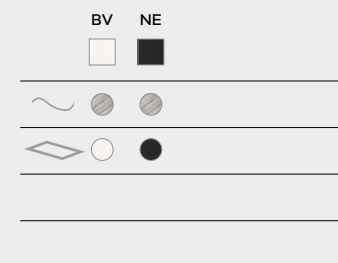

\* 4560lm effettivi - effective - effektive con - with - mit E2  
5358lm effettivi - effective - effektive con - with - mit E19 ↻ +17,5%

 CODICE COMPLETO DEL PRODOTTO NELLA FOTO  
FULL PRODUCT CODE AS SHOWN IN PICTURE - VOLLSTÄNDIGER CODE VOM ARTIKEL IM BILD

**T028M48** **NE** **E2** **B**

Codice Code	Finitura Finishing Lackierung	Diffusore Diffuser Diffusor	Tonalità Hue Farbton
----------------	-------------------------------------	-----------------------------------	----------------------------

# SISTEMA B48



configurazione standard: / basic configuration: / Standard Konfiguration:

E19 Prismatico - Prism

 B 3000K

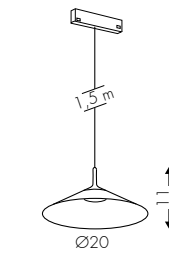

T071A48ONE19B

6.5W 800lm\* - 48V DC

292,00 €

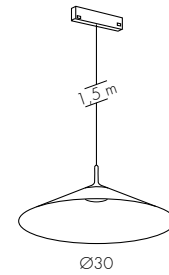

T071B48ONE19B

6.5W 800lm - 48V DC

372,00 €

Configura 

Configure / Konfigurieren

[www.teamitaliailluminazione.it](http://www.teamitaliailluminazione.it) 



T071F48ONE19B

6.5W 800lm - 48V DC

292,00 €



T071G48ONE19B

6.5W 800lm - 48V DC

372,00 €



0074A2

Servizio doppia accensione  
Dual switch service - Service Doppelzündung

50,00 €

Configura 

Configure / Konfigurieren

[www.teamitaliailluminazione.it](http://www.teamitaliailluminazione.it) 



 CODICE COMPLETO DEL PRODOTTO NELLA FOTO  
FULL PRODUCT CODE AS SHOWN IN PICTURE - VOLLSTÄNDIGER CODE VOM ARTIKEL IM BILD

**T071A48** **ZN** **E19** **B**

Codice  
Code

Finitura  
Finishing  
Lackierung

Diffusore  
Diffuser  
Diffusor

Tonalità  
Hue  
Farbton

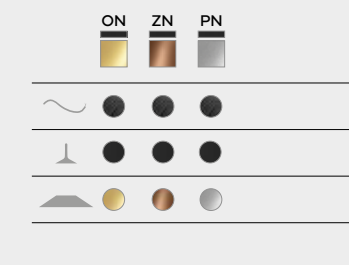

 Alimentatore non incluso - Power Supply not included - Netzteil nicht enthalten

\* 800lm effettivi - effective - effektive con - with - mit E19



# SISTEMA B48



configurazione standard: / basic configuration: / Standard Konfiguration:

E2 Opale - Opal  B 3000K 

**T073A48NTE2B** 6.5W 800lm\* - 48V DC **350,00 €**

[Configura](#)  Configure / Konfigurieren

[www.teamitaliailluminazione.it](http://www.teamitaliailluminazione.it) 

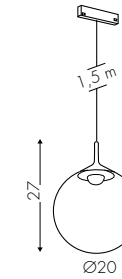

**T073F48NTE2B** 6.5W 800lm - 48V DC **350,00 €**

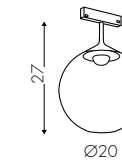

**0074A2** Servizio doppia accensione / Dual switch service - Service Doppelzündung **50,00 €**

[Configura](#)  Configure / Konfigurieren

[www.teamitaliailluminazione.it](http://www.teamitaliailluminazione.it) 



E2 Opale - Opal  B 3000K 

 Alimentatore non incluso - Power Supply not included - Netzteil nicht enthalten

\* 800lm effettivi - effective - effektive con - with - mit **E2**

 **CODICE COMPLETO DEL PRODOTTO NELLA FOTO**  
FULL PRODUCT CODE AS SHOWN IN PICTURE - VOLLSTÄNDIGER CODE VOM ARTIKEL IM BILD

**T073A48** **NF** **E2** **B**

Codice  
Code

Finitura  
Finishing  
Lackierung

Diffusore  
Diffuser  
Diffusor

Tonalità  
Hue  
Farbton

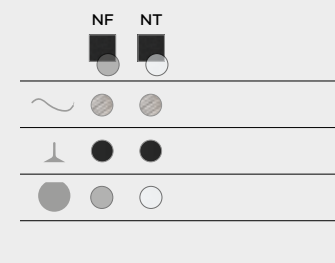

# SISTEMA B48



configurazione standard: / basic configuration: / Standard Konfiguration:

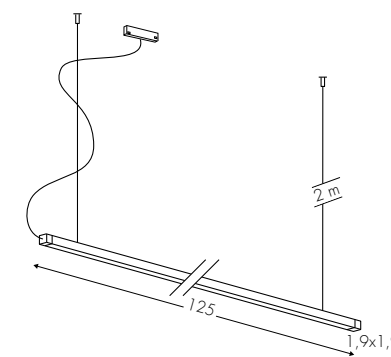

E2 Opale - Opal

B 3000K

BV



**T016B48BVE2B**

28W 1890lm\* - 48V DC

**310,00 €**



Configura 

Configure / Konfigurieren

[www.teamitaliailluminazione.it](http://www.teamitaliailluminazione.it) 

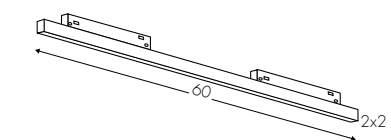

**T016F48BVE2B**

12W - 716lm - 48V DC

**160,00 €**



**0074A2**

Servizio doppia accensione  
Dual switch service - Service Doppelzündung

**50,00 €**

Configura 

Configure / Konfigurieren

[www.teamitaliailluminazione.it](http://www.teamitaliailluminazione.it) 

NE



**CODICE COMPLETO DEL PRODOTTO NELLA FOTO**  
FULL PRODUCT CODE AS SHOWN IN PICTURE  
VOLLSTÄNDIGER CODE VOM ARTIKEL IM BILD

**T016B48** **NE** **E2** **B**

Codice  
Code

Finitura  
Finishing  
Lackierung

Diffusore  
Diffuser  
Diffusor

Tonalità  
Hue  
Farbton

BV NE



 Alimentatore non incluso - Power Supply not included - Netzteil nicht enthalten

\*1890lm effettivi - effective - effektive con - with - mit E2



# SISTEMA B48

LINEA DARK 

configurazione standard: / basic configuration: / Standard Konfiguration:

E19 Prismatico - Prism  B 3000K

BV

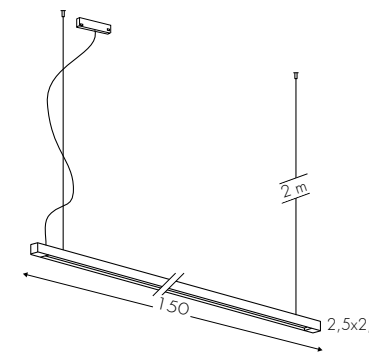

**T021A48BVE19B** 27W 2320lm\* - 48V DC **362,00 €**

[Configura](#)  Configure / Konfigurieren

[www.teamitaliailluminazione.it](http://www.teamitaliailluminazione.it) 

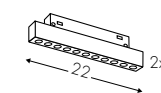

**T021F48BVE19B** 10W - 900lm - 48VDC **190,00 €**

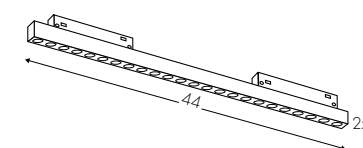

**T021G48BVE19B** 20W - 1800lm - 48V DC **278,00 €**



**0074A2** Servizio doppia accensione  
Dual switch service - Service Doppelzündung **50,00 €**

[Configura](#)  Configure / Konfigurieren

[www.teamitaliailluminazione.it](http://www.teamitaliailluminazione.it) 



NE

 Alimentatore non incluso - Power Supply not included - Netzteil nicht enthalten

\* 2320lm effettivi - effective - effektive con - with - mit E19

 **CODICE COMPLETO DEL PRODOTTO NELLA FOTO**  
FULL PRODUCT CODE AS SHOWN IN PICTURE  
VOLLSTÄNDIGER CODE VOM ARTIKEL IM BILD

**T021A48** **NE** **E19** **B**

Codice  
Code

Finitura  
Finishing  
Lackierung

Diffusore  
Diffuser  
Diffusor

Tonalità  
Hue  
Farbton

BV

NE

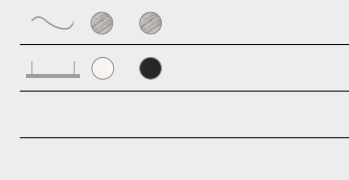

 INDEX

 SECTION

 FAMILY 521





configurazione standard: / basic configuration: / Standard Konfiguration:

E2 Opale - Opal - Opal  B 3000K 

**T1083A48BVE2B** 6,5W 1000lm\* - 48VDC **370,00 €**

[Configura](#)  Configure / Konfigurieren

[www.teamitaliailluminazione.it](http://www.teamitaliailluminazione.it) 

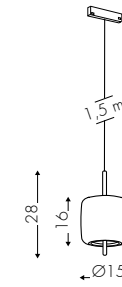

**T3083A48BVE2B** 6,5W 1000lm - 48VDC **370,00 €**

**0074A2** Servizio doppia accensione / Dual switch service - Service Doppelzündung **50,00 €**

**C005T2NE** Custom black cable **8,00 € /MT**

[Configura](#)  Configure / Konfigurieren

[www.teamitaliailluminazione.it](http://www.teamitaliailluminazione.it) 

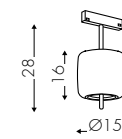

A

 A 2700K



 **CODICE COMPLETO DEL PRODOTTO NELLA FOTO**  
FULL PRODUCT CODE AS SHOWN IN PICTURE - VOLLSTÄNDIGER CODE VOM ARTIKEL IM BILD

**T3083A48** **BV** **E2** **B**

Codice Code

Finitura Finishing Lackierung

Diffusore Diffuser Diffusor

Tonalità Hue Farbton

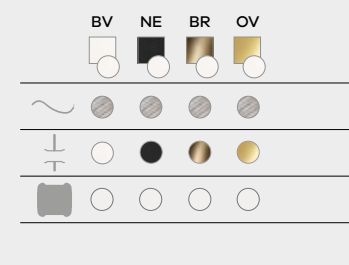

**TF** Taglio di Fase - Phase-Cut Dimmer - Phasenabschnittdimmer

**A** Alimentatore nel rosone - Power Supply inside the ceiling rose - Netzteil in der Deckendose

\* 1000lm effettivi - effective - effektive con - with - mit **E2**

# SISTEMA B48

MICRO 

configurazione standard: / basic configuration: / Standard Konfiguration:

24° Ottica - Optic - Optik  B 3000K 

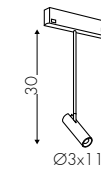

**T039A48BV24B**

3W 360lm\* - 350mA - 48V DC

**249,00 €**

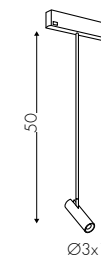

**T039B48BV24B**

3W 360lm - 350mA - 48V DC

**249,00 €**



**0074A2**

Servizio doppia accensione  
Dual switch service - Service Doppelzündung

**50,00 €**

[Configura](#)  [Configure / Konfigurieren](#)

[www.teamitaliailluminazione.it](http://www.teamitaliailluminazione.it) 



 Alimentatore non incluso - Power Supply not included - Netzteil nicht enthalten

\* 360lm effettivi - effective - effektive con - with - mit 24°



 **CODICE COMPLETO DEL PRODOTTO NELLA FOTO**  
FULL PRODUCT CODE AS SHOWN IN PICTURE - VOLLSTÄNDIGER CODE VOM ARTIKEL IM BILD

**T039B48** **NE** **24** **B**

Codice  
Code

Finitura  
Finishing  
Lackierung

Diffusore  
Diffuser  
Diffusor

Tonalità  
Hue  
Farbton

 [INDEX](#)

 [SECTION](#)

 [FAMILY](#) 525

# SISTEMA B48



configurazione standard: / basic configuration: / Standard Konfiguration:

E2 Opale - Opal - Opal  B 3000K 

**T1082A48BVE2B** 6,5W 680lm\* - 48VDC

**310,00 €**

[Configura](#)  Configure / Konfigurieren

[www.teamitaliailluminazione.it](http://www.teamitaliailluminazione.it) 



**T3082A48BVE2B** 6,5W 680lm - 48VDC

**310,00 €**

**0074A2** Servizio doppia accensione  
Dual switch service - Service Doppelzündung

**50,00 €**

**C005T2NE** Custom black cable

**8,00 € /MT**

[Configura](#)  Configure / Konfigurieren

[www.teamitaliailluminazione.it](http://www.teamitaliailluminazione.it) 



 A 2700K 

**CODICE COMPLETO DEL PRODOTTO NELLA FOTO**  
FULL PRODUCT CODE AS SHOWN IN PICTURE - VOLLSTÄNDIGER CODE VOM ARTIKEL IM BILD

**T3082A48** **NE** **E2** **B**

Codice  
Code

Finitura  
Finishing  
Lackierung

Diffusore  
Diffuser  
Diffusor

Tonalità  
Hue  
Farbton

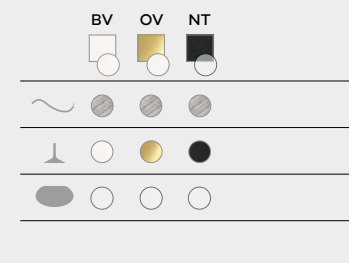

**TF** Taglio di Fase - Phase-Cut Dimmer - Phasenabschnittdimmer

**A** Alimentatore nel rosone - Power Supply inside the ceiling rose - Netzteil in der Deckendose

\* 680lm effettivi - effective - effektive con - with - mit **E2**





RV custom finish

configurazione standard: / basic configuration: / Standard Konfiguration:

**E28** Satinato  
Frosted - Satiniert

**B** 3000K

BV

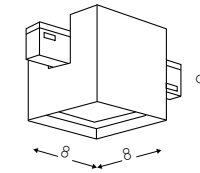

**T009A48NEE28B**

13W 1000lm\* - 48V DC

**199,00 €**



**0074A2**

Servizio doppia accensione  
Dual switch service - Service Doppelzündung

**50,00 €**

Configura 

Configure / Konfigurieren

[www.teamitaliailluminazione.it](http://www.teamitaliailluminazione.it) 

NE RU 



 Alimentatore non incluso - Power Supply not included - Netzteil nicht enthalten

\* 1000lm effettivi - effective - effektive con - with - mit **E28**

 **CODICE COMPLETO DEL PRODOTTO NELLA FOTO**  
FULL PRODUCT CODE AS SHOWN IN PICTURE - VOLLSTÄNDIGER CODE VOM ARTIKEL IM BILD

**T009A48** **RV** **E28** **B**

Codice  
Code

Finitura  
Finishing  
Lackierung

Diffusore  
Diffuser  
Diffusor

Tonalità  
Hue  
Farbton



# SISTEMA B48

OVERLAP DECÒ

configurazione standard: / basic configuration: / Standard Konfiguration:

E2 Opale - Opal

B 3000K

BV

T015I48BVE2B

75W 5500lm\* - 48V DC

780,00 €

Configura

Configure / Konfigurieren

[www.teamitaliailluminazione.it](http://www.teamitaliailluminazione.it)

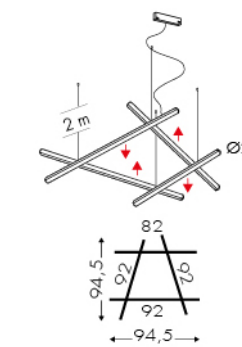
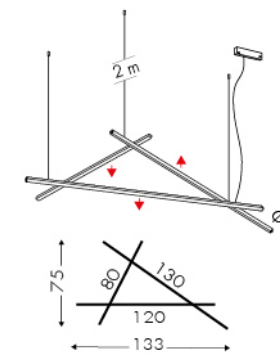

T015L48BVE2B

75W 5500lm - 48VDC

780,00 €

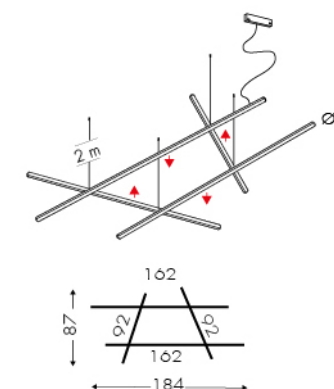

T015M48BVE2B

110W 8500lm - 48V DC

890,00 €



0074A2

Servizio doppia accensione  
Dual switch service - Service Doppelzündung

50,00 €

Configura

Configure / Konfigurieren

[www.teamitaliailluminazione.it](http://www.teamitaliailluminazione.it)



CODICE COMPLETO DEL PRODOTTO NELLA FOTO  
FULL PRODUCT CODE AS SHOWN IN PICTURE - VOLLSTÄNDIGER CODE VOM ARTIKEL IM BILD

**T015L48**

**RV**

**E2**

**B**

Codice  
Code

Finitura  
Finishing  
Lackierung

Diffusore  
Diffuser  
Diffusor

Tonalità  
Hue  
Farbton



Alimentatore non incluso - Power Supply not included - Netzteil nicht enthalten

\* 5500lm effettivi - effective - effektive con - with - mit E2

# SISTEMA B48



configurazione standard: / basic configuration: / Standard Konfiguration:

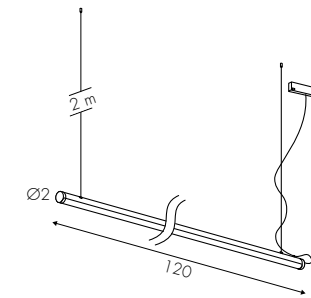

E2 Opale - Opal ● B 3000K BV

**T015C48BVE2B** 28W - 1890lm\* - 48V DC

**335,00 €**

Configura  Configure / Konfigurieren

[www.teamitaliailluminazione.it](http://www.teamitaliailluminazione.it) 

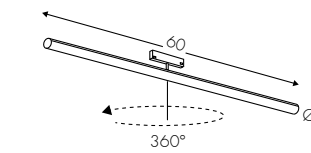

**T015B48BVE2B** 12W - 850lm - 48V DC

**240,00 €**



**0074A2**

Servizio doppia accensione  
Dual switch service - Service Doppelzündung

**50,00 €**

Configura  Configure / Konfigurieren

[www.teamitaliailluminazione.it](http://www.teamitaliailluminazione.it) 



 **CODICE COMPLETO DEL PRODOTTO NELLA FOTO**  
FULL PRODUCT CODE AS SHOWN IN PICTURE - VOLLSTÄNDIGER CODE VOM ARTIKEL IM BILD

**T015C48** **RV** **E2** **B**

Codice  
Code

Finitura  
Finishing  
Lackierung

Diffusore  
Diffuser  
Diffusor

Tonalità  
Hue  
Farbton

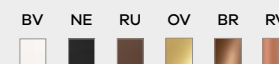

 Alimentatore non incluso - Power Supply not included - Netzteil nicht enthalten

\* 1890lm effettivi - effective - effektive con - with - mit E2



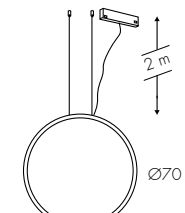
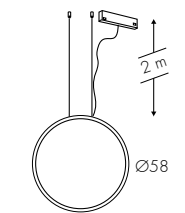
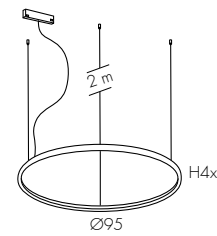
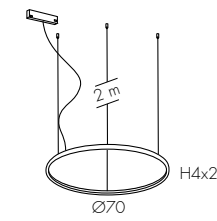

configurazione standard: / basic configuration: / Standard Konfiguration:

E2 Opale - Opal  B 3000K  BV

**T068B48BVE2B** 49W 3440lm\* - 48V DC **595,00 €**

**T068C48BVE2B** 66W 5630lm - 48V DC **695,00 €**

[Configura](#)  Configure / Konfigurieren

[www.teamitaliailluminazione.it](http://www.teamitaliailluminazione.it) 



configurazione standard: / basic configuration: / Standard Konfiguration:

E2 Opale - Opal  B 3000K  BV

**T068O48BVE2B** 39W 2680lm - 48V DC **520,00 €**

**T068E48BVE2B** 49W 3440lm - 48V DC **695,00 €**

**0074A2** Servizio doppia accensione / Dual switch service - Service Doppelzündung **50,00 €**

[Configura](#)  Configure / Konfigurieren

[www.teamitaliailluminazione.it](http://www.teamitaliailluminazione.it) 



 **CODICE COMPLETO DEL PRODOTTO NELLA FOTO**  
FULL PRODUCT CODE AS SHOWN IN PICTURE - VOLLSTÄNDIGER CODE VOM ARTIKEL IM BILD

**T068E48** **OV** **E2** **B**

Codice Code  
Finitura Finishing Lackierung  
Diffusore Diffuser Diffusor  
Tonalità Hue Farbton

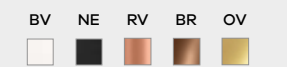

 Alimentatore non incluso - Power Supply not included - Netzteil nicht enthalten

\* 3440lm effettivi - effective - effektive con - with - mit **E2**

# SISTEMA B48

SPOTLIGHT 



configurazione standard: / basic configuration: / Standard Konfiguration:

24° Ottica - Optic - Optik  B 3000K

BV

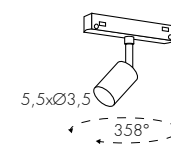

**T018B48BV24B** 4W 380lm\* 48V DC

128,00 €

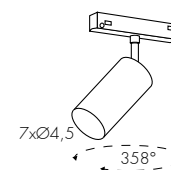

**T018C48BV24B** 7W 550lm 48V DC

131,00 €

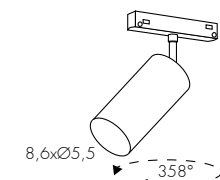

**T018D48BV24B** 12W 850lm 48V DC

145,00 €

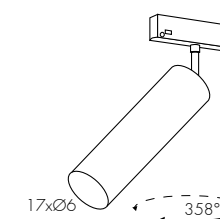

**T018E48BV24B** 18W 1280lm 48V DC

193,00 €



**0074A2** Servizio doppia accensione  
Dual switch service - Service Doppelzündung

50,00 €

Configura  Configure / Konfigurieren

[www.teamitaliailluminazione.it](http://www.teamitaliailluminazione.it) 



NE

 CODICE COMPLETO DEL PRODOTTO NELLA FOTO  
FULL PRODUCT CODE AS SHOWN IN PICTURE - VOLLSTÄNDIGER CODE VOM ARTIKEL IM BILD

**T018C48** **NE** **24** **B**

Codice  
Code

Finitura  
Finishing  
Lackierung

Diffusore  
Diffuser  
Diffusor

Tonalità  
Hue  
Farbton

 Alimentatore non incluso - Power Supply not included - Netzteil nicht enthalten

\* 380lm effettivi - effective - effektiven con - with - mit 24°

 INDEX

 SECTION

 FAMILY 537

# SISTEMA B48

TUBÍCO 



configurazione standard: / basic configuration: / Standard Konfiguration:

E8 Trasparente - Transparent  B 3000K 

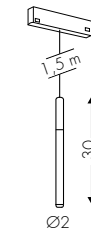

**T069A48ONE8B**

3W 350lm\* - 48V DC

**235,00 €**



**T069B48ONE8B**

3W 350lm - 48V DC

**252,00 €**

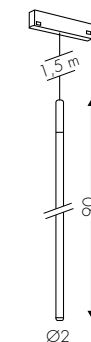

**T069C48ONE8B**

3W 350lm - 48V DC

**265,00 €**



**0074A2**

Servizio doppia accensione  
Dual switch service - Service Doppelzündung

**50,00 €**

Configura  Configure / Konfigurieren

[www.teamitaliailluminazione.it](http://www.teamitaliailluminazione.it) 



E19 

 Alimentatore non incluso - Power Supply not included - Netzteil nicht enthalten

\* 350lm effettivi - effective - effektiven con - with - mit **E8**



 **CODICE COMPLETO DEL PRODOTTO NELLA FOTO**  
FULL PRODUCT CODE AS SHOWN IN PICTURE  
VOLLSTÄNDIGER CODE VOM ARTIKEL IM BILD

**T069B48** **ZN** **E19** **B**

Codice Code	Finitura Finishing Lackierung	Diffusore Diffuser Diffusor	Tonalità Hue Farbton
----------------	-------------------------------------	-----------------------------------	----------------------------

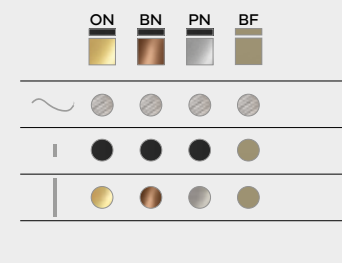

 INDEX

 SECTION

 FAMILY 539



# SISTEMA B48



configurazione standard: / basic configuration: / Standard Konfiguration:

E2 Opale  
Opal - Opal

 B 3000K

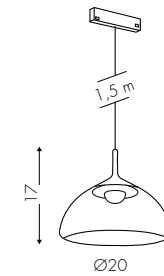

**T064A48NTE2B**

6.5W 800lm\* - 48V DC

**350,00 €**

Configura 

Configure / Konfigurieren

[www.teamitaliailluminazione.it](http://www.teamitaliailluminazione.it) 

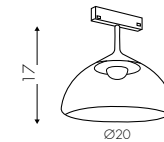

**T064F48NTE2B**

6.5W 800lm - 48V DC

**350,00 €**



**0074A2**

Servizio doppia accensione  
Dual switch service - Service Doppelzündung

**50,00 €**

Configura 

Configure / Konfigurieren

[www.teamitaliailluminazione.it](http://www.teamitaliailluminazione.it) 



 **CODICE COMPLETO DEL PRODOTTO NELLA FOTO**  
FULL PRODUCT CODE AS SHOWN IN PICTURE - VOLLSTÄNDIGER CODE VOM ARTIKEL IM BILD

**T064A48** **NF** **E2** **B**

Codice  
Code

Finitura  
Finishing  
Lackierung

Diffusore  
Diffuser  
Diffusor

Tonalità  
Hue  
Farbton

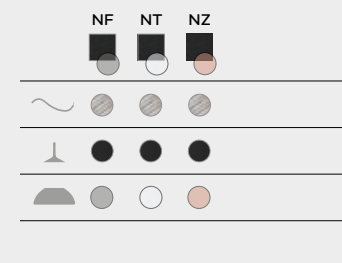

 Alimentatore non incluso - Power Supply not included - Netzteil nicht enthalten

\* 800lm effettivi - effective - effektiven con - with - mit **E2**

Sistemi di Gestione della luce  
Light Management Systems  
Lichtsteuersysteme



 Dimmer BT

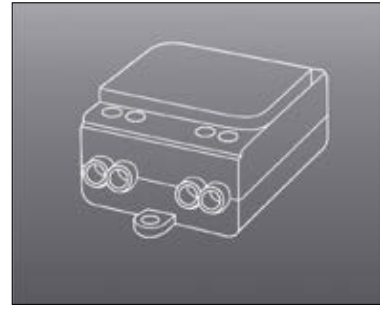

**BLC** 546  
Bluetooth Light Control

 Dimmer Dali

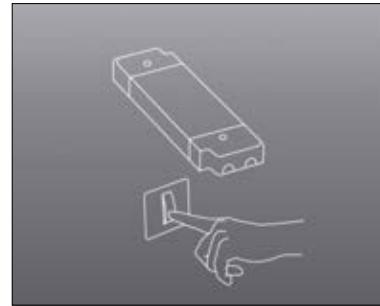

**PLC** 547  
Push Light Control

 RLC



**RLC** Remote Light Control 548  
Gestione della luce monocromatica



**RLC** Remote Light Control 548  
Gestione della luce caldo/freddo



**RLC** Remote Light Control 548  
Gestione della luce RGB

 WLC



**WLC** Wall Light Control 551  
Sistema di gestione per scatola 503



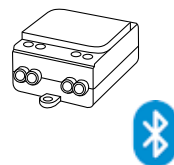

## 9010BTMD

Dispositivo Bluetooth per rendere dimmerabili Wireless da remoto i nostri prodotti in versione "DM" (DALI).

Our products DM dimmable (DALI) products are compatible with Tridonic module for remote bluetooth dimming.

Bluetooth-Gerät, um unsere "DM" (DALI) Produkte Wireless dimmbar zu machen.

163,00 €

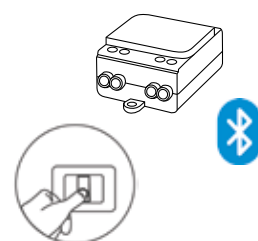

## 9010BTPD

Dispositivo per rendere Bluetooth un pulsante normalmente aperto.

Device to make Bluetooth a button normally open.

Gerät, um Bluetooth zu einer normalweise geöffneten Taste zu machen.

163,00 €

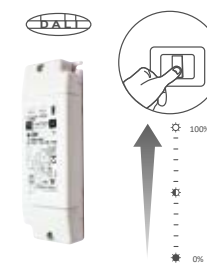
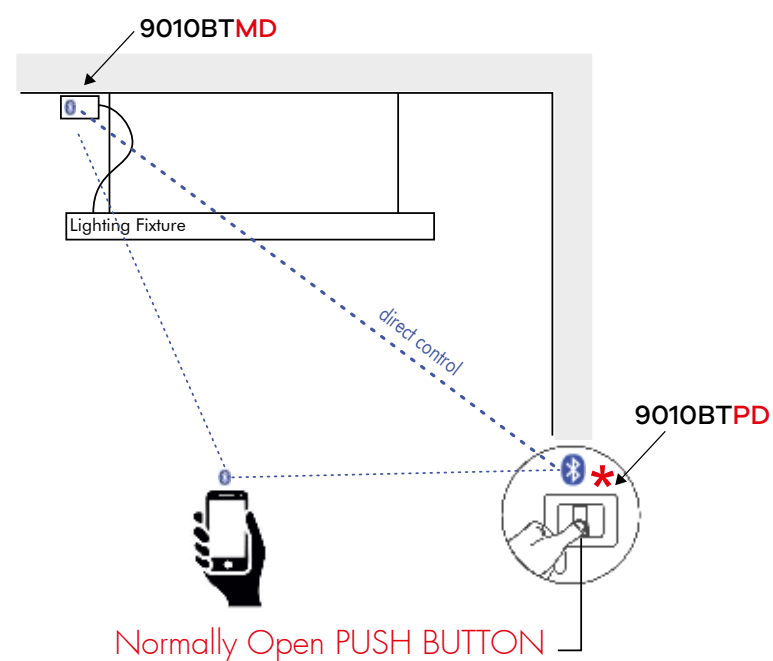

Max 10A 12/24VDC

## 90106002

Dispositivo per la gestione di sorgenti led a luce monocromatica con Pulsante o con sistema Domotico DALI.

Monochromatic led light manager with button or DALI domotic system.

Gerät für die Verwaltung von monochromatischem Led-Lichtquellen mit Druckknopfschaltung oder DALI Domotik.

79,00 €

Dispositivi necessari - Necessary devices - Notwendige Geräte



CODICE COMPLETO • COMPLETE CODE • VOLLSTÄNDIGE CODE

**9010BTMD**

Codice  
Code

CODICE COMPLETO • COMPLETE CODE • VOLLSTÄNDIGE CODE

**90106002**

Codice  
Code

Dispositivi necessari/Necessary Devices/  
Notwendige Geräte

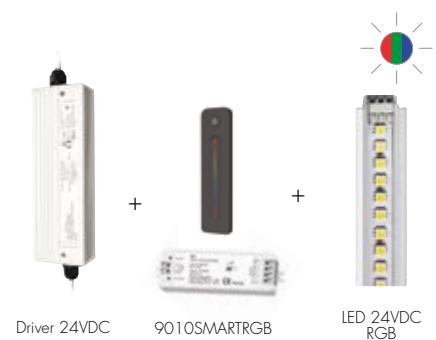
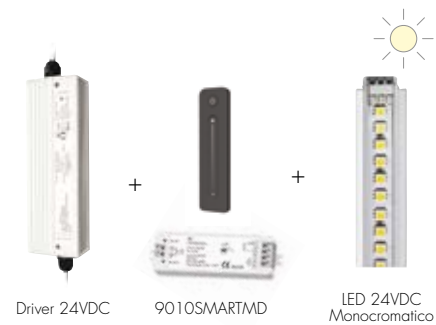

## 9010SMARTMD

Dispositivo per la gestione di sorgenti led a luce monocromatica con Radiocomando.

Monochromatic Led light remote control.  
Gerät für die Verwaltung von monochromatischem Led-Lichtquellen mit Fernsteuerung.

74,00 €

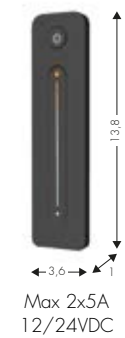

## 9010SMARTCW

Dispositivo per la gestione di sorgenti led a luce calda/fredda con Radiocomando.

Twin-white Led light remote control.  
Gerät für die Verwaltung von Led Quellen zum warm bis kalt Licht mit Fernsteuerung.

86,00 €

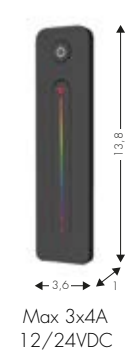

## 9010SMARTRGB

Dispositivo per la gestione di sorgenti led a luce RGB con Radiocomando.

RGB led light remote control.  
Gerät für die Verwaltung von RGB Led-Lichtquellen mit Fernsteuerung.

86,00 €

CODICE COMPLETO • COMPLETE CODE • VOLLSTÄNDIGE CODE

**9010SMARTMD**

Codice  
Code



## 9010MD2CH

494,00 €



Dimmerazione di 2 canali  
Two channel dimming  
Zwei Kanäle Dimmer

Dispositivi necessari - Necessary devices - Notwendige Geräte

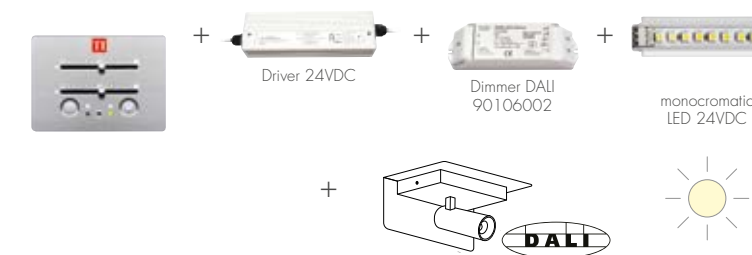

CODICE COMPLETO • COMPLETE CODE • VOLLSTÄNDIGE CODE

**9010MD2CH**

Codice  
Code





## 9010CW

Dispositivo per la gestione di sorgenti LED a luce calda/fredda.  
Twin-white LED light control device.  
Gerät für die Verwaltung von LED Lichtquellen zum warm bis kalt.

494,00 €

Dispositivi necessari - Necessary devices - Notwendige Geräte



## 9010RGB

Dispositivo per la gestione di sorgenti LED a luce RGB.  
RGB LED light control device.  
RGB Lichtsteuergerät.

494,00 €

Dispositivi necessari - Necessary devices - Notwendige Geräte



CODICE COMPLETO • COMPLETE CODE • VOLLSTÄNDIGE CODE

**9010CW**

Codice  
Code



## 9010SM

494,00 €



Dispositivo di coordinamento dei sistemi WallLight Control per la creazione di scenari luminosi. Per scatola 503.

WallLight control devices coordinator and scene manager. For 503 electric box.

Gerät, das die Wand-Managementsysteme koordiniert und Lichtszenen erstellt. Für 503 Gehäuse.

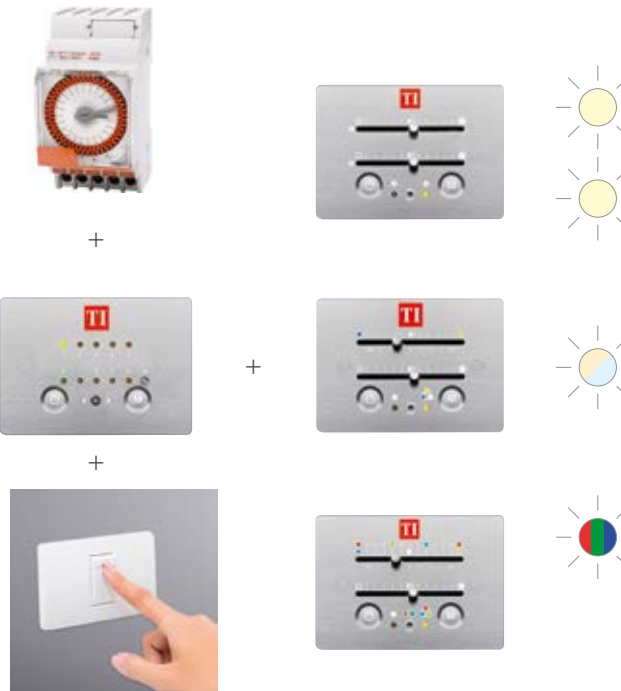

CODICE COMPLETO • COMPLETE CODE • VOLLSTÄNDIGE CODE

**9010SM**

Codice  
Code



Accessori  
Accessoires  
Zubehör

10A



IP65

V- (BLACK) ○

V+ (RED) ○







Striped

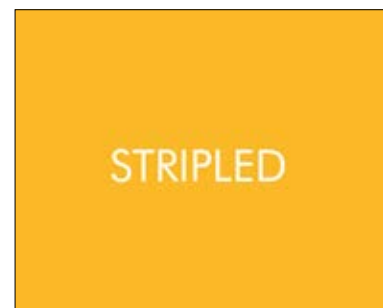

**Stripled**  
stripled IP20 562



**Stripled**  
stripled IP65 562

Drivers CC

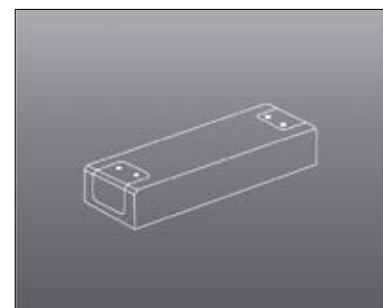

**Alimentatori CC On/Off** 564

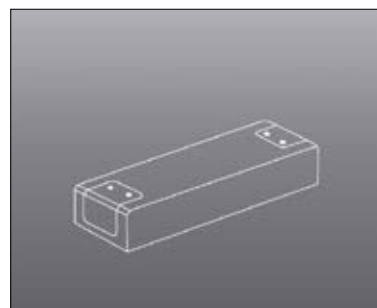

**Alimentatori CC Triac** 564

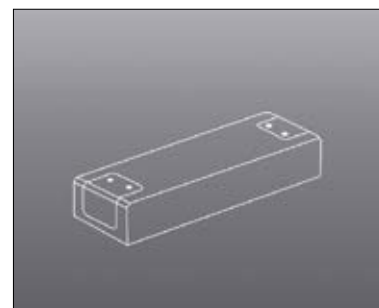

**Alimentatori DALI (Push)** 564

Drivers CV 24V

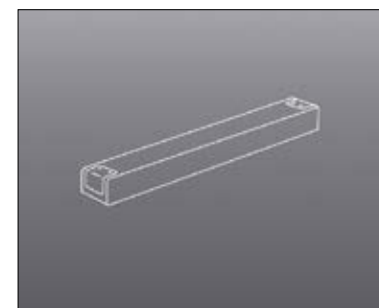

**Alimentatori CV 24V On/Off** 565

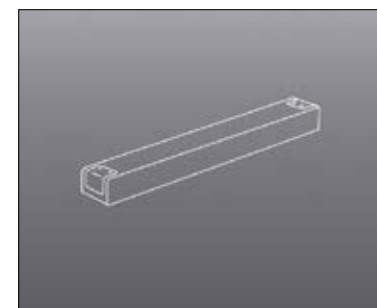

**Alimentatori CV 24V Triac** 565

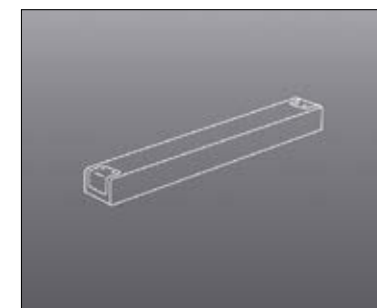

**Alimentatori CV 24V DALI** 565

Drivers CV 48V

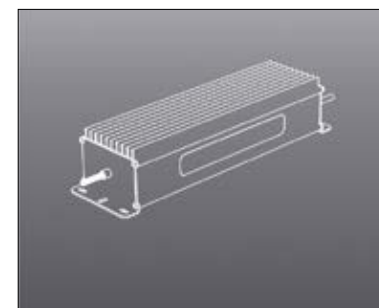

**Alimentatori CV 48V Triac** 565



Guidecavo

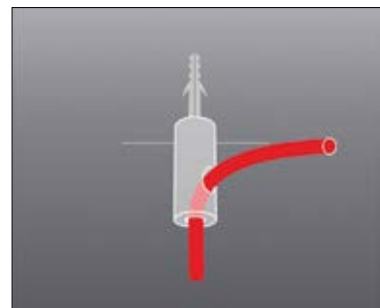

**Guidecavo**  
Guide cavo verticale

567

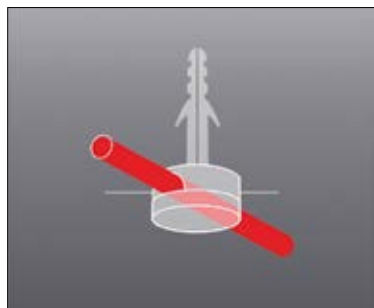

**Guidecavo**  
Guide cavo orizzontale

567



Cavi alimentazione/Power cord



**White**  
Cavi alimentazione in tessuto

567



**Black**  
Cavi alimentazione in tessuto

567



**Red**  
Cavi alimentazione in tessuto

567



**Transparent**  
Cavi alimentazione in teflon

567



Rosoni / Canopy

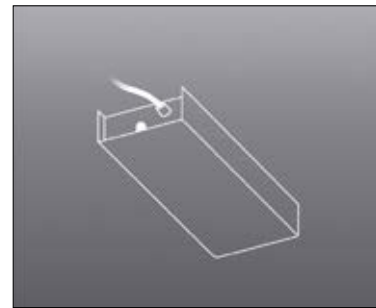

**Rosoni**

568



**Rosoni**

569

## STRIPLED IP20

14.4W/mt



	<b>90101427K20MT</b>	14,4W 1900lm/mt - 24VDC 2700K IP20 (1mt)	<b>13,00 €</b> /mt + S.M.
	<b>90101430K20MT</b>	14,4W 1900lm/mt - 24VDC 3000K IP20 (1mt)	<b>13,00 €</b> /mt + S.M.
	<b>90101440K20MT</b>	14,4W 1900lm/mt - 24VDC 4000K IP20 (1mt)	<b>13,00 €</b> /mt + S.M.
	<b>901014RGB20MT</b>	14,4W 600lm/mt - 24VDC RGB IP20 (1mt)	<b>14,00 €</b> /mt + S.M.

[Configura](#) [Configure / Konfigurieren](#) [www.teamitaliailluminazione.it](http://www.teamitaliailluminazione.it)

22W/mt



	<b>90102227K20MT</b>	22W 2880lm/mt - 24VDC 2700K IP20 (1mt)	<b>32,00 €</b> /mt + S.M.
	<b>90102230K20MT</b>	22W 2880lm/mt - 24VDC 3000K IP20 (1mt)	<b>32,00 €</b> /mt + S.M.
	<b>90102240K20MT</b>	22W 2880lm/mt - 24VDC 4000K IP20 (1mt)	<b>32,00 €</b> /mt + S.M.



[Configura](#) [Configure / Konfigurieren](#) [www.teamitaliailluminazione.it](http://www.teamitaliailluminazione.it)

## STRIPLED IP65

14.4W/mt



	<b>90101427K65MT</b>	14,4W 1900lm/mt - 24VDC 2700K IP65 (1mt)	<b>15,00 €</b> /mt + S.M.
	<b>90101430K65MT</b>	14,4W 1900lm/mt - 24VDC 3000K IP65 (1mt)	<b>15,00 €</b> /mt + S.M.
	<b>90101440K65MT</b>	14,4W 1900lm/mt - 24VDC 4000K IP65 (1mt)	<b>15,00 €</b> /mt + S.M.
	<b>901014RGB65MT</b>	14,4W 600lm/mt - 24VDC RGB IP65 (1mt)	<b>16,00 €</b> /mt + S.M.

[Configura](#) [Configure / Konfigurieren](#) [www.teamitaliailluminazione.it](http://www.teamitaliailluminazione.it)

22W/mt



	<b>90102227K65MT</b>	22W 2880lm/mt - 24VDC 2700K IP65 (1mt)	<b>37,00 €</b> /mt + S.M.
	<b>90102230K65MT</b>	22W 2880lm/mt - 24VDC 3000K IP65 (1mt)	<b>37,00 €</b> /mt + S.M.
	<b>90102240K65MT</b>	22W 2880lm/mt - 24VDC 4000K IP65 (1mt)	<b>37,00 €</b> /mt + S.M.



[Configura](#) [Configure / Konfigurieren](#) [www.teamitaliailluminazione.it](http://www.teamitaliailluminazione.it)

\*SERVIZIO SU MISURA (S.M.)



**001001A** Taglio strip e saldatura - Cut service and soldering **12,00 €**

## ROLLA 5MT IP20

14.4W/mt



	<b>90101442700</b>	14,4W 1900lm/mt - 24VDC 2700K IP20 (5mt)	<b>60,00 €</b>
	<b>90101443000</b>	14,4W 1900lm/mt - 24VDC 3000K IP20 (5mt)	<b>60,00 €</b>
	<b>90101444000</b>	14,4W 1900lm/mt - 24VDC 4000K IP20 (5mt)	<b>60,00 €</b>
	<b>9010144RGB</b>	14,4W 600lm/mt - 24VDC RGB IP20 (5mt)	<b>66,00 €</b>

[Configura](#) [Configure / Konfigurieren](#) [www.teamitaliailluminazione.it](http://www.teamitaliailluminazione.it)

22W/mt



	<b>9010222700</b>	22W 2880lm/mt - 24VDC 2700K IP20 (5mt)	<b>152,00 €</b>
	<b>9010223000</b>	22W 2880lm/mt - 24VDC 3000K IP20 (5mt)	<b>152,00 €</b>
	<b>9010224000</b>	22W 2880lm/mt - 24VDC 4000K IP20 (5mt)	<b>152,00 €</b>



[Configura](#) [Configure / Konfigurieren](#) [www.teamitaliailluminazione.it](http://www.teamitaliailluminazione.it)

## ROLLA 5MT IP65

14.4W/mt



	<b>90101442700IP65</b>	14,4W 1900lm/mt - 24VDC 2700K IP65 (5mt)	<b>72,00 €</b>
	<b>90101443000IP65</b>	14,4W 1900lm/mt - 24VDC 3000K IP65 (5mt)	<b>72,00 €</b>
	<b>90101444000IP65</b>	14,4W 1900lm/mt - 24VDC 4000K IP65 (5mt)	<b>72,00 €</b>
	<b>9010144RGBIP65</b>	14,4W 600lm/mt - 24VDC RGB IP65 (5mt)	<b>79,00 €</b>

[Configura](#) [Configure / Konfigurieren](#) [www.teamitaliailluminazione.it](http://www.teamitaliailluminazione.it)

22W/mt



	<b>9010222700IP65</b>	22W 2880lm/mt - 24VDC 2700K IP65 (5mt)	<b>180,00 €</b>
	<b>9010223000IP65</b>	22W 2880lm/mt - 24VDC 3000K IP65 (5mt)	<b>180,00 €</b>
	<b>9010224000IP65</b>	22W 2880lm/mt - 24VDC 4000K IP65 (5mt)	<b>180,00 €</b>



[Configura](#) [Configure / Konfigurieren](#) [www.teamitaliailluminazione.it](http://www.teamitaliailluminazione.it)

CODICE COMPLETO • COMPLETE CODE • VOLLSTÄNDIGE CODE

4 X **90101427K20MT** + 1 X **001001A**  
STRIPLED SERVICE

CODICE COMPLETO • COMPLETE CODE • VOLLSTÄNDIGE CODE

4 X **90101427K65MT** + 1 X **001001A**  
ROLLA SERVICE



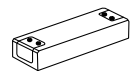

## ON/OFF

<b>AE006A</b>	Driver 10W - On/Off 350mA / 35V / IP20	<b>16,00 €</b>
<b>AE006B</b>	Driver 16W - On/Off 350mA / 12-44V / IP20	<b>28,00 €</b>
<b>AE006C</b>	Driver 35W - On/Off 500mA / 50-100V IP20	<b>26,00 €</b>
<b>AE006D</b>	Driver 9W - On/Off 250mA / 5-36V IP20	<b>22,00 €</b>
<b>AE006E</b>	Driver 6W - On/Off 150mA / 5-40V IP20	<b>22,00 €</b>
<b>AE006F</b>	Driver 20W - On/Off 500mA / 12-44V IP20	<b>27,00 €</b>
<b>AE006G</b>	Driver 24W - On/Off 200-700mA / 3-42V IP20	<b>35,00 €</b>
<b>AE006H</b>	Driver 30W - On/Off 700mA / 20-42V IP20	<b>31,00 €</b>
<b>AE006I</b>	Driver 4W - On/Off 350mA / 3-12V / IP65	<b>13,00 €</b>
<b>AE006L</b>	Driver 10W - On/Off 350mA / 2-28,5V IP65	<b>100,00 €</b>
<b>AE006M</b>	Driver 18W - On/Off 350mA / 2-49V IP65	<b>59,00 €</b>
<b>AE006N</b>	Driver 34W - On/Off 300-700mA / IP20	<b>30,00 €</b>
<b>AE006O</b>	Driver 15W - On/Off 350-725mA / IP20	<b>32,00 €</b>

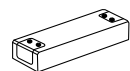

## TRIAC

<b>AE007F</b>	Driver 25W - Triac 250-700mA / 15-49V IP20	<b>56,00 €</b>
<b>AE008A</b>	Driver 10W - Triac 350mA / 12-28V IP20	<b>26,00 €</b>
<b>AE008B</b>	Driver 18W - Triac 350mA / 25-51V IP20	<b>26,00 €</b>
<b>AE008C</b>	Driver 40W - Triac 350mA / 53-108V IP20	<b>24,00 €</b>
<b>AE008D</b>	Driver 10W - Triac 350mA / 3-42V IP20	<b>18,00 €</b>
<b>AE008E</b>	Driver 21W - Triac 300-500mA / 28-42V IP20	<b>24,00 €</b>
<b>AE008F</b>	Driver 20W - Triac 150-700mA / 7-44V IP20	<b>44,00 €</b>
<b>AE008G</b>	Driver 20W - Triac 180-350mA / 28-42V IP20	<b>25,00 €</b>
<b>AE008H</b>	Driver 20W - Triac 250-900mA / 15-48V IP20	<b>46,00 €</b>

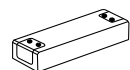

## DALI (Push)

<b>AE007A</b>	Driver 30W - DALI(Push) 250-700mA / 2-54V IP20	<b>65,00 €</b>
<b>AE007B</b>	Driver 25W - DALI(Push) 350-1050mA / 20-50V IP20	<b>62,00 €</b>
<b>AE007C</b>	Driver 10W - DALI(Push) 150-400mA / 15-40V IP20	<b>55,00 €</b>
<b>AE007E</b>	Driver 38W - DALI(Push) 300-1050mA / 10-54V IP20	<b>58,00 €</b>

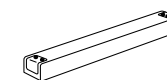

## 24V ON/OFF

<b>AE003A</b>	Driver 30W - On/Off 24V / IP20	<b>29,00 €</b>
<b>AE003B</b>	Driver 75W - On/Off 24V / IP20	<b>45,00 €</b>
<b>AE003C</b>	Driver 100W - On/Off 24V / IP65	<b>74,00 €</b>
<b>AE003D</b>	Driver 150W - On/Off 24V / IP65	<b>98,00 €</b>
<b>AE003E</b>	Driver 240W - On/Off 24V / IP65	<b>127,00 €</b>
<b>AE003F</b>	Driver 36W - On/Off 24V / IP20	<b>34,00 €</b>
<b>AE003G</b>	Driver 75W - On/Off 24V / IP65	<b>52,00 €</b>
<b>AE003H</b>	Driver 60W - On/Off 24V / IP20	<b>38,00 €</b>
<b>AE003I</b>	Driver 30W - On/Off 24V / IP65	<b>47,00 €</b>

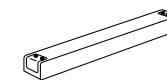

## 24V DALI

<b>AE004A</b>	Driver 150W - DALI (No-Push) 24V / IP65	<b>113,00 €</b>
---------------	---	-----------------



## 24V TRIAC

<b>AE005A</b>	Driver 100W - Triac 24V / IP20	<b>124,00 €</b>
<b>AE005B</b>	Driver 200W - Triac 24V / IP65	<b>198,00 €</b>

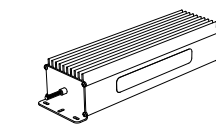

## 48V TRIAC

<b>AE016A</b>	Driver 100W - Triac 48V / IP65	<b>230,00 €</b>
<b>AE016B</b>	Driver 150W - Triac 48V / IP65	<b>300,00 €</b>



CODICE COMPLETO • COMPLETE CODE • VOLLSTÄNDIGE CODE

**AE006I**

Codice  
Code

CODICE COMPLETO • COMPLETE CODE • VOLLSTÄNDIGE CODE

**AE003A**

Codice  
Code



TR

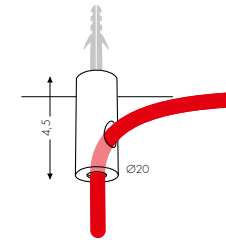

**90106014**

Guidacavi verticale  
Vertical cable guide  
Vertikal Kabelführung

**13,00 €**

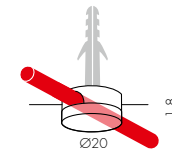

**90106015**

Guidacavi orizzontale  
Horizontal cable guide  
Horizontale Kabelführung

**11,00 €**

- **C005T2NE** Black cable **8,00 € /MT**
- **C005T2BV** White cable **8,00 € /MT**
- **C005T2RO** Red cable **8,00 € /MT**
- **C005A2TR** Transparent cable **7,00 € /MT**

CODICE COMPLETO • COMPLETE CODE • VOLLSTÄNDIGE CODE

**90106014**

Codice  
Code



BV NE  
□ ■

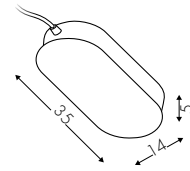

**AM004A**

Può contenere alimentatore: 75W  
It can contains power supply: 100W  
Es kann Netzteil enthalten: 150W  
240W

**68,00 €**

75W + 90106002  
100W + 90106002  
150W + 90106002  
240W + 90106002

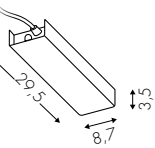

**9010XS**

Può contenere alimentatore: 30W/75W-24VDC  
It can contains power supply: 30W/75W-24VDC  
Es kann Netzteil enthalten: 30W/75W-24VDC

**72,00 €**

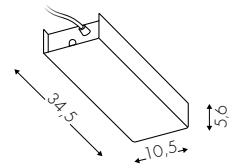

**9010M**

Può contenere alimentatore: 75W  
It can contains power supply: 100W  
Es kann Netzteil enthalten: 150W  
240W

**86,00 €**

75W + 90106002  
100W + 90106002  
150W + 90106002  
240W + 90106002

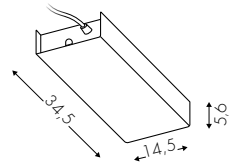

**9010L**

Può contenere alimentatore: 2x150W - 2x240W  
It can contains power supply: 2x150W - 2x240W  
Es kann Netzteil enthalten: 2x150W - 2x240W

**97,00 €**

BV NE  
□ ■



**AM003A**

Solo collegamento elettrico rotondo  
Only electrical connection round  
Nur elektrische Verbindung runden

**27,00 €**

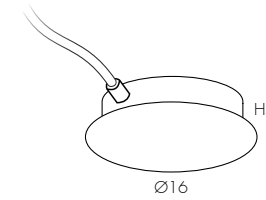

**AM003B**

Solo collegamento elettrico - può contenere bluetooth  
Only electrical connection - can contain bluetooth  
Nur elektrische Verbindung - kann Bluetooth enthalten

**58,00 €**

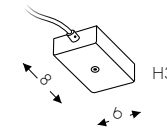

**AM002A**

Solo collegamento elettrico rettangolo  
Only electrical connection rectangle  
Nur elektrische Verbindung Rechteck

**28,00 €**

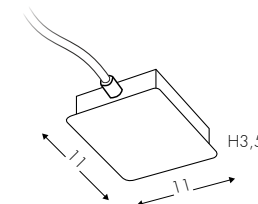

**AM002B**

Solo collegamento elettrico - può contenere bluetooth  
Only electrical connection - can contain bluetooth  
Nur elektrische Verbindung - kann Bluetooth enthalten

**28,00 €**

























CODICE COMPLETO • COMPLETE CODE • VOLLSTÄNDIGE CODE



**9010XS** **BV**

Codice  
Code

Finitura  
Finishing  
Lackierung



	Superiore diffusa Diffused uplight Obere verbreitung		Inferiore dominante + Superiore diffusa Diffused main emission downlight + Uplight Geringere hauptunterdiffusion + Obere verbreitung
	Superiore asimmetrica diffusa Diffused asymmetrical uplight Obere asymmetrisch verbreitung		Superiore diffusa + Inferiore concentrata Diffused uplight + Diffused downlight Obere verbreitung + Geringere konzentriertes
	Superiore concentrata Accent uplight Obere konzentriertes		Inferiore diffusa + Superiore asimmetrica concentrata Diffused Downlight + Accent asymmetrical uplight Geringere verbreitung + Obere asymmetrisch konzentriertes
	Superiore asimmetrica concentrata Accent asymmetrical uplight Obere asymmetrisch konzentriertes		Superiore concentrata + Inferiore concentrata Accent uplight + Accent downlight Obere konzentriertes + Geringere konzentriertes
	Inferiore diffusa Diffused downlight Geringere verbreitung		Superiore + Inferiore + Frontale diffusa Diffuse up + down + frontal light Obere + Geringere + front verbreitung
	Inferiore asimmetrica diffusa Accent asymmetrical downlight Geringere asymmetrisch verbreitung		Inferiore + Laterale diffusa Diffused side + Downlight Obere asymmetrisch konzentriertes
	Inferiore concentrata Accent downlight Geringere konzentriertes		360° diffusa Diffused all side light Auf vier seiten diffuses
	Inferiore asimmetrica concentrata Accent asymmetrical downlight Geringere asymmetrisch konzentriertes		Orientabile diffusa Diffused adjustable Verstellbar verbreitung
	Frontale diffusa Diffuse frontlight Diffuse front		Orientabile concentrata Accent adjustable Verstellbar konzentriertes
	Superiore diffusa + Inferiore diffusa Diffuse up-downlight Oben-unten diffusion		Orientabile concentrata + Superiore diffusa Accent adjustable + Diffuse up Verstellbar konzentriertes + Obere
	Indiretta posteriore Indirect back Indirektes Heck		Laterale asimmetrico Lateral Asymmetric Seitliche asymmetrische
	Indiretta posteriore + frontale Indirect back + front Indirektes Heck + Front		Laterale simmetrica Lateral symmetric Seitlich symmetrisch

	Indica che un prodotto può circolare liberamente all'interno dell'Unione Europea: Certifica che il prodotto risponde ai requisiti essenziali di sicurezza. Indicates that the product can circulate freely within the European Union: Certifies that the product meets the essential safety requirements. Gibt an, dass ein Produkt innerhalb der Europäischen Union frei im Umlauf sein kann: Bescheinigt, dass das Produkt den wesentlichen Sicherheitsanforderungen entspricht.
	Contatto a terra. Apparecchio in classe prima dotato solo dell'isolamento. Ground contact. Fixture in first class equipped only with insulation. Erdung Gerät in Klasse 1 nur mit Isolierung ausgerüstet.
	Classe II doppio isolamento e/o isolamento rinforzato senza dispositivo di messa a terra. Double insulation and/or reinforced insulation in every part and without ground devices. Doppelte Isolierung, bzw verstärkte Isolierung der Teile, ohne Vorrichtung für Erdung.
	Classe di protezione III - Apparecchi con bassa tensione protettiva. Apparecchi con protezione dallo shock elettrico attraverso la bassa tensione protettiva e che non funzionano con tensioni superiori. Protection class III - Devices with extra-low voltage. Devices with protection from electric shock through the low-voltage protection. They don't work with higher voltages. Schutzklasse III - Leuchten mit Kleinspannung. Geräte mit Schutz vor Stromschlag durch die Niederspannung. Sie arbeiten nicht mit höheren Spannungen.
	Apparecchio adatto al montaggio su superfici normalmente infiammabili. Suitable for mounting on normally inflammable surface. Das Gerät ist zur Installation auf entflammable Oberflächen geeignet.
	Protezione contro corpi estranei di medie dimensioni, nessuna protezione contro la penetrazione di acqua. Protection against medium-sized foreign bodies, no protection against water penetration. Schutz gegen mittelgroße Fremdkörper, ohne Schutz gegen Eindringen von Wasser.
	Protetto contro la polvere. Protetto da spruzzi di ogni tipo. Protected from dust ingress. Protected from water spray from any direction. Staubgeschützt. Schutz gegen Spritzwasser.
	Totalmente protetto contro la polvere. Protetto contro i getti d'acqua con lanci da tutte le direzioni. Protected from total dust ingress. Protected from high pressure water jets from any direction. Staubdicht. Schutz gegen starkes Strahlwasser.
	Totalmente protetto contro la polvere. Protetto contro le ondate. Protected from total dust ingress. Protected from high pressure water jets from any direction. Staubdicht. Schutz gegen starkes Strahlwasser.
	Totalmente protetto contro la polvere. Protetto contro gli effetti di immersione. Protected from total dust ingress. Protected from waves. Staubdicht. Schutz gegen eintauchen.
	Protetto contro energia d'urto 2J. Protected against impact energy 2J. Geschützt gegen Aufprallenergie 2J.
	Protetto contro energia d'urto 5J. Protected against impact energy 5J. Geschützt gegen Aufprallenergie 5J.



A 2700K

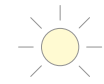

B 3000K

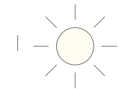

C 4000K

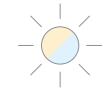

D 2700K-6500K



E RGB



Alimentatore Incorporato  
Incorporated Power Supply  
Eingebautes Netzteil



Alimentatore nel rosone  
Power Supply inside the ceiling rose  
Netzteil in der Deckendose



Alimentatore Incluso in remoto  
Included Power Supply in remote  
Einbezogen Netzteil



Alimentatore non incluso  
Power Supply not included  
Netzteil nicht inbegriffen



Sorgente GU10 non inclusa  
GU10 light source not included  
GU10 lichtquelle nicht einbezogen



Sorgente E27 non inclusa  
E27 light source not included  
E27 Lichtquelle nicht Enthalten

CAVO ALIMENTAZIONE  
ELECTRIC CABLE - STROMKABEL

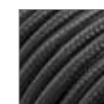

Nero - Black - Schwarz

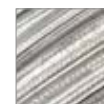

Trasparente - Transparent - Transparent

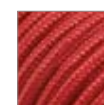

Rosso - Red - Rot



Bianco - White - Weiß

**BV**



Bianco  
White  
Weiß

**NE**



Nero  
Black  
Schwarz

**RU**



Ruggine  
Rust  
Rost

**BF**



Bronzo francese  
French bronze  
Französische Bronze

**OS**



Oro spazzolato  
Brushed Gold  
Gebürstetes Gold

**OV**



Oro verniciato  
Painted gold  
Gold lackiert

**RV**



Rame verniciato  
Painted copper  
Kupfer lackiert

**BR**

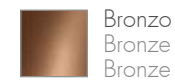

Bronzo  
Bronze  
Bronze

**NT**



Nero + Vetro trasparente  
Black + Clear glass  
Schwarz + Transparentem Glas

**SV**



Salvia  
Sage  
Salbei

**ZN**



Nero + Bronzo  
Black + Bronze  
Schwarz + Bronze

**OB**



Oro verniciato + Bianco  
Brushed Gold + White  
Gebürstetes Gold + Weiß

**ON**



Oro verniciato + Nero  
Brushed Gold + Black  
Gebürstetes Gold + Schwarz

**RN**



Rame verniciato + Nero  
Painted copper + Black  
Kupfer lackiert + Schwarz

**BN**



Nero + Bianco  
Black + White  
Schwarz + Weiß

**AB**



Argento + Bianco  
Silver + White  
Silber + Weiß

**AB**



Argento + Nero  
Silver + Black  
Silber + Schwarz

**PN**



Platino + Nero  
Platin + Black  
Platin + Schwarz

**NF**



Nero + Vetro fumè  
Black + Smoky glass  
Schwarz + Rauchglas

**BY**



Blu Navy  
Navy Blue  
Blu Navy

**SN**



Salvia + Nero  
Sage + Black  
Salbei + Schwarz

**CB**



Cromo + Bianco  
Chrome + White  
Chrom + Weiß

**BO**



Bianco + Ocre  
White + Ochre  
Weiß + Ocker

**BS**



Bianco + Salvia  
White + Sage  
Weiß + Salbei

**BB**



Bianco + Blu Navy  
White + Navy Blue  
Weiß + Blu Navy

**AL**



Alluminio  
Aluminum  
Aluminium

**PL**



Platino  
Platinum  
Platin

**GV**



Grigio verniciato  
Painted Grey  
Grau lackiert

**NZ**



Nero + Vetro bronzo  
Black + Bronze glass  
Schwarz + Glas bronze

**OC**



Ocre  
Ochre  
Ocker

**PREZZI:**

Unitari al pubblico **senza IVA (euro)**. I prezzi si intendono lampadine escluse, eccetto là dove specificatamente indicate incluse a listino.

**ECOCONTRIBUTO RAEE:**

In conformità alla direttiva che disciplina lo smaltimento di apparecchi elettrici ed elettronici (D.lgs 151/2005) si applica l'ecocontributo previsto dalla disposizione. Versati ove dovuti.

**ORDINI:**

Minimo l'ordine 200,00 (al netto di IVA e di sconti). L'accettazione è sempre soggetta all'approvazione della direzione con facoltà di effettuare spedizioni anche parziali, salvo esplicita indicazione da parte del committente.

**TERMINI DI CONSEGNA:**

I termini di consegna convenuti non sono impegnativi. Un eventuale ritardo non può dar luogo da parte del committente alla risoluzione dell'ordine, nè a qualsiasi pretesa di risarcimento danni. Team Italia ha la facoltà di sospendere la fornitura quando le condizioni economiche del cliente risultassero tali da porre in evidente pericolo il conseguimento del pagamento o per altri motivi di carattere commerciale e di gestione di Team Italia.

**PORTO:**

Porto franco per consegne di valore, al netto di IVA e di sconti, superiore a 600,00. (previo accordi)

**GARANZIA**

I prodotti Team Italia sono garantiti a norma di legge per due anni.

**RECLAMI**

I reclami per merce difettosa potranno essere accettati solo dietro la presentazione della copia del documento fiscale attestante l'acquisto e la corretta compilazione del modulo di reclamo da inviare entro 8 giorni dalla consegna del materiale. Team Italia si riserva il diritto di riparare e/o sostituire il prodotto difettoso con un altro prodotto simile o equivalente; sono esclusi costi di manodopera per la sostituzione degli apparecchi e comunque ogni danno, sia pure indirettamente, connesso con la difettosità dell'apparecchio.

**RESI:**

Eventuali resi dovranno essere da noi preventivamente autorizzati attendendosi alle istruzioni fornite.

**MODIFICHE:**

Fermo restando le caratteristiche basilari degli articoli, l'azienda si riserva di apportare eventuali modifiche per conformare alla normativa vigente e/o migliorare la qualità. Per ogni controversia è responsabile il Foro di Verona.

**IL PRESENTE CATALOGO ANNULLA E SOSTITUISCE OGNI PRECEDENTE.**

**PRICES:**

Unit prices for public **without VAT (euro)**. Prices do not include light bulbs, except where specifically indicated in the price list.

**ORDERS:**

Minimum order 200,00 net of VAT and discounts. Acceptance is always subject to approval by the management, who reserve the right to make split deliveries, except in the case of specific requirements set by the purchaser.

**DELIVERY TERMS:**

Agreed delivery deadlines are not binding. Eventual delays cannot be considered by the purchaser as a motive for withdrawing the order or for compensation for damages. Team Italia reserves the right to suspend shipments when the customer's financial conditions are such that payment of the invoice is at risk, or for other reasons based on Team Italia's commercial or management policies.

**SHIPPING FEES:**

Shipping costs, to be agreed, vary depending on the country of destination

**WARRANTY:**

Team Italia products are guaranteed for a period of 2 years.

**CLAIMS:**

Eventual claims or breakages must be reported within 8 days from the delivery of the goods. Claims for defective goods can only be considered, and the goods can be returned and repalced, only by presenting a copy of the fiscal document proving the relevant purchase, and filling the claim form supplied by Team Italia. Team Italia reserves the right to repair and/or replace the defective product with another similar or equivalent; Replacement labor costs of the devices are excluded and also any damage connected with the defectiveness of the device.

**RETURNS:**

Eventual returns must be authorised by us in advanced, in conformity with the instructions given.

**MODIFICATIONS:**

While the basic characteristics of the article remain unchanged, the company reserves the right to modify the products in order to conform with the regulations in force and/or to improve the quality. Any litigation will be dealt with by the Courts in Verona.

**THE PRESENT CATALOG REPLACES ALL PREVIOUS ONES.**

**PREISE:**

Einheitspreise **ohne MWVS (euro)**. Die preise verstehen sich ohne Glühbirnen, mit Ausnahme dort, wo sie im Verzeichnis ausdrücklich als inklusiv angegeben werden.

**AUFTRÄGE:**

Mindestauftrag Euro 200,00. Die Annahme ist immer vor der Zustimmung der Direktion abhängig mit der Befugnis, auch Teillieferungen vornehmen zu können, es sei denn, das ausdrückliche Hinweise seitens des Auftragsgebers bestehen.

**LIEFERTERMINE:**

Die vereinbarten Lieferungstermine sind unverbindlich. Eine eventuelle Verspätung gibt seitens des auftragsgebers weder anlass zur auftragsauflösung noch anspruch auf jeglichen Schadenersatz. Team Italia behält sich das Recht vor die Lieferung zu unterbrechen, sollte der finanzielle Zustand des Kunden die Zahlung offensichtlich gefährden oder aus anderen kommerzielle oder Leitungs-Gründen von Team Italia.

**VERSANDKOSTEN:**

Die zu vereinbarenden Versandkosten variieren je nach Bestimmungsland

**GARANTIE:**

Team Italia Produkte sind nach gesetzlichen Vorgaben 2 Jahre garantiert.

**BESCHWERDEN:**

Eventuelle Reklamationen oder Beschädigungen müssen nach Ablauf von 8 Tagen nach Warenerhalt schriftlich bekannt gegeben werden. Die Beschwerden für defekte Produkte können nur hinter Einreichung des Steuerbelegs, der den Kauf beschenigt, akzeptiert werden und nach der korrekten AStfüllung des Beschwerdeformulars der innerhalb 8 Tagen nach der Lieferung der Produkten einzusenden ist. Team Italia behält sich das Recht vor die defekte Produkte zu reparieren und/oder sie mit anderen ähnliche oder gleichwertige Produkten zu ersetzen. Die Arbeitskosten für den Ersatz der Geräte sind nicht mit inbegriffen, sowal auch nicht jegliche Schaden die auch indirekt mit dem Defekt des Produktes verbunden sind.

**RÜCKGABE DER WARE:**

Eventuelle Warenrückgaben müssen von uns autorisiert werden, wobei man sich an die beigelegten Anweisungen halten sollte.

**ÄNDERUNGEN:**

Die grundlegenden Charakteristiken der Artikel bleiben erhalten, der Betrieb behält sich jedoch vor, eventuelle Änderungen vorzunehmen, um das Produkt den gültigen Normen anzupassen und/oder die Qualität zu verbessern. Für alle Rechtsfragen ist der Gerichtsstand Verona zuständig.

**DIE VORLIEGENDE KATALOG ANNULLIERT UND ERSETZT ALLE VORHERGEHENDEN.**

**COPYRIGHTS**

Le immagini inserite sono a scopo illustrativo. Le caratteristiche ed i colori possono differire da quanto rappresentato" (es. sul retro copertina).

The pictures are only for illustrative purposes. The features and colors may be different from what shown "(e.g. on the back cover).

Die Bilder werden zu Erläuterungszwecken enthalten. Die Eigenschaften und Farben können von diesen Darstellungen unterscheiden "(z. B. auf der Rückseite).

Tutti i diritti riservati. Nessuna parte del presente catalogo può essere riprodotta o diffusa con fotocopie, microfilm, o con qualsiasi altro mezzo senza il permesso del titolare del copyright.

All rights reserved. None of this catalogue may be reproduced or diffused in the form of photocopies, microfilm or by any other means without the permission of the copyright owner.

Alle Rechte sind vorbehalten. Es ist nicht gestattet, den vorliegenden Katalog durch Kopierung, Mikrofilme oder jeglicher anderer Mittel ohne die Erlaubnis des Copyrightberechtigten zu drucken oder aber in Umlauf zu bringen.

L'azienda si riserva il diritto in qualunque momento di apportare senza preavviso modifiche a prodotti ed accessori.

The company reserves the right at any time without prior notice to make changes to products and accessories.

Die Firma behält sich das Recht vor, jederzeit ohne vorherige Ankündigung Änderungen an Produkten und Zubehör zu machen.



coordinatori Maurizio Pisani/Alessandro Sbrozzeri  
fotografia Massimo Branca  
fotolitografia Eurotipo srl  
illustrazioni Enrico Oliosì  
progetto grafico Enrico Oliosì  
stampa Eurotipo srl